

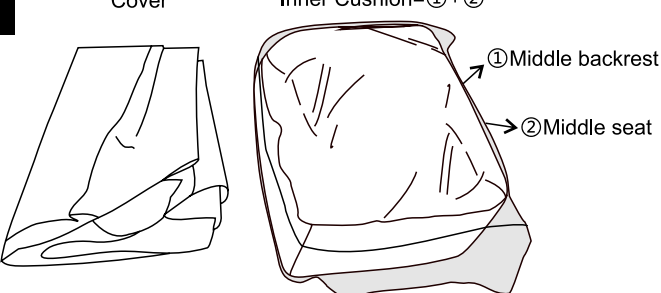

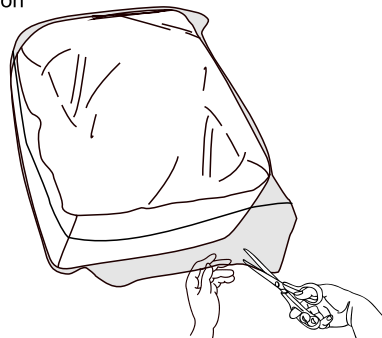

# MIDDLE CHAIR ASSEMBLY INSTRUCTION

**\* Read the instructions before installation.**

<p><b>1</b></p> <p>Cover      Inner Cushion=①+②</p>  <p>① Middle backrest ② Middle seat</p> <p>Check what included in the Box. <b>NOTES:</b> Do not use sharp objects to open the outer carton box.</p>	<p><b>2</b></p> <p>Inner Cushion</p>  <p>Unpacking the plastic bag.</p>
<p><b>3</b></p>  <p>Fully pat and shake the inner cushion for about 3 minutes ensure foam evenly filled in the nonwoven bag.</p>	<p><b>4</b></p>  <p>Check the sewing label attached on the nonwoven bag.</p>
<p><b>5</b></p> <p>Step 1 • Middle seat</p> <p>Step 2 • Backrest</p>  <p>Fully zip up.</p> <p>1. Kindly put middle seat cushion in the cover. 2. Fully zip up the seat zipper.</p>	<p><b>6</b></p> <p>Step 1 • Middle backrest</p> <p>Step 2 • Fully zip up.</p>  <p>1. Kindly put middle backrest cushion in the cover. 2. Fully zip up the zipper.</p>
<p><b>7</b></p>  <p>Place the sofa in an upright position, leave the inner cushion to expand for 48 hours. Pat and organize the outer shape of middle chair.</p>	<p><b>8</b></p>  <p>Now you get a perfect middle chair.</p>

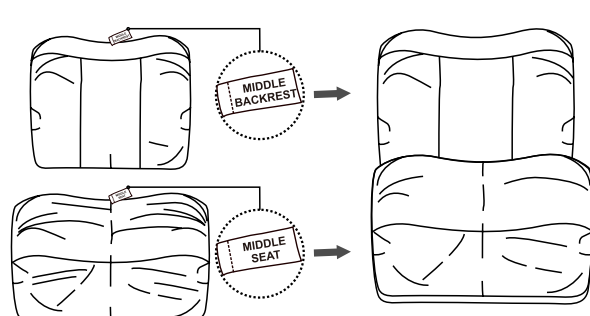
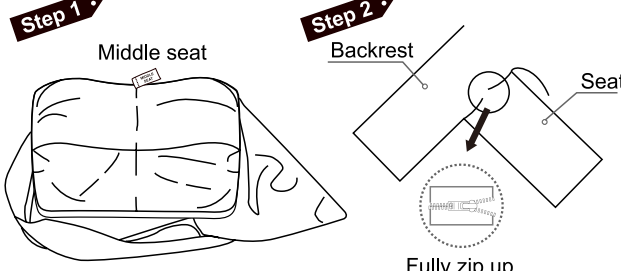
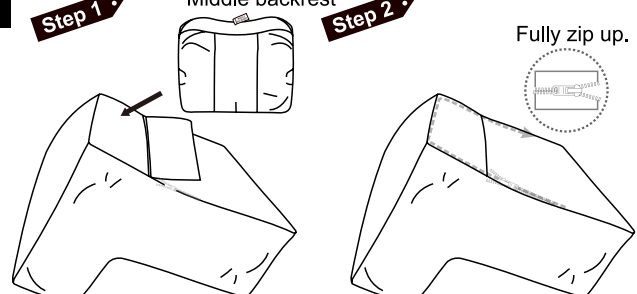
# CONNECTOR BUCKLE

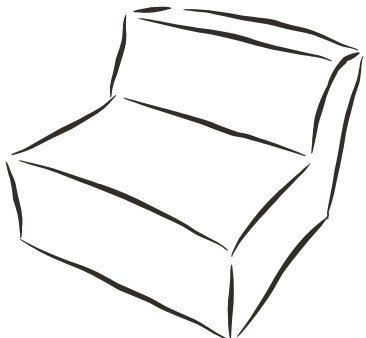
## ASSEMBLY INSTRUCTION

\* Read the instructions before installation.

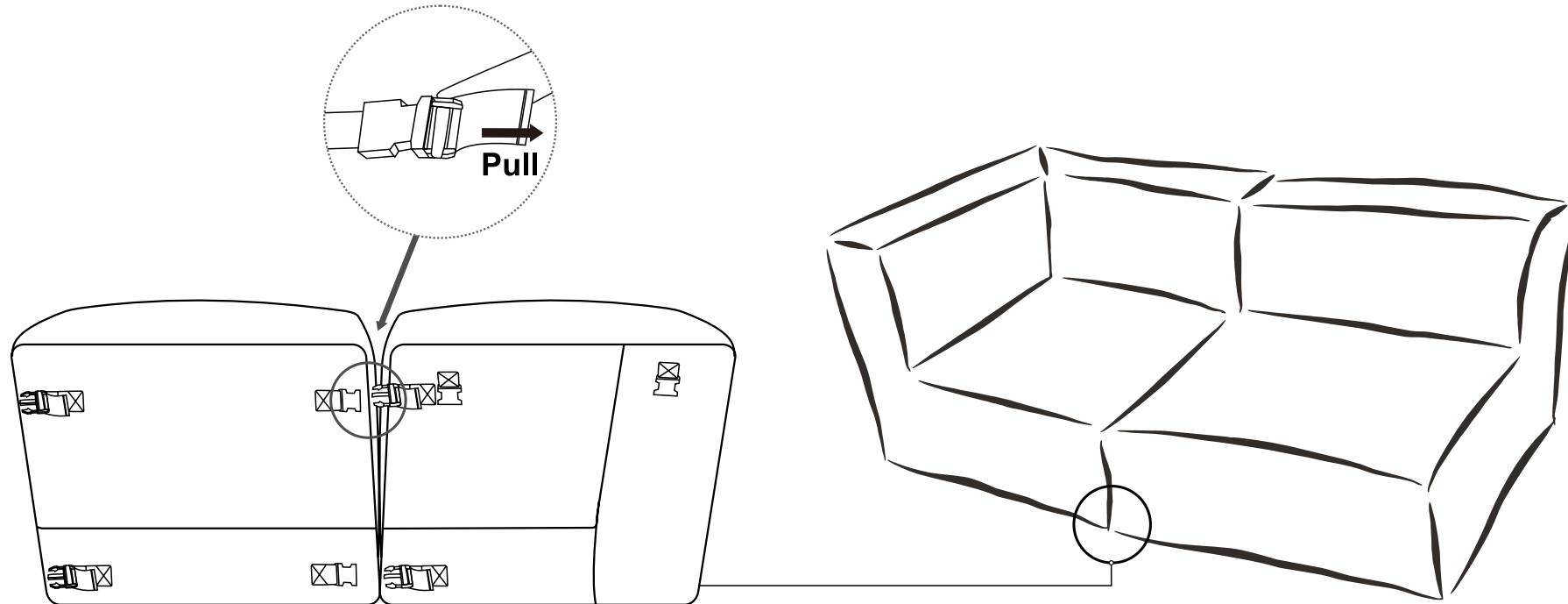

### HOW TO CONNECT?

Connect the buckle located at the bottom of the chair,  
and tighten the belt to a fit position to connect the two chairs.