

Assembly Instructions







MAINTENANCE AND WARNINGS



Before You Start

Please follow the steps below:

-  Check the packaging for any damage, deformation, or water stains. If there is significant damage, please contact us promptly.
-  Unpack the box and compare the contents with the parts list and hardware list to ensure all components and accessories are present and complete.
-  Please read the installation instructions carefully to understand the installation steps and precautions to ensure proper installation.
-  Clean the installation area in advance and ensure the ground is level and there is enough space to avoid damaging the furniture or making installation difficult.
-  Lay a protective mat on the ground to prevent scratching the floor during installation.

After-Sales Service

- If you encounter any issues or need technical support during use, please contact our after-sales team. We offer long-term maintenance and warranty services.

Parts list

Box A

A Back*1

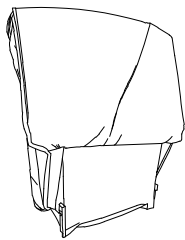

B Seat*1

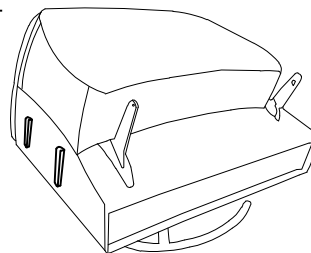

Box B

C Right armrest

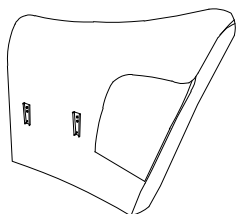

D Left armrest

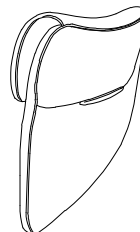

Step 1

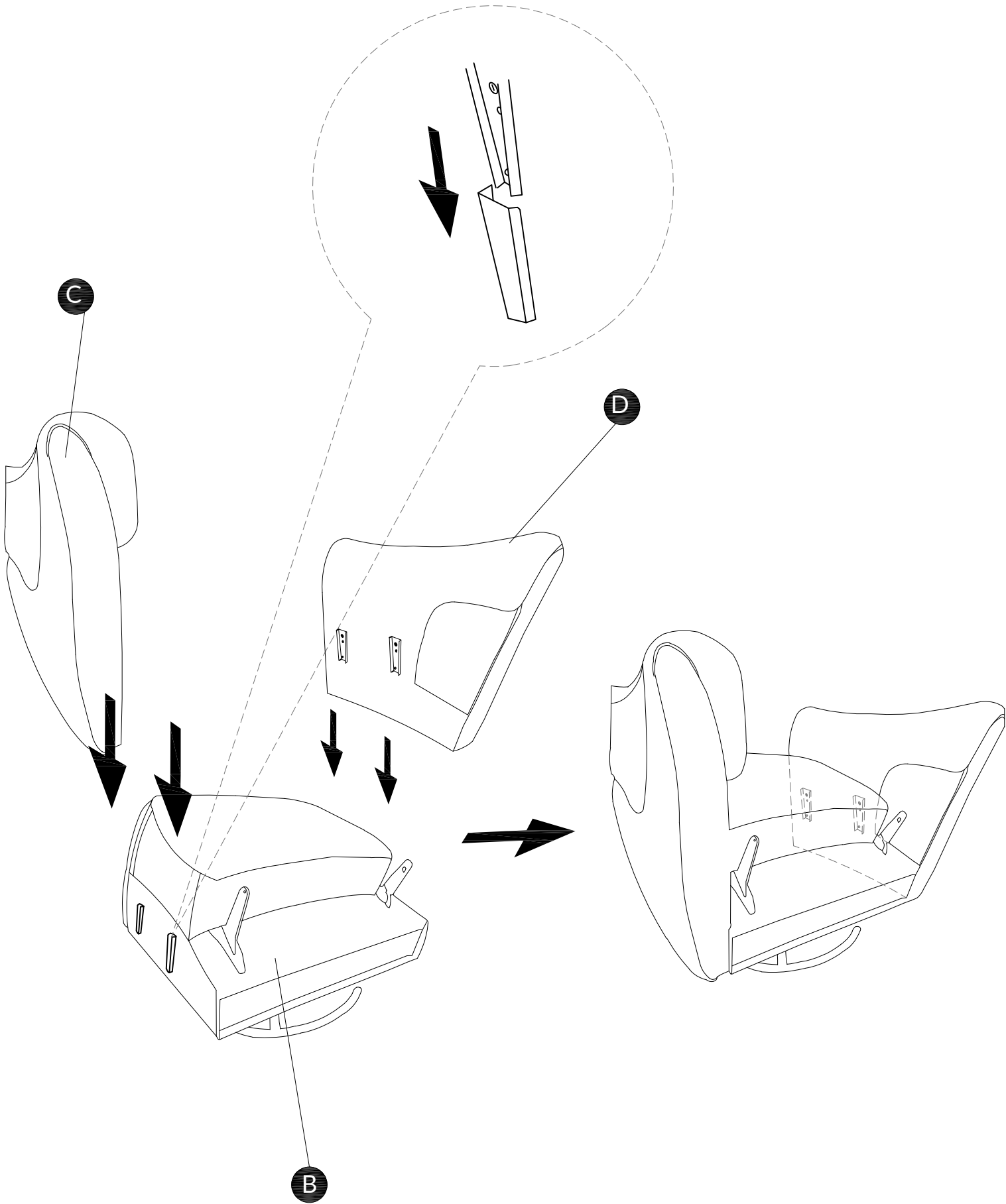

Step 2

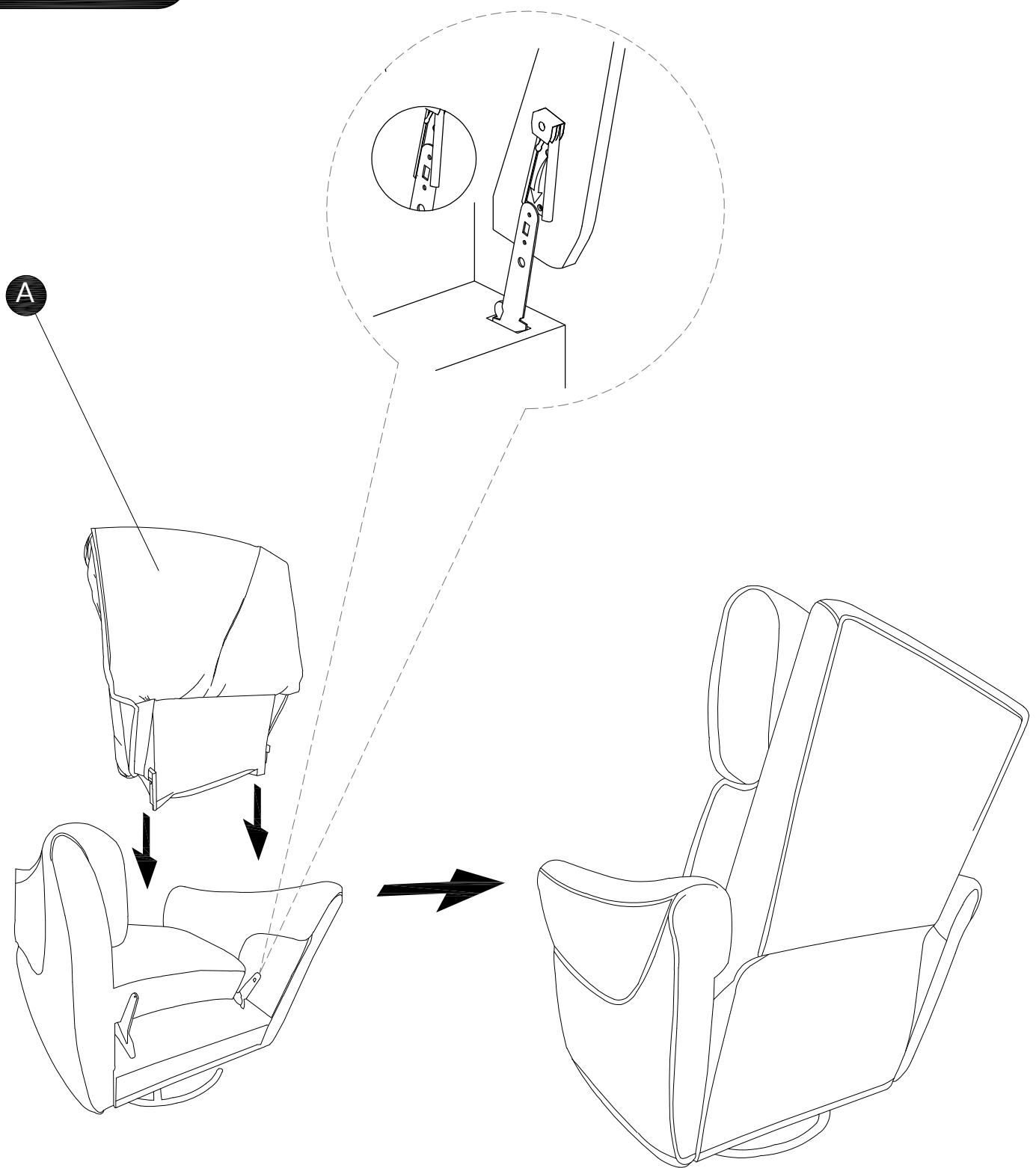

Step 3

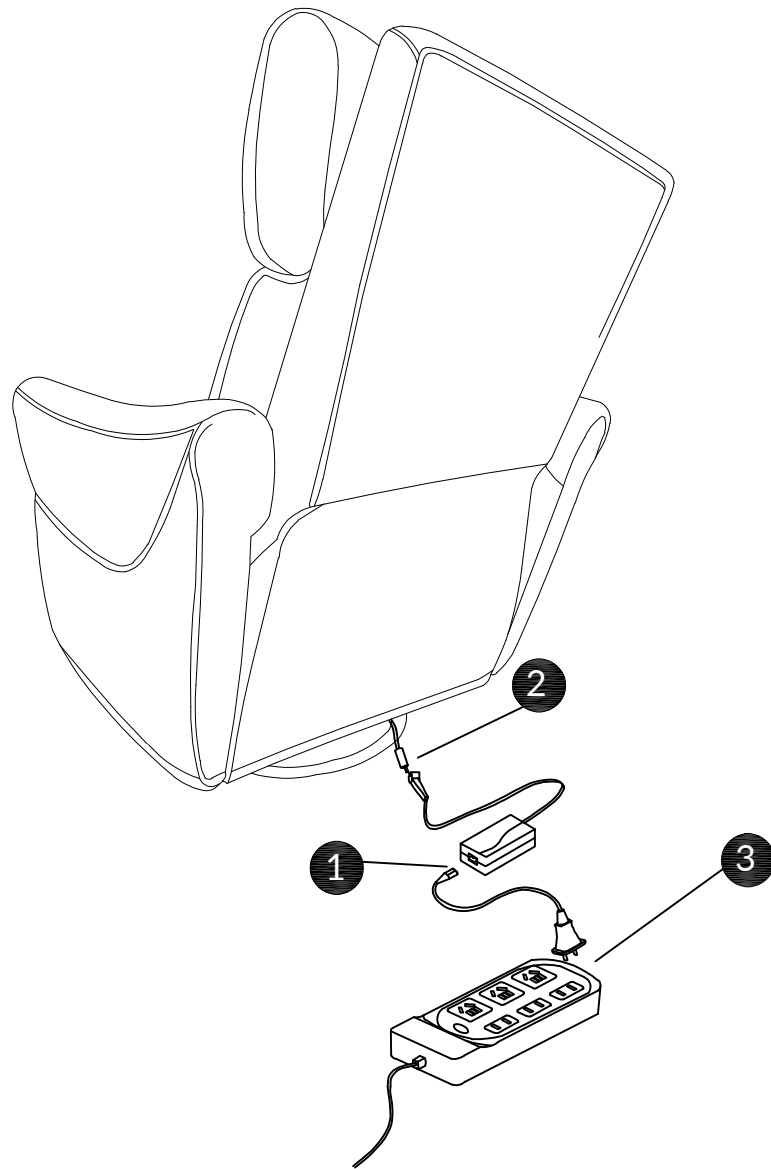

1

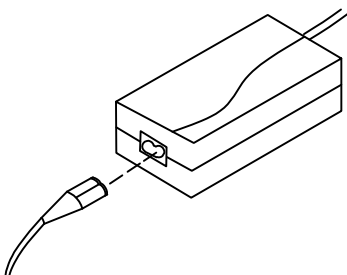

Connect

2

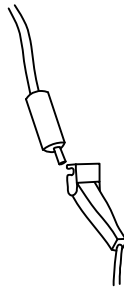

**Connect the adapter
cable to the bottom
cable of the sofa.**

3

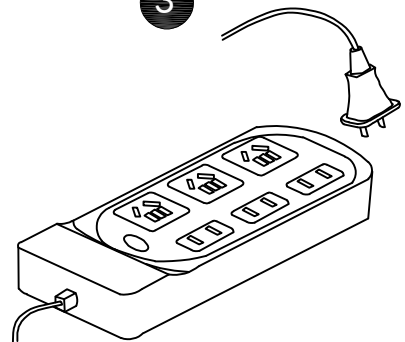

Power on the plug

Step 4

