

# Assembly Instruction

Item No.: F6953, F6954, F6955

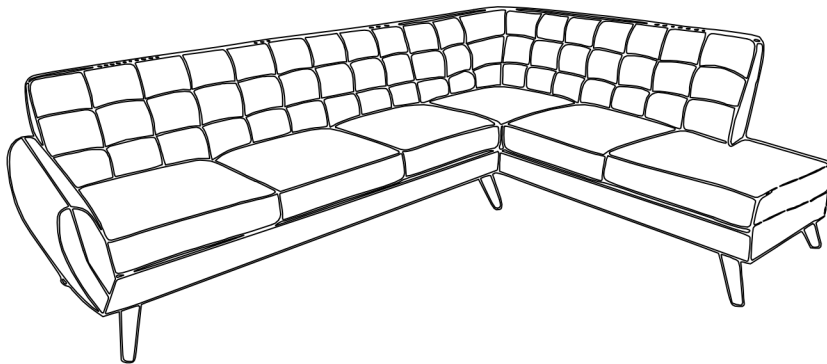

## PART LIST

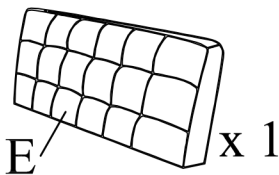
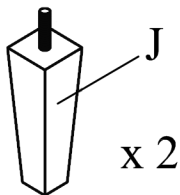
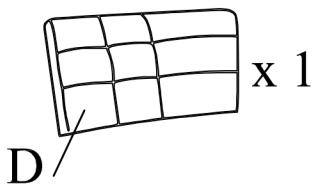
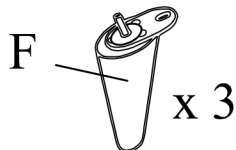
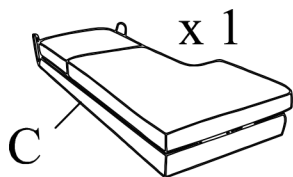

BOX 1:F6953-1, F6954-1, F6955-1

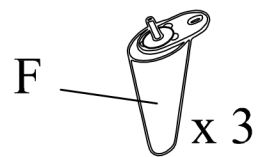
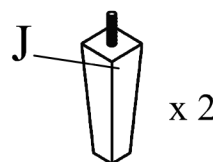
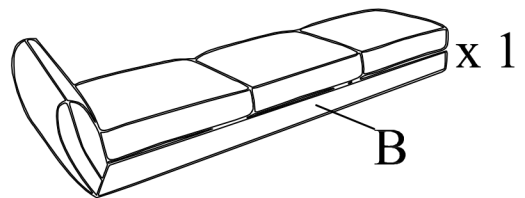
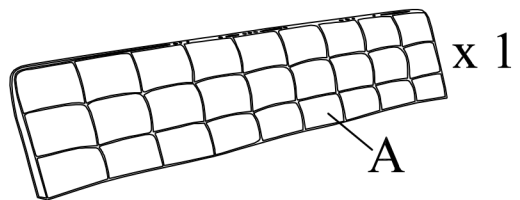

BOX 2:F6953-2, F6954-2, F6955-2



## HARDWARE LIST

<p>①  x 6</p> <p>Bolt 5/16" * 30mm</p>	<p>②  x 6</p> <p>Lock Washer Ø5/16"</p>	<p>③  x 6</p> <p>Flat Washer Ø5/16"</p>
---	--	--

<p>④  x1</p> <p>Allen Wrench M4</p>
--



Please follow the drawings below to assemble this item.

Step 1. Take out the legs from the inner box, and then rotate / tighten into the position at bottom of the left - facing sofa and the matching right - facing chaise as shown in below drawings.

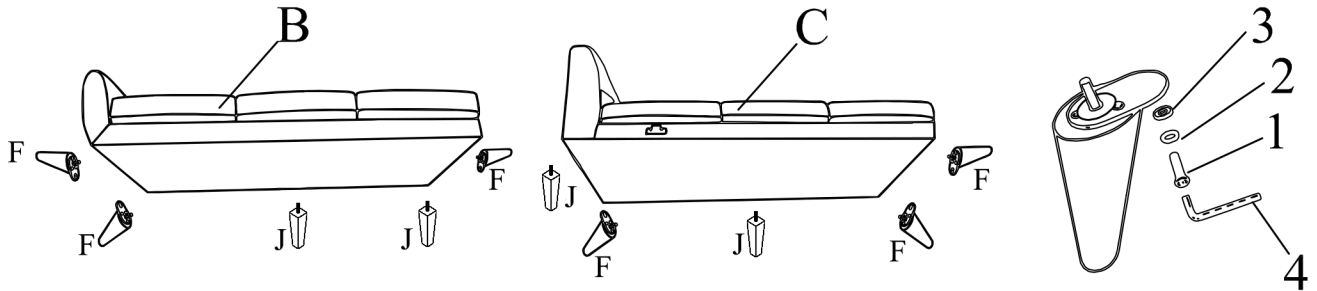

Step 2. Allign female brackets with the male one at the back & seat. And then insert / push the whole backrest to the seat. Make sure the brackets are secured in position before using.

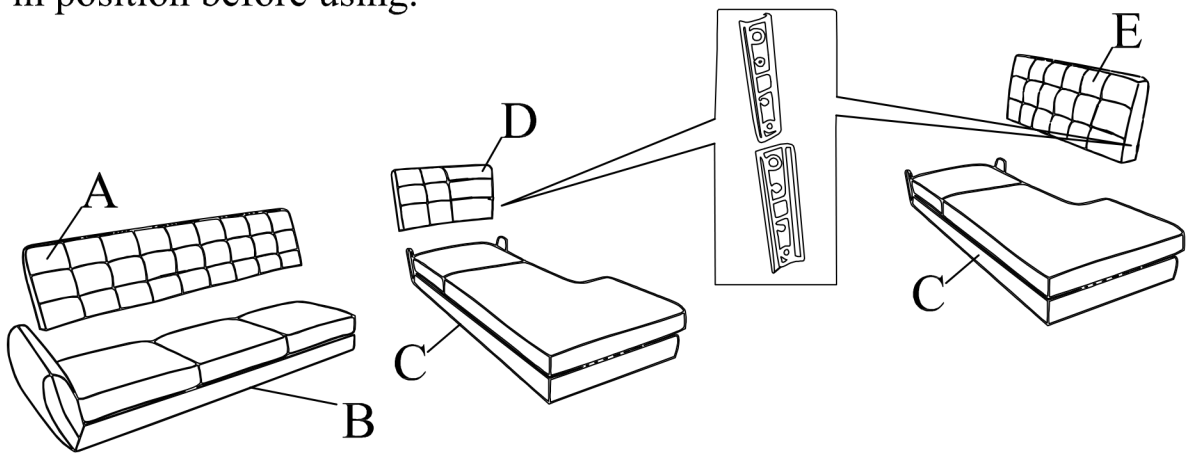

Step 3. Left - facing sofa and right - facing chaise can be attached together by the brackets as shown in below drawings.

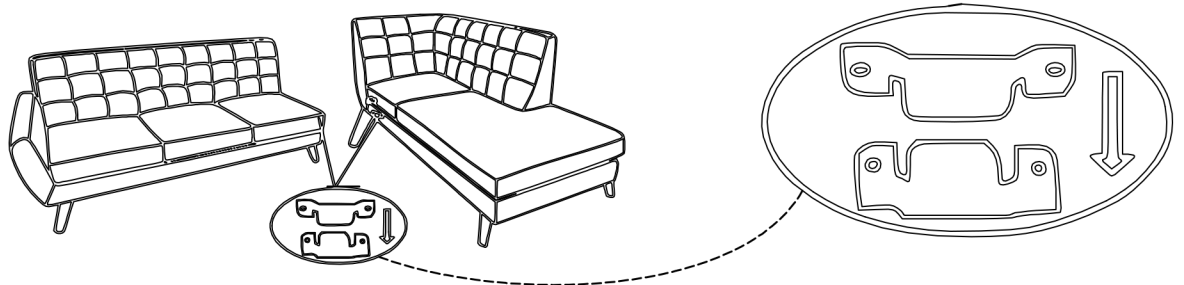

Step 4. Completed

