

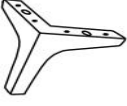







# Assembly Instruction

## Sofa

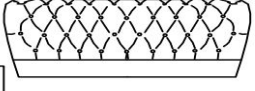
### PARTS LIST

				
A	$\times 4$ BL	$\times 1$ BR	$\times 1$	
				
C1	$\times 1$ C2	D	$\times 1$ E	$\times 2$
				
F	$\times 2$ G	$\times 16$		

STEP1

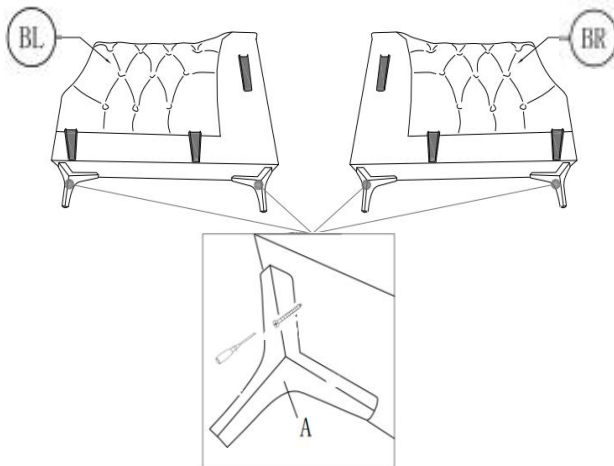

STEP2

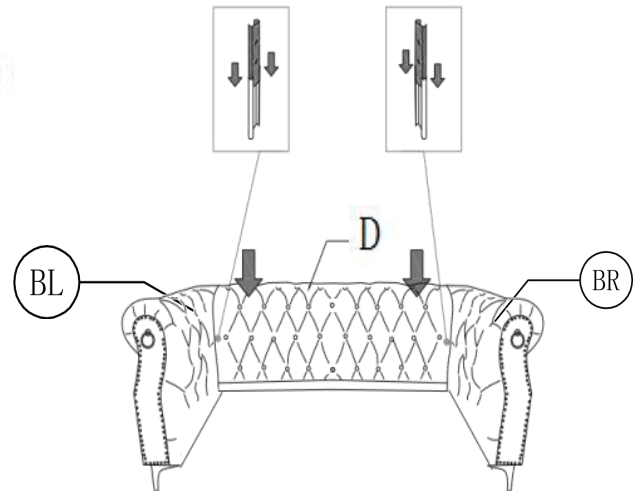

STEP3

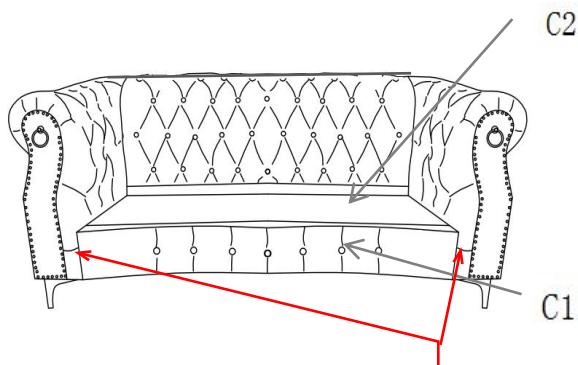

STEP4

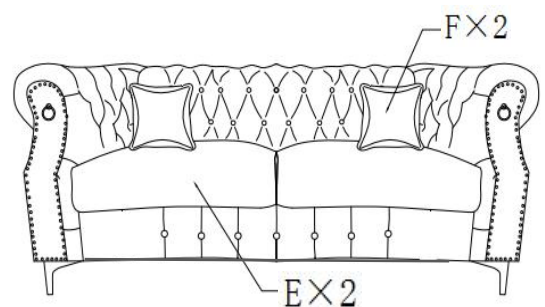

Tips: After Step 3, tighten the screws on bothsides.

