



BidetMate

Electronic Bidet Seat **USER MANUAL**



3000 SERIES

BM-3000P

This unit should be installed according to this manual. Read this manual carefully and install properly. Do not attempt to service this unit yourself. Doing so could void your warranty.

IMPORTANT SAFEGUARDS

When using electrical products, especially when children are present, basic safety precautions should always be followed, including the following:
READ ALL INSTRUCTIONS BEFORE USING.

WARNING– To reduce the risk of burns, electrocution, fire, or injury to persons.

1. Close supervision is necessary when this product is used by, on, or near children or individuals
2. Use this product only for its intended use as described in this manual. Do not use attachments not recommended by the manufacturer.
3. Never operate this product if it has a damaged cord or plug, if it is not working properly, if it has been dropped or damaged, or dropped into water. Return the product to a service center for examination and repair.
4. Keep the cord away from heated surfaces.
5. Never block the air openings of the product or place it on a soft surface, such as a bed or couch, where the air openings may be blocked. Keep the air openings free of lint, hair, and the like.
6. Never use while sleeping or drowsy.
7. Never drop or insert any object into any opening or hose.
8. Do not use outdoors or operate where aerosol (spray) products are being used or where oxygen is being administered.
10. Connect this product to a properly grounded outlet only. See Grounding Instructions.

SAVE THESE INSTRUCTIONS!

TABLE OF CONTENTS

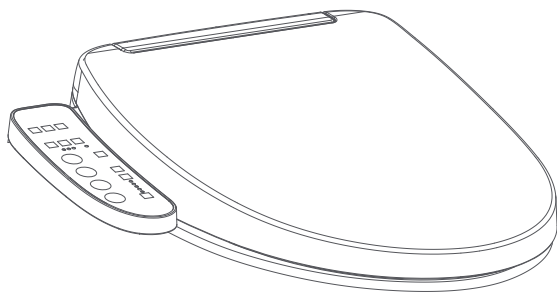

Features	1
Parts Information	2
Remote Control	3
Warnings & Safety	4
Installation	7
Function Explanations	11
Maintenance	14
Troubleshooting	15
Specifications	17

FEATURES

The functions may vary from different part no.

Category	Function	Model	BM-3000P
Cleaning	Unlimited washing		●
	Rear Wash		●
	Front Wash		●
	Bubble Cleaning		●
	Auto-cleaning		●
	Cleaning Back and Forth		●
	H/C Massage		●
	Water Pressure Regulation		●
	Water Temp Regulation		●
	Tube Position Adjustment		●
	Detachable Nozzle		●
	Nozzle Self-cleaning		●
	Nozzle Cleaning		●
Power Saving and Convenient	Seat Heating		●
	Warm Dry		●
	Damping Slow Down		●
	Seat Temp Regulation		●
	Wind Temp Regulation		●
	Night Light		●
	Frequency Instant Heating		●
Safe and Environmental Protection	Seat Ring Induction		●
	Memory Mode		●
	Power On Mode		●
	Filter Steel Mesh		●
	Air Isolation		●
	UV Sterilizer		●
	Prevent Cross-flow		●
	Nano-antibiotic		●
	Eight Safe Keeping		●
Flame and Heat Resistance		●	
Factory Reset		●	

Notice: ● Represents that the product have this function.

PARTS INFORMATION

PRODUCT OVERVIEW

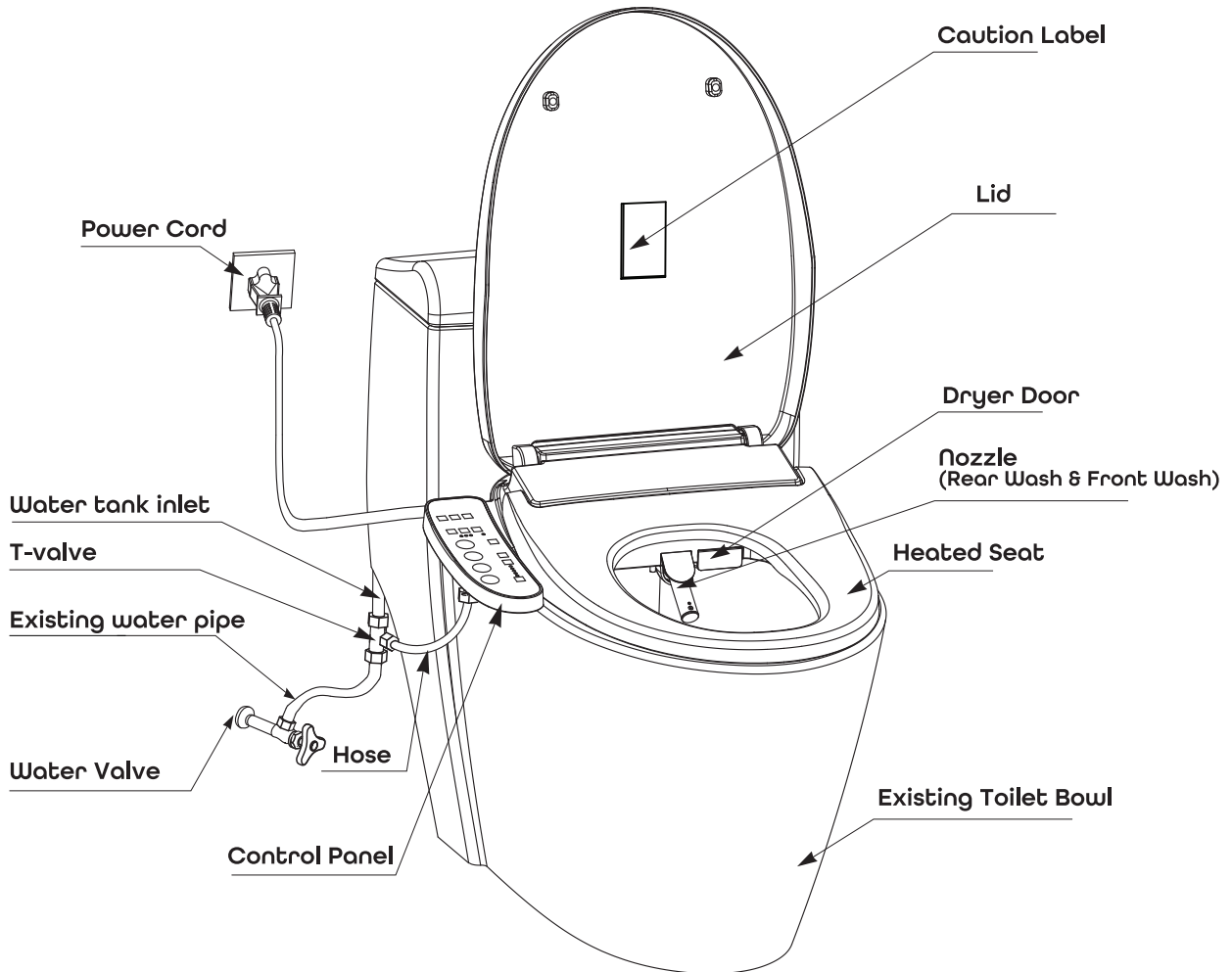

VIEW FROM THE RIGHT

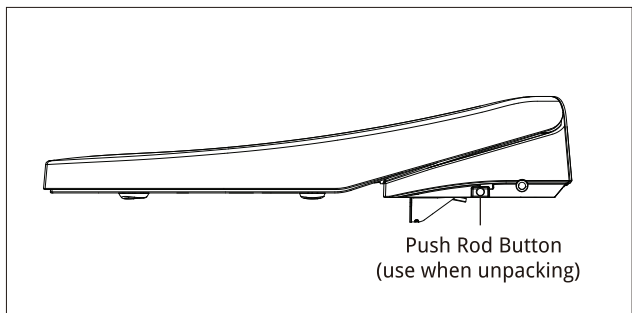

VIEW FROM THE LEFT

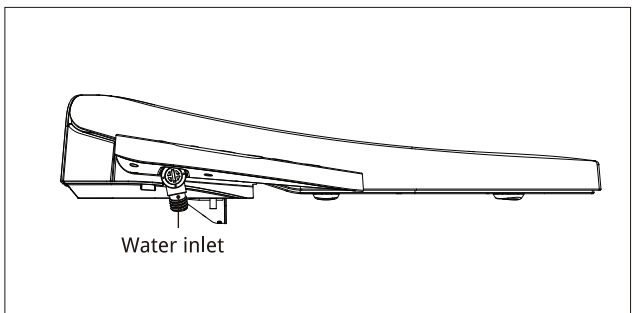

CONTROL PANEL

CONTROLS OVERVIEW

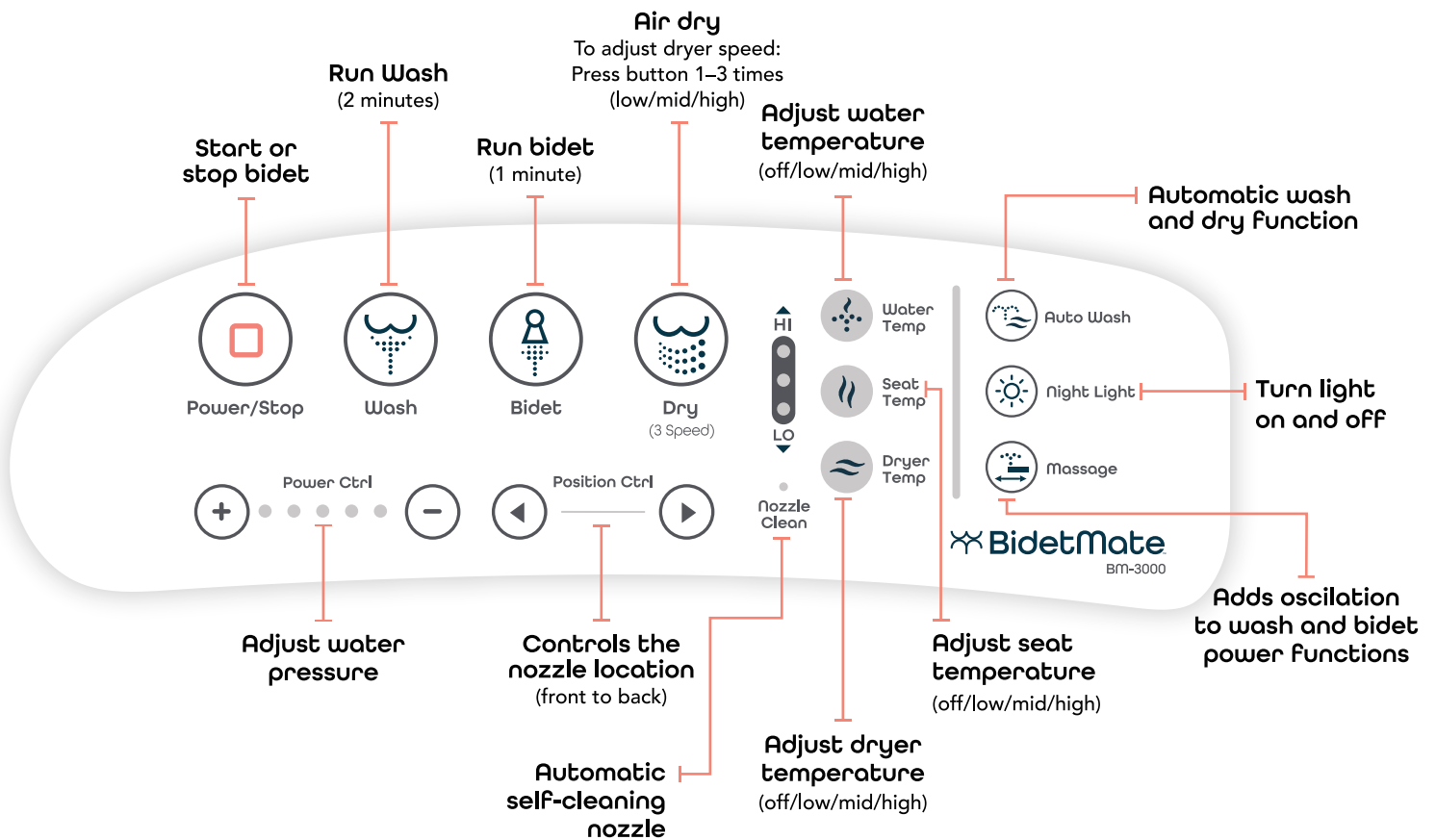

WARNINGS AND SAFETY

PLEASE READ THOROUGHLY

First of all, thank you for purchasing our product. To ensure proper and safe use of this product, carefully read this section prior to any usage. Afterwards, store this manual in a safe place for any needed future reference.

The hazards and warnings listed herein are important to our user's safety. Significant consequences may result from failure to heed warnings. The company will not be held liable for any injuries to the user and damages to the product due to improper usage and/or failure to heed safety warnings .

NOTATION

WARNING **Please pay close attention to avoid serious harm or accidents.**

ATTENTION **If not attentive, body or property damage may result.**



. . . . **Caution! Comply with guidelines.**



. . . . **Prohibited action!**



. . . . **Do not dismantle!**



. . . . **Keep away from direct contact with water or any liquid.**



. . . . **Do not touch this area!**



. . . . **Do not touch this area with wet hands!**



. . . . **Keep away from fire!**



. . . . **Operate as instructed.**







. . . . **Please unplug!**



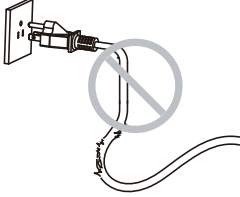

. . . . **Please confirm it is grounded!**

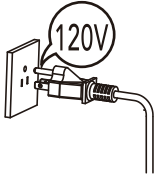
WARNINGS AND SAFETY

⚠ WARNING

<p>Make sure the power supply is grounded. ▶ Otherwise, electric shock may occur. ▶ Please consult qualified electrician or serviceman if the power supply is not grounded.</p>	<p>Do not place lit cigarettes or other ignited items on the product. ▶ Otherwise, fire may occur.</p>
<p>Do not touch or plug in the cord with wet hands. ▶ Otherwise, electric shock may occur.</p>	<p>Do not place lit cigarettes or other ignited items on the product. ▶ Otherwise, the device may be damaged or malfunction.</p>
<p>Do not connect power cord if the cord is damaged or broken. ▶ Otherwise, electric shock or fire may occur.</p> 	
<p>The product must be connected to standard voltage power source (AC120V±10%,Max Current 15A). ▶ Otherwise, electric shock or fire may occur.</p> 	<p>When the seat or lid is broken, please unplug the power and shut down the water supply. ▶ Otherwise, electric shock or fire may occur.</p>
<p>Do not forcefully pull, break, bend, strip, twist, or over squeeze the power cord and cable. ▶ Otherwise, electric shock or fire may occur.</p>	<p>Unplug and clean the dust on the power cord with a dry cloth regularly. ▶ Otherwise, fire may occur due to bad insulation.</p>
<p>The cord must be replaced by authorized personnel ▶ Otherwise, electric shock or fire may occur.</p>	<p>Individuals who are handicapped (physically, mentally, or emotionally) must be accompanied during use. ▶ Otherwise, long-term use may cause low-grade burns.</p>
<p>Please avoid installing the product while bathroom is wet. Do not splash water on the product. ▶ Otherwise, electric shock, fire, damage may occur.</p> 	<p>Children should not play with this product. ▶ Otherwise, injury may occur.</p>
	<p>Do not dismantle this product to repair or remodel. Only Authorized personnel such as a qualified electrician should service the product. ▶ Otherwise, malfunctions may cause electric shock, fire, or injury.</p>
	<p>Do not urinate on the product. ▶ Otherwise, electric shock may occur.</p>
	<p>Do not use polluted water supply. ▶ Otherwise, the water may damage the device or harm the user.</p>

WARNINGS AND SAFETY

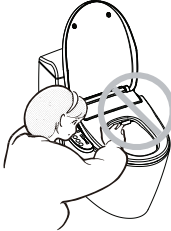
⚠ ATTENTION	
<p>If using any chemical toilet bowl cleaner, be sure to wipe up any spills that splash onto the plastic areas of the product. Do not use any acidic chemical detergent. Only neutral detergents are permitted.</p> <p>▶ Otherwise, the plastic may break and cause body damage, electric shock, or fire.</p> <div style="text-align: center;">  </div>	<p>Do not stand, sit, or lean forcefully on the lid of the bidet toilet seat. Do not open or close the lid/seat ring forcefully to avoid damage.</p> <div style="text-align: center;">  </div>
<p>Please do not let water or detergent wet the Bidet toilet seat or power plug.</p> <p>▶ Otherwise, there may be a risk of electric shock or fire.</p>	<p>Do not block the dryer door with hands or other objects. Do not cover the door during use.</p> <div style="text-align: center;">  </div>

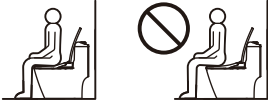
⚠ WARNING	
<p>Do not use warm or heated temperature settings for extended periods of time.</p>	<p>Do not expose to direct sunlight or heating device.</p>
<p>Please make sure the user is fully seated (see image below). Otherwise, the cleaning or drying function will stop.</p> <div style="text-align: center;">  </div>	<p>Do not use a timer power source or external switch to turn the device on/off. The thermal cutoff device may cause danger.</p>
<p>Do not urinate on the nozzle.</p> <p>▶ Otherwise, the nozzle may become obstructed.</p>	<p>Please turn off the water supply before replacing the filter. Firmly attach the filter before opening the water supply.</p> <p>▶ Otherwise, leakage may occur.</p>
<p>Please use provided accessories to install the device. Do not use old parts.</p> <p>▶ Otherwise, leakage may occur.</p>	<p>Please unplug and close water sources to the device when away for extended periods of time.</p> <p>▶ Otherwise, leakage or fire may occur.</p>
<p>During power failure, unplug the device and close the water supply valve to prevent leaking.</p>	<p>In very low temperatures, the water within the device may freeze after long periods of disuse. To avoid damage, please warm the unit to melt the ice.</p>

INSTALLATION

TOOLS NEEDED

Adjustable Wrench (1.02in+ width) OR Open End Wrench (0.91-1.02in)



>1.02in

OR



Phillips ⊕ Screw Driver

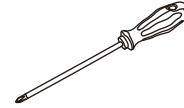

PARTS INCLUDED

Smart Bidet (1 set)

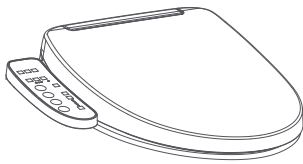

Catch Plate (1 pc)

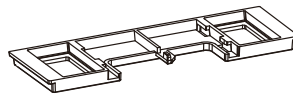

Screw components (2 sets)

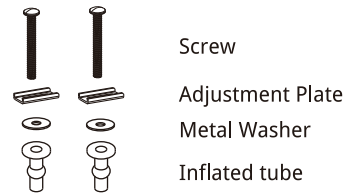

T-valve (1 pc)

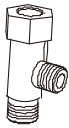

Hose (1 pc)

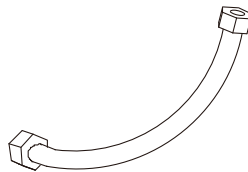

Owner's Manual (1 pc)

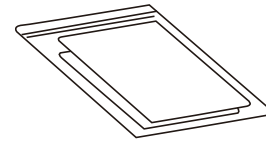

Fixed Card (1 pc)

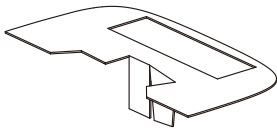

After opening the package, please confirm that you have received all parts listed above. If you are missing any parts, please contact us.

BEFORE YOU INSTALL

ENSURE THE FOLLOWING BEFORE BEGINNING INSTALL

IMPORTANT! Before installing the product, please make sure that you meet all the requirements listed below.

Power Requirements

- The power rating should be within the required range (AC 120V \pm 10%, Max current 10A above)
- The power outlet should be close enough to reach the power cord (47.24in) but far from where water can hit it.
- This product must be grounded.
 - The wiring should be installed by a professionally licensed electrician.
 - Please do not plug in the product before installation is complete to prevent malfunction.

Water Requirements

- The minimum dynamic water pressure required is 0.08MPa.
- The maximum static water pressure required is 0.8MPa.
- Water pressure below the min and max range above will affect the performance of the product.

Sizing Requirements

- Please measure your toilet to make sure that there is enough space for the bidet (20.43in long).

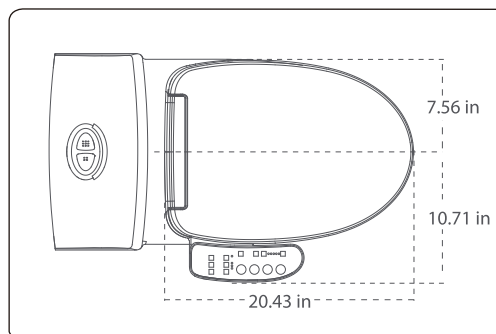

- The distance between the 2 mounting holes must be within 4.72-6.89 in.
- The distance from the filter to the bidet inlet should be 21.65 in or less.
- The distance between the mounting holes and the edge of the toilet bowl must be within 17.99-19.72 in.

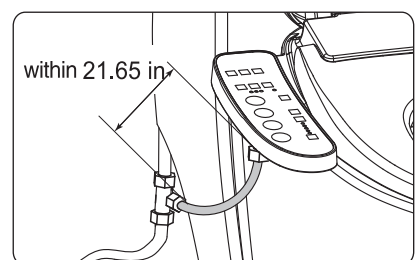
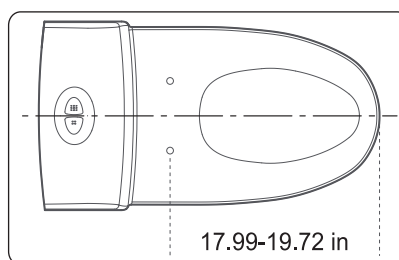
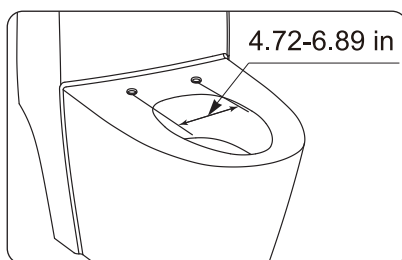

※The product has no Ground Fault Circuit Interrupter, It should be installed in the line with Ground Fault Circuit Interrupter, Otherwise, the accidental failure of this product may result in the loss of life or property.

INSTALLATION

INSTALL YOUR UNIT BY FOLLOWING ALL STEPS

1 Install the electronic bidet seat

1. Remove the existing toilet seat.
 - (a) Remove the toilet seat mounting bolts.
 - (b) Remove the existing toilet seat from the toilet.

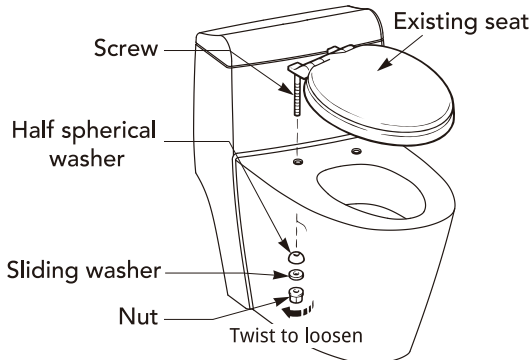

2. Insert the rubber anchors into the mounting holes on the toilet bowl.

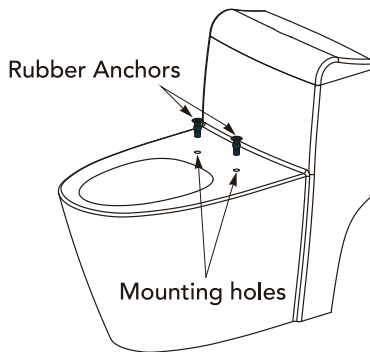

3. Place the installation guide on the toilet bowl where the mounting holes are. Make sure that the wash/dry gates are close to the rim and pointed down.

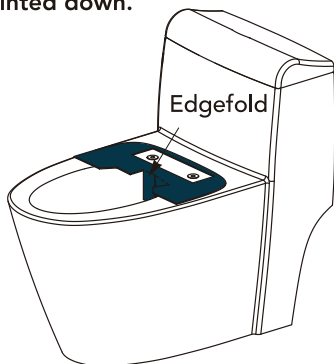

4. Install the Catch Plate

- (a) Place the Catch Plate in the rectangular space of the Fixed Card. The arrow should point to the back of the toilet.
- (b) Place the metal washers on the expansion nuts, then place the adjustment plates in the catch plate. Insert screws through adjustment plates and metal washers. Tighten screws and nuts.

The ↑ sign should point towards the back of the toilet
↑ Sign on the catch plate

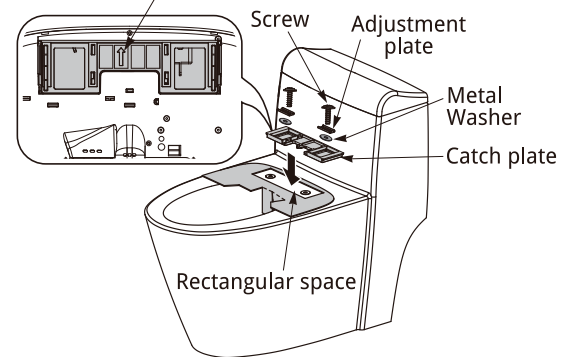

5. Install the electronic toilet seat

- (a) Remove installation guide.
- (b) Press the push rod button and slide the seat into the Catch Plate.
- (c) Adjust the position of the seat and loosen the screws to adjust position, if necessary.

Slide seat towards
back of toilet

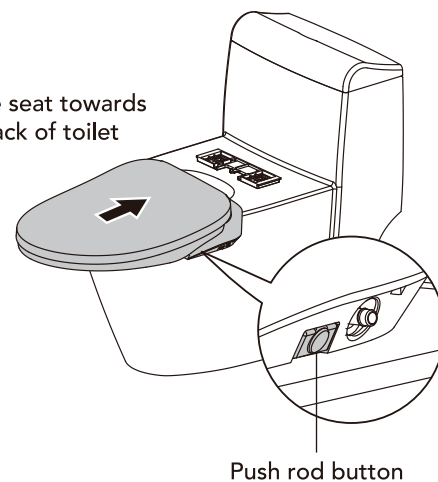

INSTALLATION

INSTALLATION STEPS (CONT.)

2 Install the filter and hoses

1. Connect T-valve to tank.

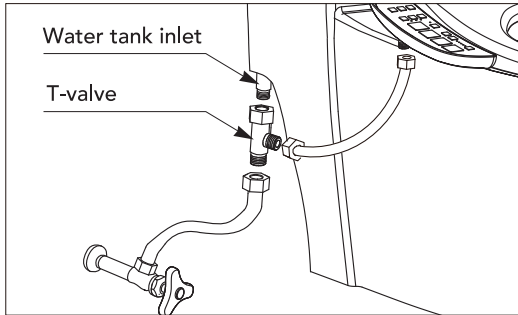

2. Connect the hose to T-valve.

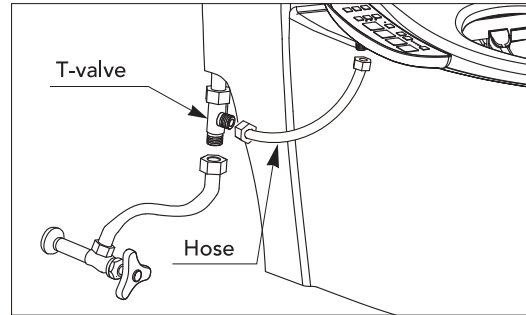

3. Existing water pipe connect T-valve.

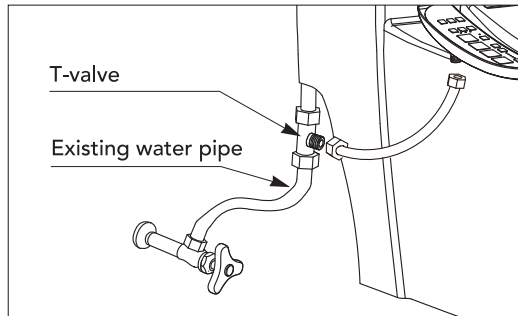

4. Connect the hose to bidet and then use collar to fix.

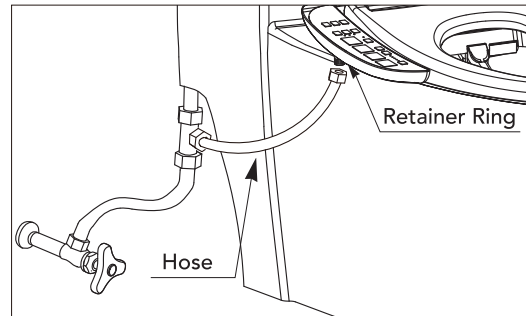

3 Turn on the water

1. Turn the water back on by turning the knob on the supply angle valve counter-clockwise until the valve is fully open.
2. Check all connections carefully and make sure that there is no water leakage from any connection.
 - (a) If there is leaking from a connection, retighten the connection.

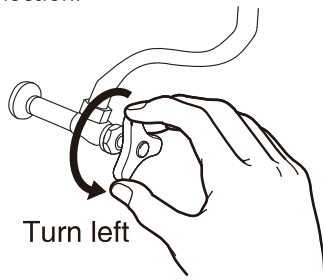

4 Link the power

1. Insert the bidet plug into the outlet (120V).

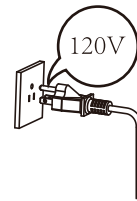

2. Confirm the power connection.

- (a) Press and hold down the power button for 0.5 seconds to turn on the bidet seat.
- (b) The spray strength indicator on the control panel should light up when the bidet turns on.



FUNCTION EXPLANATIONS

BASIC FUNCTIONS

- Functions will only work when user is seated on the bidet seat.
- Dryer will automatically stop after using for 4 minutes.

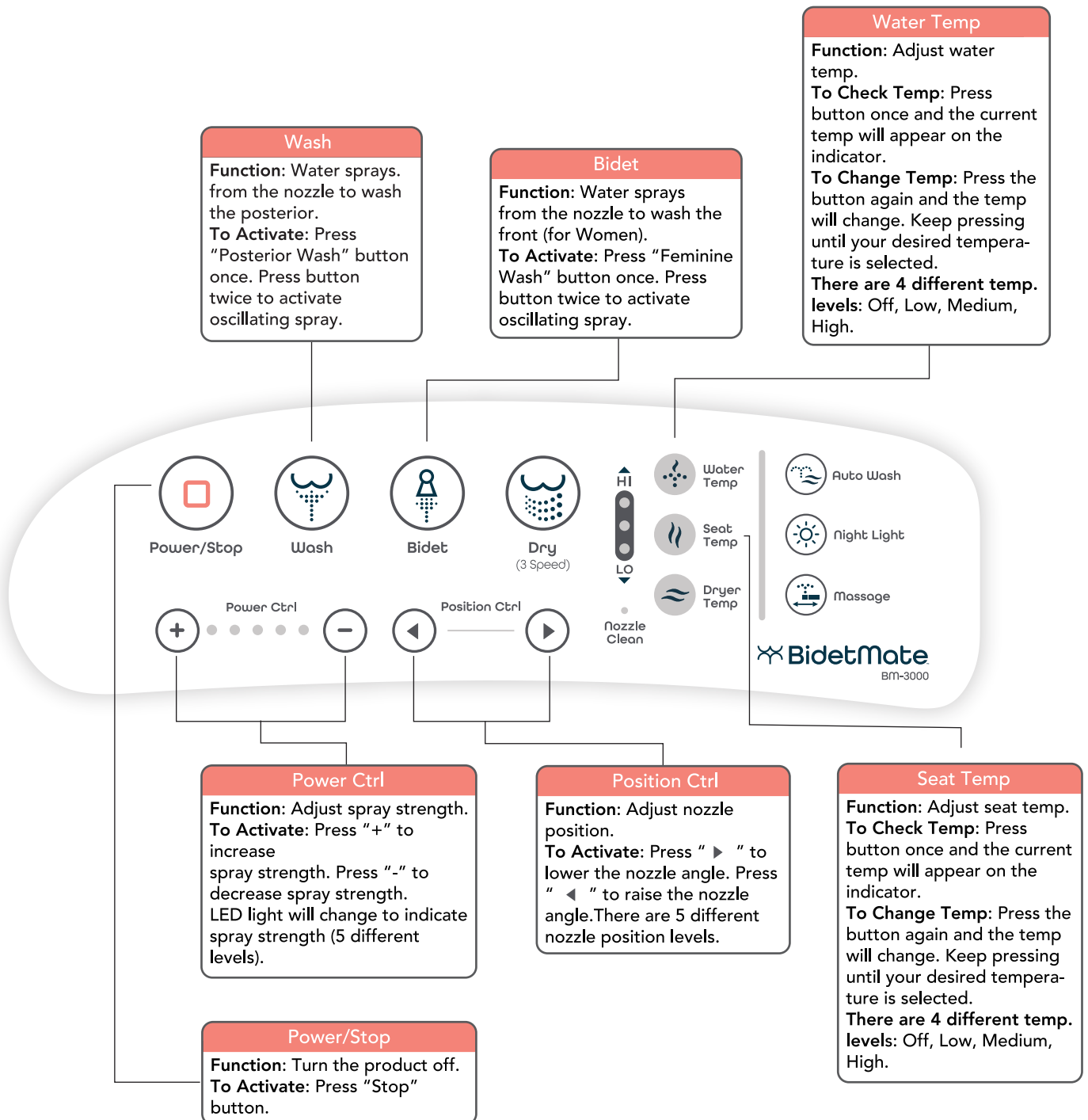

FUNCTION EXPLANATIONS

DRYER

Dryer will automatically stop after using for 4 minutes.

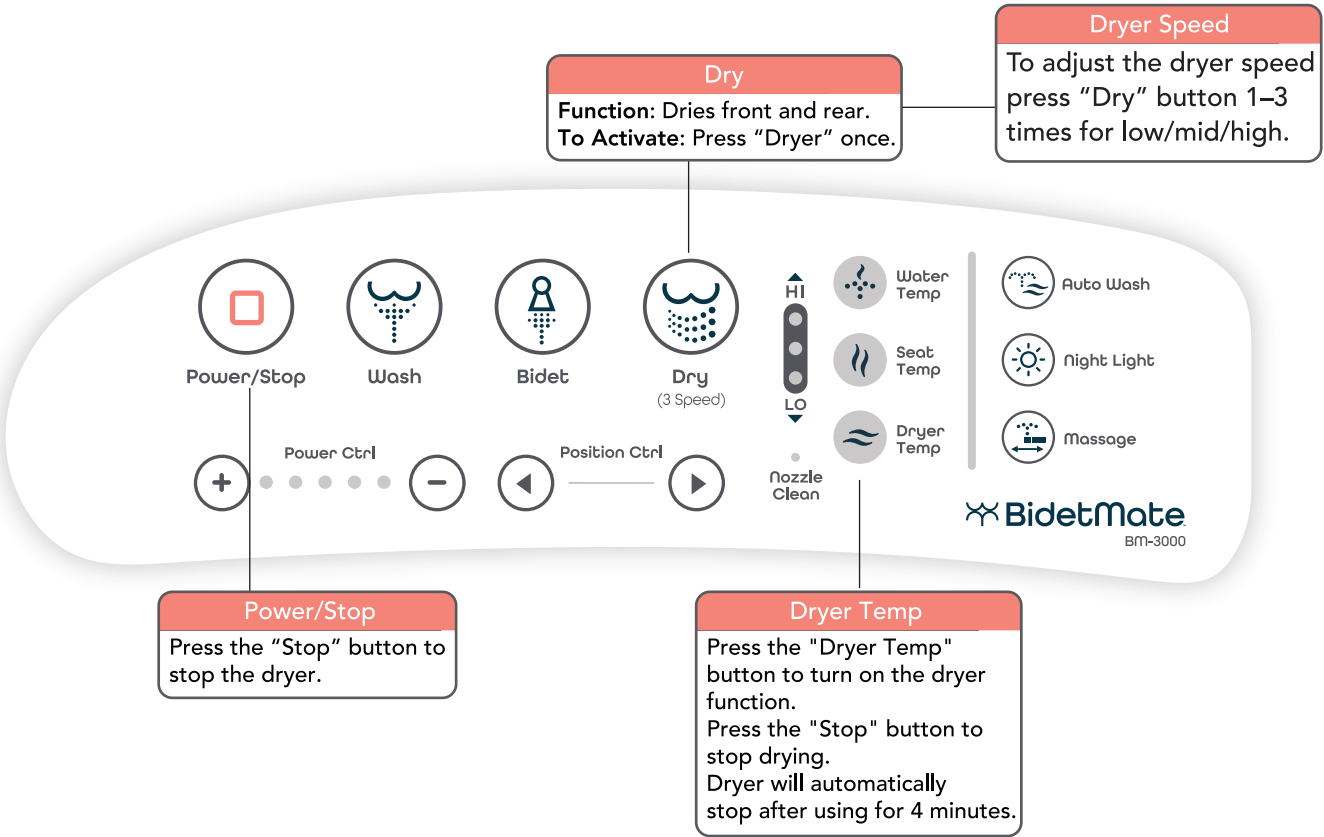

UV STERILIZATION

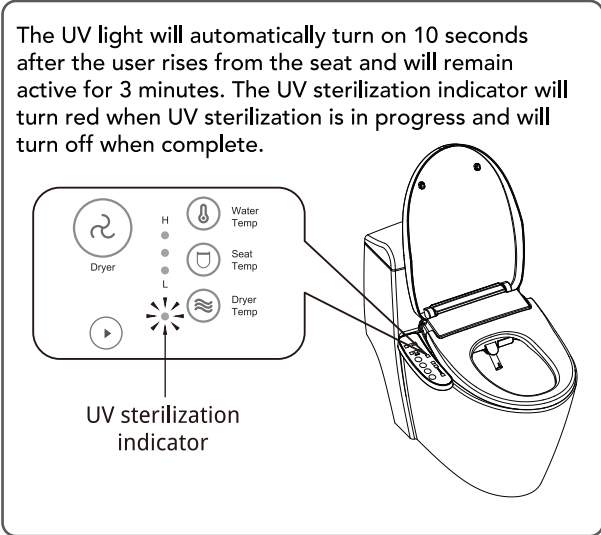

FUNCTION EXPLANATIONS

OTHER FUNCTIONS

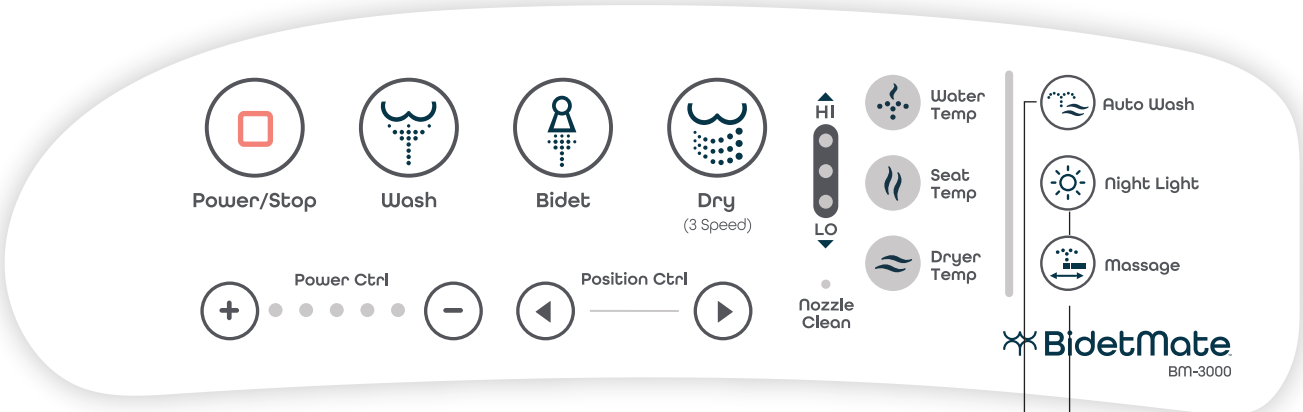

Auto Wash

Function: Auto clean and dry. Function in progress, short press "Automatic Cleaning" again to stop / start back and forth. Automatic functions like Posterior wash and Drying are particularly suited for kids and the elderly.

Night Light

Function: Night light.
To Activate: Press button to turn on/off the night light.

Massage

Function: Alternate water temp of spray between cold water to hot water in turns.
To Activate: While in wash mode, press the "Massage" button once.

RESTORING FACTORY SETTINGS

To restore the product to the original factory settings, pull the plug from the wall, wait 1 minute, then reconnect the plug. The Water Temp, Seat Temp, Dryer Temp, Spray Strength, and Nozzle Position will restore to the original Middle level settings.

MAINTENANCE

HOW TO PROPERLY CARE FOR YOUR BIDET

- Before maintenance, please unplug the power source and shut off the water supply.
- Regular maintenance is required to ensure that the product operates at optimum efficiency.

Maintenance of Lid, Seat, and Plastic Parts

- Wipe the lid, seat, and plastic parts with a wet soft cloth (water).
- Please wipe with water frequently or the product will become hard to clean later if the dirt and debris is not removed on time. Wiping with water can also help prevent static electricity from generating around the product, which can cause the product to accumulate dust and become dirty.
- For a deeper clean, the bidet can be removed from the toilet to access the surface beneath. To remove the bidet, press the catch plate button located on the right side of the bidet, then lift the bidet slightly to extract. (do not remove the bidet forcefully).

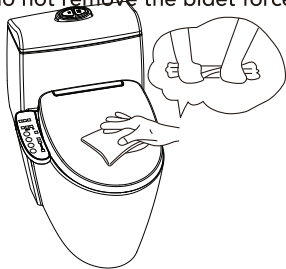

Maintenance of the Nozzle

- Press "Water Temp" for 3 seconds without occupying the seat, the nozzle will extend and can be cleaned with a soft brush.
- Do not try to pull the nozzle out with force, or the nozzle may break.
- When the nozzle is clogged, it is recommended to replace it with a new one.

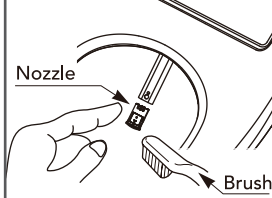

Maintenance of Steel Mesh Filter

- For your health, as well as optimal performance of the bidet, please clean or replace the filter regularly.
- If you notice that the water pressure is becoming weaker, please wash or replace the filter.
- Please make sure to turn off the water supply completely before removing the filter. Attach the new filter securely to avoid leakage.
- Turn the coin counterclockwise to open the filter and use a brush to clean.

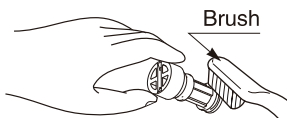

Recommended: Every 1-2 months

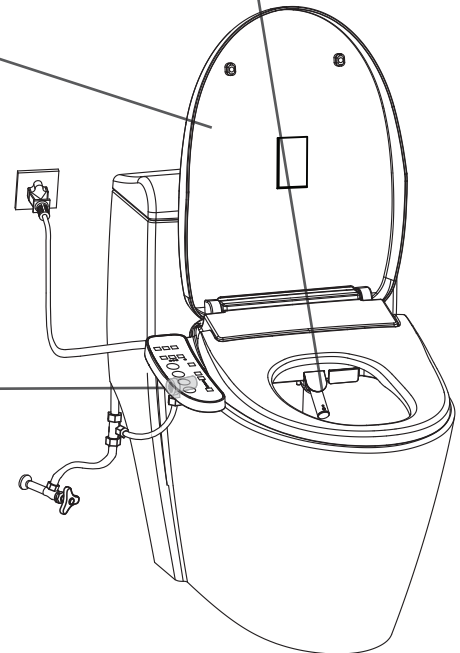

⚠ ATTENTION

Do not spray water or detergent on the bidet, remote control, or power cord. Otherwise, electric shock or fire may occur.

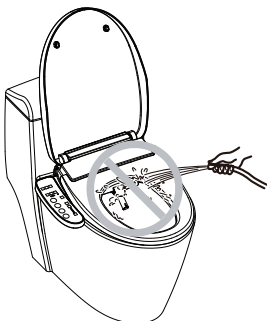

⚠ WARNING

While cleaning the plastic parts, do not use strong, acidic chemical cleaners (concentrated sulfuric acid, nitric acid, glacial acetic acid, carbon tetrachloride, chloroform, acetone, butyl ketone, benzene, toluene, phenol, cresol, methyl ether, methyl formamide, soybean oil, vinegar, 40% nitric acid, hydrochloric acid, 95% alcohol liquor, gasoline, kerosene, brake oil, etc.). Please only use neutral cleaners. Otherwise, the plastic may break, and cause body damage, electric shock, or fire.



TROUBLESHOOTING

EXPERIENCING AN ISSUE WITH YOUR BIDET?

If the user should run into any issues, please consult the troubleshooting guide below. If problem persists, please contact a professional.

Power button

Problem	Possible Causes	Possible Solutions
Toilet is not working	Blackout or loose socket	Check that power cord is plugged in
	Power off (Power indication light not on)	Press power button until indication light turns on
	Electric leakage	Unplug power cord, re-connect, then power on. If it is still not working, please unplug again and contact us

Wash Functions

Problem	Possible Causes	Possible Solutions
Water does not spray	No water in the supply	Wait for the water to restore to its normal levels
	Water supply is turned off	Turn water supply valve to turn on water
	Filter is stuck	Clean or replace filter
	Water hose is twisted	Stretch hose until it becomes untwisted
Water pressure is weak	Water level is set to LOW	Turn up water level to higher setting
	Filter is stuck	Clean or replace filter
Spray is off-center	Operational failure	Unplug device and re-plug in after 1 min
Water is not warm	Water temp. is set to LOW	Turn up water temp. level to higher setting
Water is leaking	Parts are loose or damaged	Contact us
Wash function does not activate	Check if the seat is lifted or sitting on something	Fix seat so it is flush on the bowl and remove any objects underneath
	Body sensor is broken	Contact us

TROUBLESHOOTING

Dryer

Problem	Possible Causes	Possible Solutions
Dryer is not warm	Dryer temp. is set to OFF	Turn up dryer temp. to higher setting
	Dryer is broken	Contact us
Dryer stops during use	Dryer will stop every 4 mins	Enable dryer again

Heated Seat

Problem	Possible Causes	Possible Solutions
Seat temp. not warm	Seat temp. is set to OFF	Turn up seat temp. to higher setting
	Power-saving mode on	Turn off power-saving mode

Other

Problem	Possible Causes	Possible Solutions
Lid or seat closes fast	Damping is broken	Contact us
Functions work in turns nonstop	QA testing model activated	Unplug device and re-plug in after 1 min

SPECIFICATIONS

BM-3000P

Model Number		F1N525
Rated Voltage		AC 120V, 60Hz
Rated Power		1050W
Environmental Temp		41°F~104°F
Water Inlet Environment		41°F~104°F
The range of water inlet pressure	Minimum necessary water pressure	0.08MPa, and also make sure the water flow is above 2.3L/10s
	Maximum water pressure	0.8MPa (in a static condition)
Flushing	Way for heating	Transient heating
	Temp pf warm water	Off/about 86°F~104°F
The length of power line		47.2in
The size of product		20.43" x 18.27" x 4.84"