

# Assembly Instructions

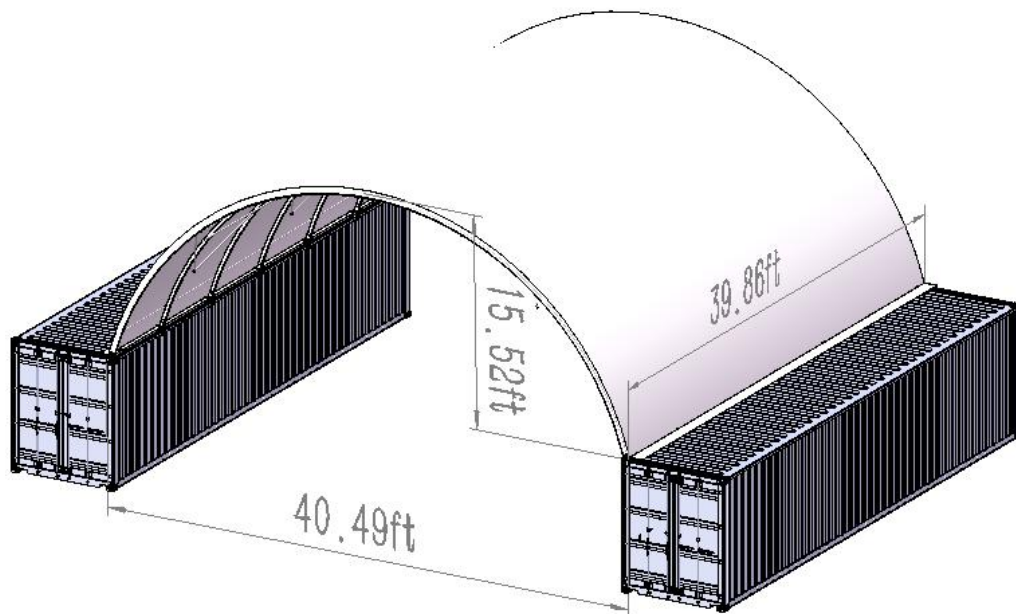

Model:KC4015

Recommended Foundation: W12.3xD12.1m

CAUTION:SOME PARTS HAVE SHARP EDGES.CARE MUST BE TAKEN WHEN HANDLING THE VARIOUS PIECES TO AVOID AMISHAP.FOR SAFETY SAKE,PLEASE READ SAFETY INFORMATION PROVIDED IN THIS MANUAL BEFORE BEGINNING CONSTRUCTION.WEAR GLOVES WHEN HANDLING METAL PARTS.

## **AFTER THE INSTALLATION:**

Walk around and inspect the building periodically to make sure all components are still firmly secured and the whole building is well supported. Check all bolts and nuts as well as all connection points to make sure they are all in good position. Check the base plates, adjust the ropes and tie downs if required and clean the cover regularly.

Snow accumulating on the fabric cover must be removed as soon as possible, If snow becomes solid ice on the cover, it will increase the weight on the roof and collapses the building or reduce the life span eventually.

Keep the building on a dry ground most of the time. Do not keep the fabric dirt skirt under water all the time, otherwise the fabric will deteriorate.

We strongly recommend you remove any snow from the roof immediately. Do not leave any snow load on the roof overnight. Keep 3 feet of clearance on all sides at all times. Do not allow snow to accumulate and pile up on the sides of the building. Otherwise the push from the sides toward inside will make the building collapsed at some Point.

## **MAIN SPECIFICATIONS :**

- . Assembly size : W12.3 x D12.1 x H4.7 (m) / 40 x40 x 6.9 (ft)
- . Outside width : 12.3 m / 40ft, inside width : 12.1 m /40ft, length : 4.7 m / 15.4ft
- . Ridge peak height : 4.7 m / 15.4 ft

## **PRIOR TO ASSEMBLY**

Please go through the whole instruction manual completely. It is very important to follow your local safety regulations and industry standards during installation.

Regulations may include but are not limited to :

- Safety helmets, protective eyewear, and clothing
- Safety harnesses for all elevated workers
- Proper ladder, cage, and safety operation















Check all components and parts before installation. All parts are marked with a part number, please refer to the parts list to ensure you have all parts.















Choose a day with low or no wind to install, it is hard to assemble with heavy wind. Do not make any alterations to the structure. Do not hang any weight on the frame during installation, including parts. We are not responsible for any damages or injuries caused by inappropriate installation, unauthorized modifications or extreme weather.

This building is not intended for human occupancy.





Check the parts list below to make sure all parts are received prior to assembly.

# PARTS LIST

Item no.	Reference Image	Qty.
1		1
2		4
3		1
4		1
5		4
6		1
7		10
8		4
9		4
10		14
11		14
12		14
13		14
14		14
15		7

Item no.	Reference Image	Qty.
16		20
17		20
18		30
19		12
19A		2
20		20
21		1
22		1
23		100
24		14
25		14
26		24
27		4
28		40
29		28

# PARTS LIST

30		14
31		112
32		55
33		40

# FRAME

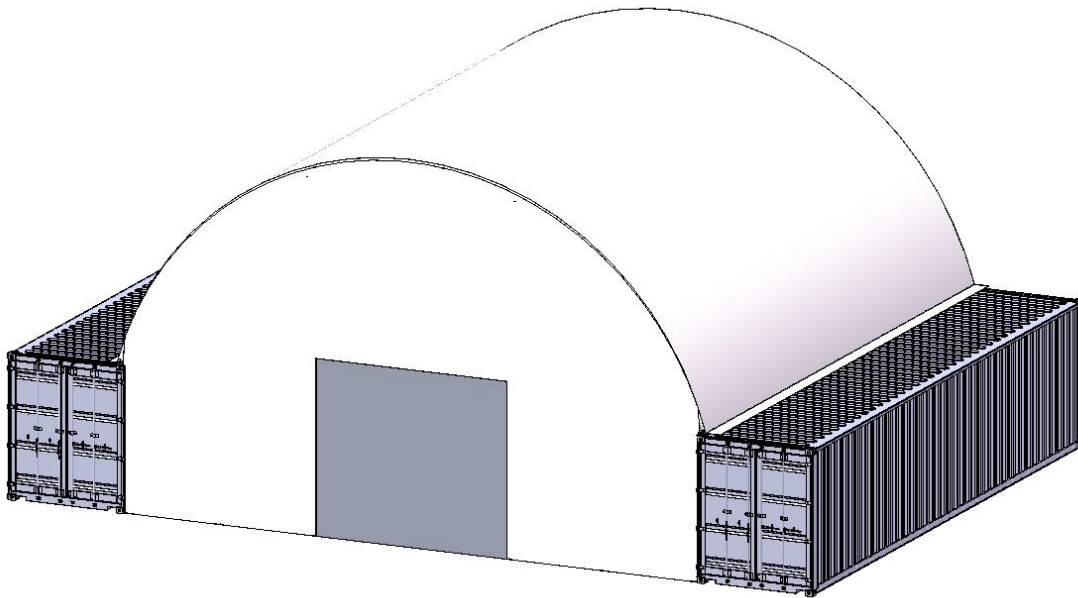

**Please note: The curtain part is an optional accessory and needs to be purchased separately.**

# Step 1

1x1 2x4 3x4 4x1 5x4 6x1 7x10 8x4 9x4 26x24 27x4 28x40

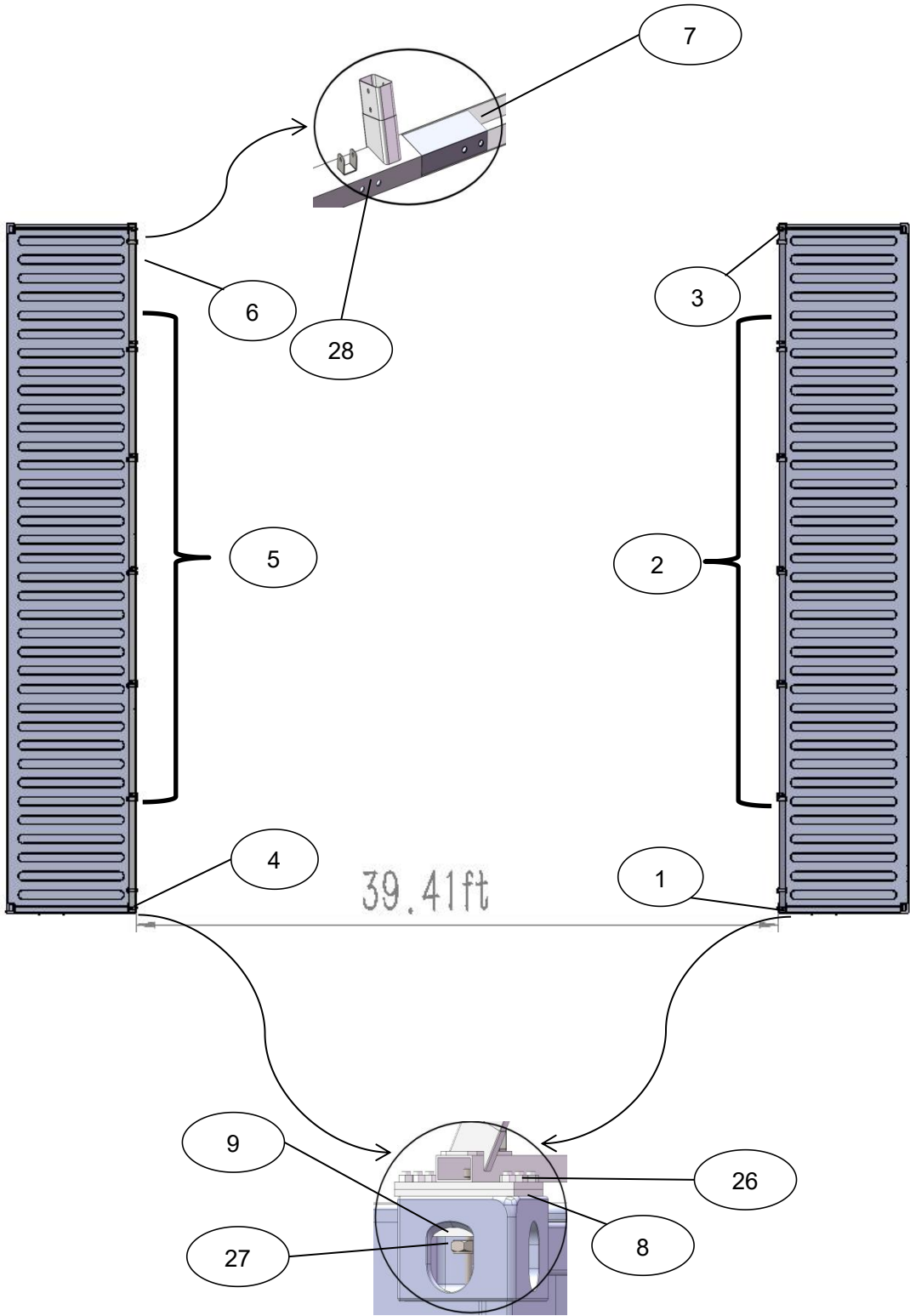

Step 2

10x14 11x14 29x28 30x14

10 and 11 can be placed at the desired positions depending on the actual installation situation.

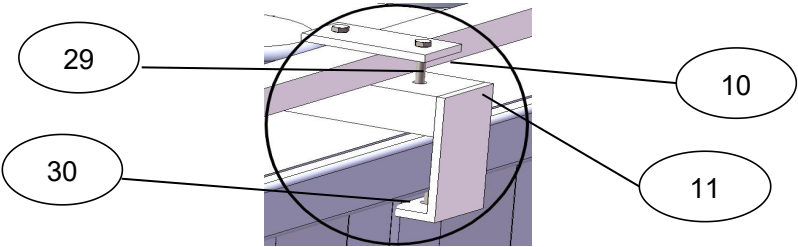

# Step 3

12x14 13x12 14x12 15x7 31x112

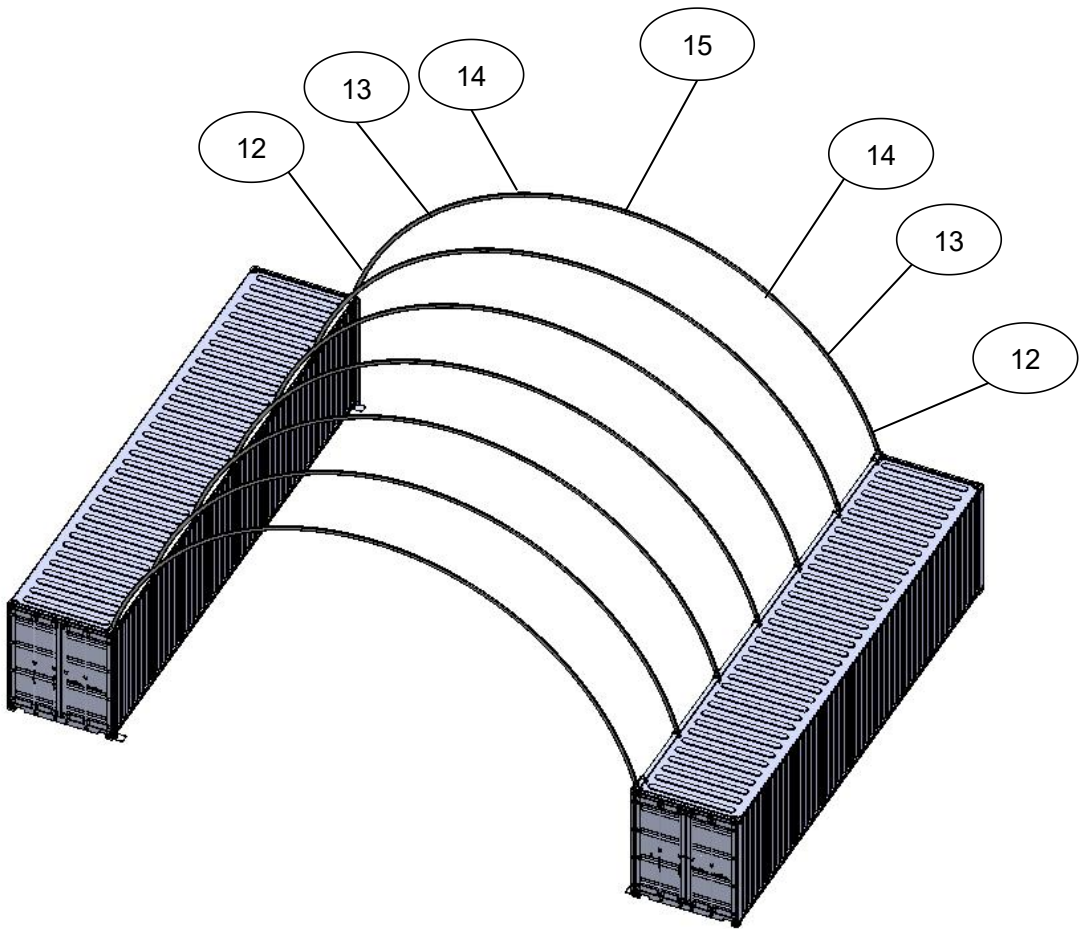

# Step 4

16x20 17x20 32x20 33x40

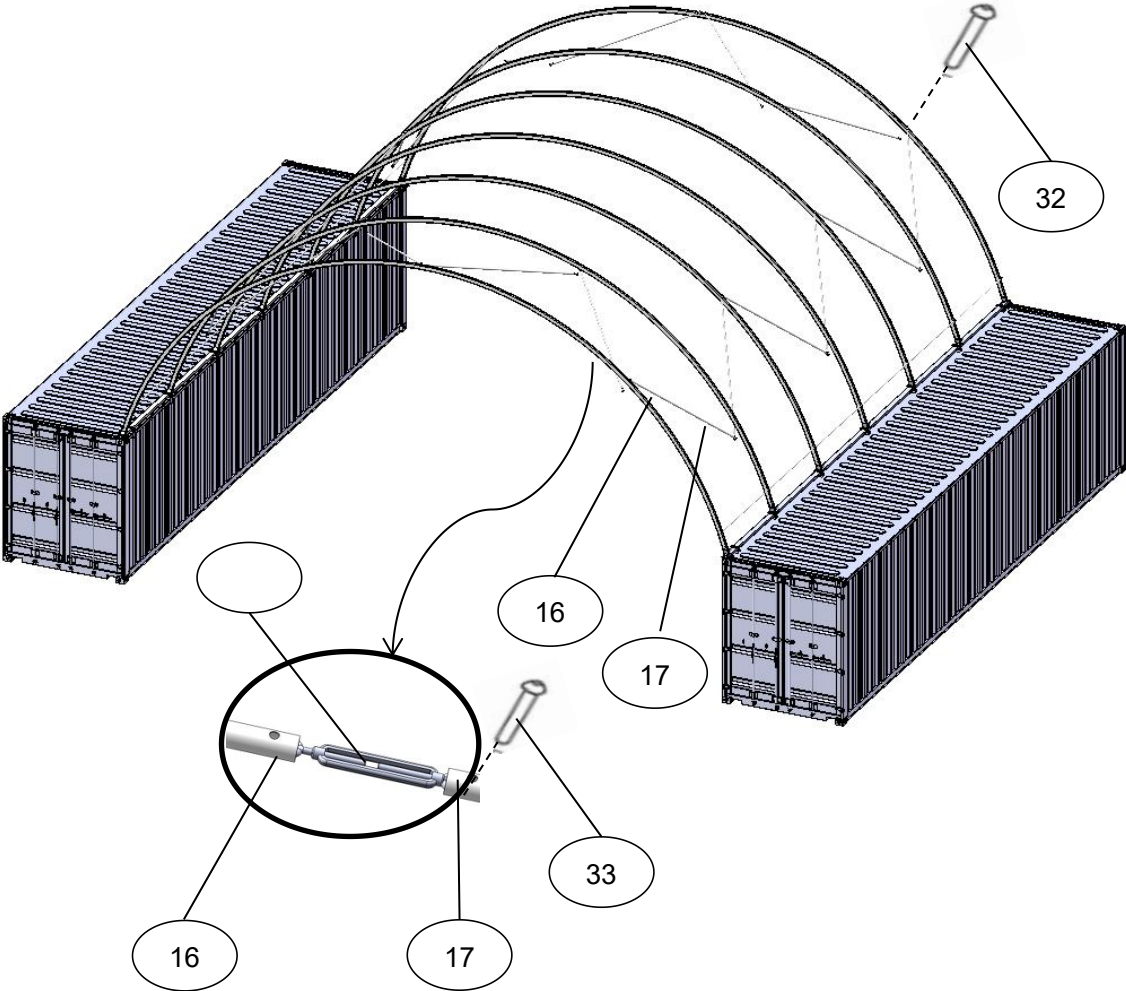

# Step 5

18x30 32x35

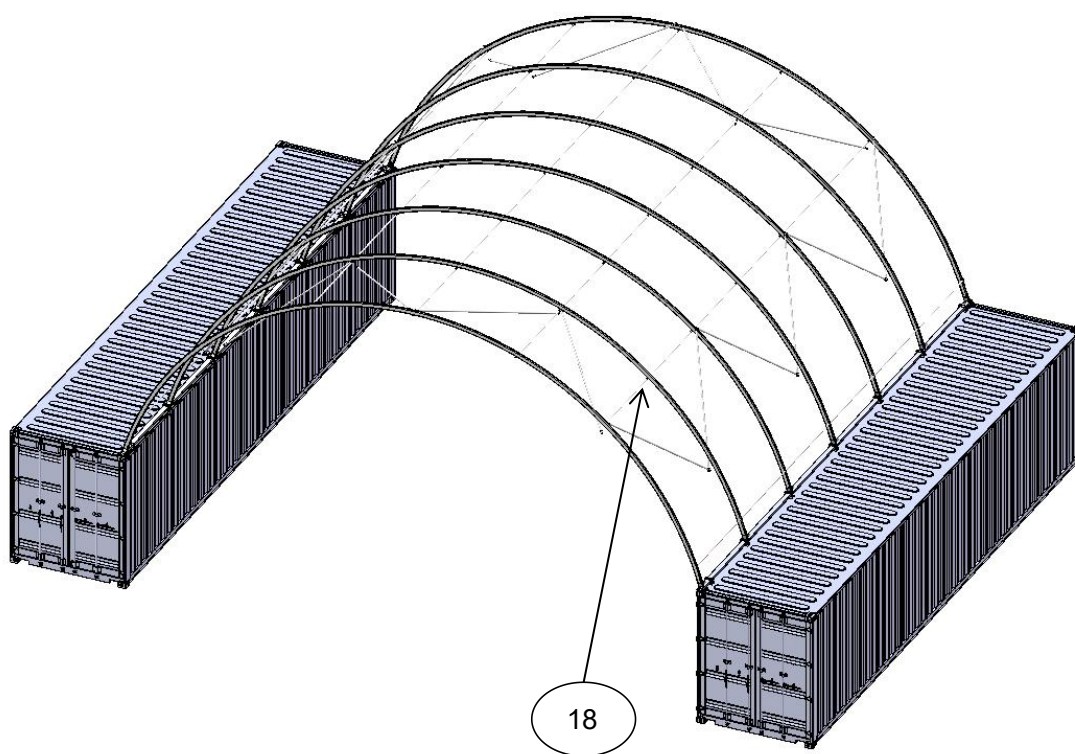

# Step 6

19x12 19Ax2 21x1 22x1 23x100 24x14 25x14

