

Thank you for your purchase!

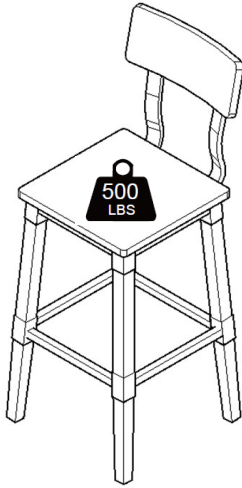

# Wooden Dining Barstool

## ASSEMBLY INSTRUCTIONS

### Before You Begin:

Please identify all component parts and hardware pieces required before you begin. Carefully remove all of the components from the packaging and set aside for assembly. Assemble on a soft surface to prevent scratching during assembly.

### Caution:

Tighten all components securely before use. Failure to do so may result in personal injury. DO NOT use any sharp objects to open plastic wrapped components as damage to product or components may result.

### Warning:

**CHOKING HAZARD** - Small Parts. Adult Assembly Required.

### **DO NOT ALLOW CHILDREN TO CLIMB ON FURNITURE**

Serious or fatal injuries can occur from furniture tipping over. You must install Tipping Restraint Hardware (where included) to help prevent the unit from tipping and causing accidental injury, instability, death or damage. The tipping restraint is intended only as a safety measure, it is not a substitute for proper adult supervision.

To help prevent furniture from tipping over it must be permanently attached to the wall. Anti-Tip Safety Wall Straps suitable for the unit weight and wall materials (if not included) should be purchased and installed.



# Congratulations!

You just purchased a piece of happiness. , we believe you can transform your spaces into the most inspired places with furnishings that are the perfect combination of form, function and style. As original innovators of online furniture retail, we offer the best selection of popular, contemporary styles at cool, comfortable prices. And, with decades of proven shipping and packaging expertise, our Extended Quality Checklist ensures a rewarding, hassle-free experience time and time again. It's just what you need to bring your vision to life.

**Thank you & Enjoy!!**



**LIKE IT!**

*Share it on social  
& Tell a friend!  
#Spaces2Places*



**LOVE IT!**

*Write an online  
product review  
where purchased*



**NOT SURE?**

*Let us help!  
Contact our  
customer support.*



We pride ourselves on providing an excellent customer experience starting right here with your package and instructions. Everything you need should be right where you need it, so you can get to enjoying your new item ASAP. But despite our best efforts, sometimes "slips happen." If you need any support, from replacement parts to recommendations, please reach out to our wonderful customer support team

## GROUP PRODUCT



Quality &  
Durability Tested



Packaged  
with Care



Shipped from  
our U.S. Facility

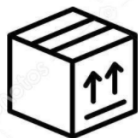

Designed  
for Easy  
Assembly



Ethically  
Sourced





**Read this manual before using this product. Failure to follow the instructions and safety precautions in this manual can result in serious injury or death. Keep this manual in a safe location for future reference.**

## PARTS

### Part List:

NO.	PARTS	
A	BAR Backrest	1PC
B	Seat Frame	1PC

### Hardware List:

NO.		HARDWARE		Q' TY
1.		Bolt	Dia1/4x1 1/4	2PCS
2.		Bolt	Dia1/4x1 3/8	2PCS
3.		Washer	Dia1/16x 5/8	4PCS
4.		Allen Wrench	Dia13/32	1PCS

## STEP 1

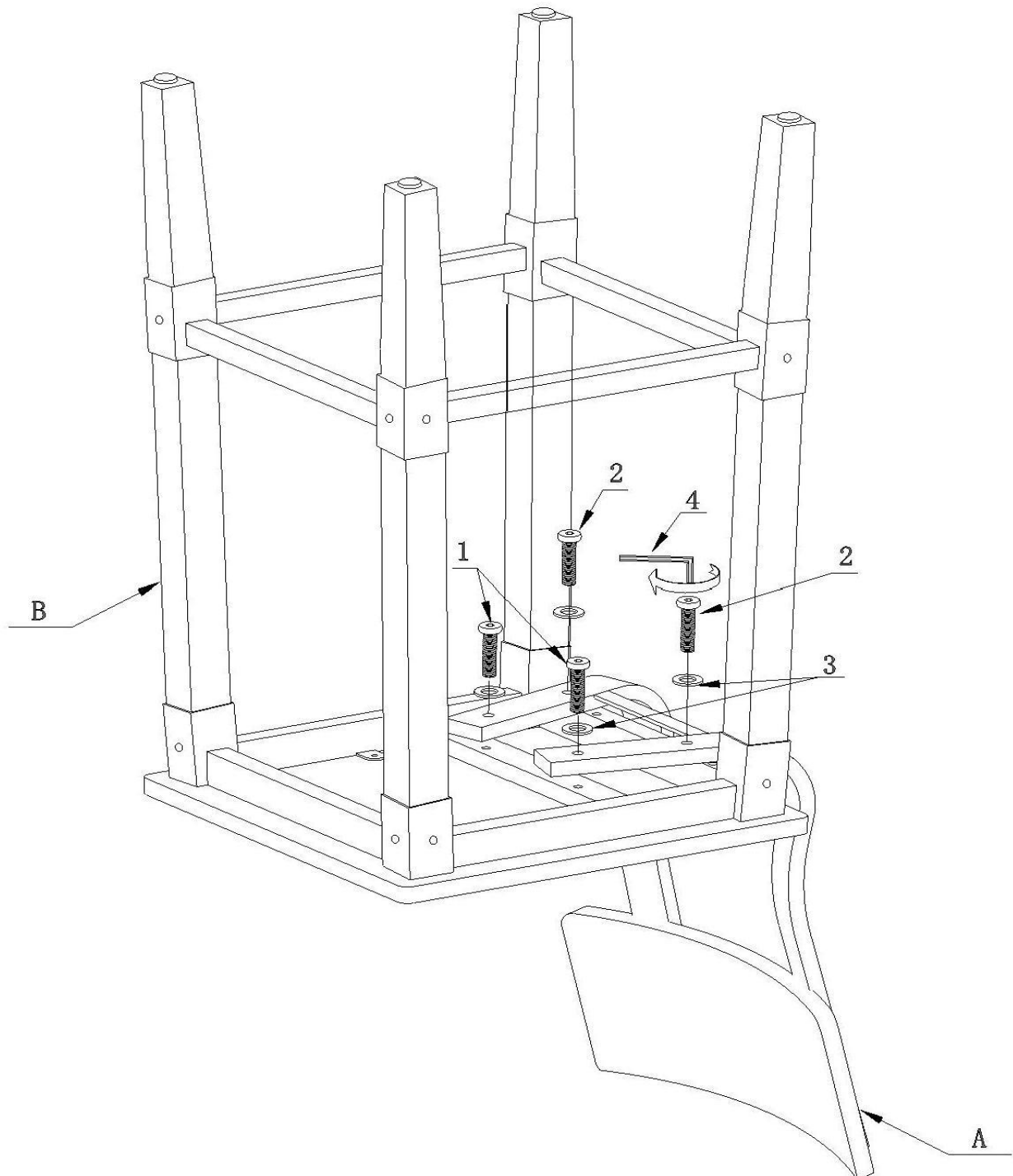

# Quality and Safety Guidelines

- Please follow the static and dynamic weight capacity limits provided on this item. If you are unsure of the weight capacities for this product.
- Please use this item on a stable, level surface only. All chair legs should contact the flooring surface when in use. Do not use this item if any instability is detected.
- This chair is not intended for reclined positions. To prevent accidental tipping, do not push backward or forward while seated.
- For maintenance instructions and replacement parts, please email us at mail to:
- This item is intended for sitting only, do not climb or stand on this item.
- This item is intended for indoor use only. Please store indoors in a dry location.

