

ASSEMBLY INSTRUCTION

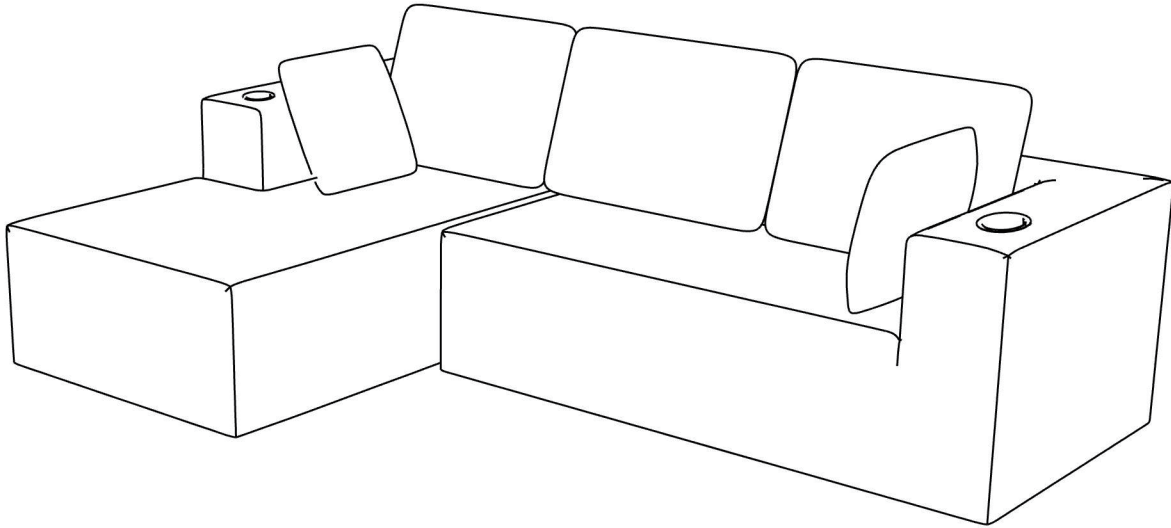

Your Satisfaction, Our Priority

We are committed to providing top-quality products and doing our utmost to ensure every customer is fully satisfied, offering replacement parts or services as needed.

TIPS

1. Due to differences of light effects, the actual color of the upholstery may vary slightly from what is shown in the pictures.
2. No Assembly Required. This sofa bed saves you from the common hassle of complicated furniture assembly.
3. Due to package compression for better shipment, the upholstery may have wrinkles upon arrival.
4. After unboxing, take all parts out and gently pat them to help the sponge rebound and regain its original fluffy appearance.
5. Safety Warning - Keep children away from plastic bags for safety.
6. If your item arrives damaged or defective, please do not return it directly to the store. Instead, contact us as soon as possible, and we will provide a prompt and satisfactory solution, including replacement parts or a refund.

 (24H/7DAYS): service@kmcglobe-us.com
 (only us) +1 213-816-4788(24H/7DAYS)

PACKING LIST

1.

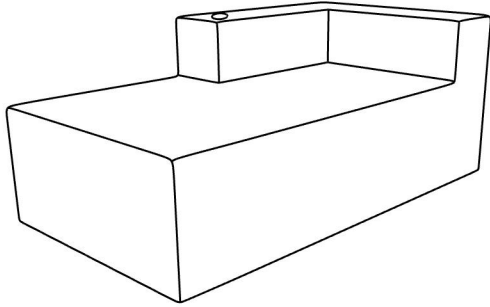

Chaise longue (1PC)

2.

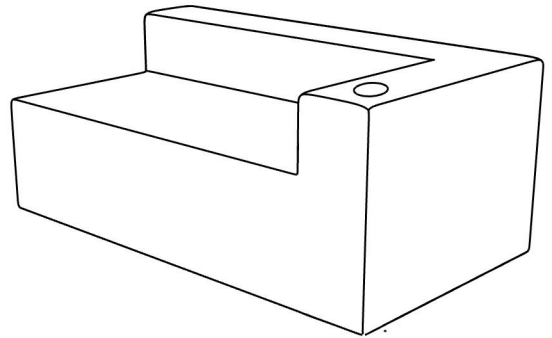

Double seat (1PC)

3.

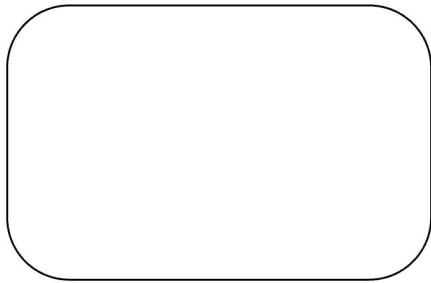

BACK CUSHION (3PC)

4.

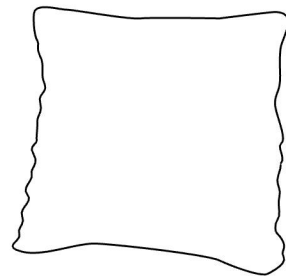

PILLOWS (2PCS)

5.

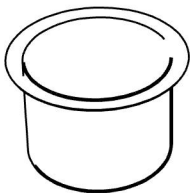

BACK CUSHION (2PC)

6.

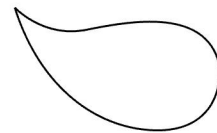

PLASTIC BOX OPENER (1PC)

ASSEMBLY INSTRUCTION

STEP1. Take all the parts out of the carton.

Use the included plastic box opener to cut open the first package layer.

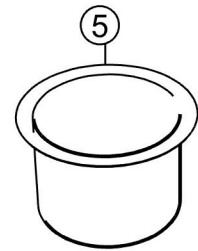
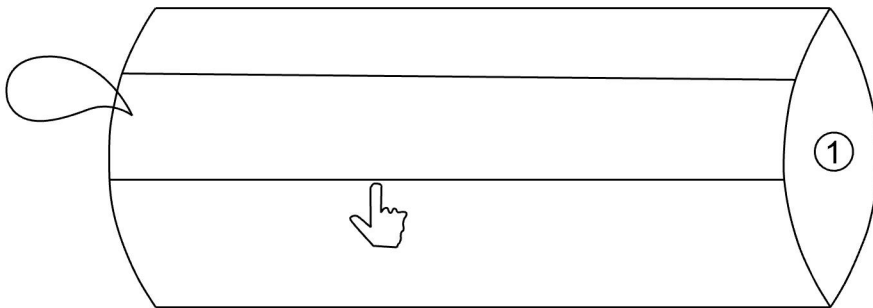
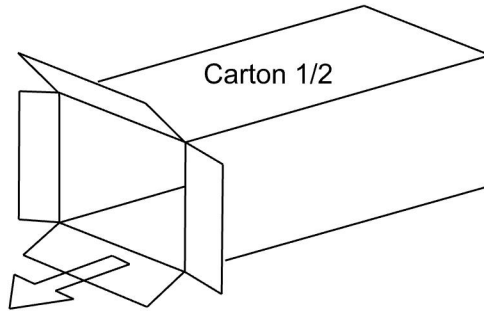
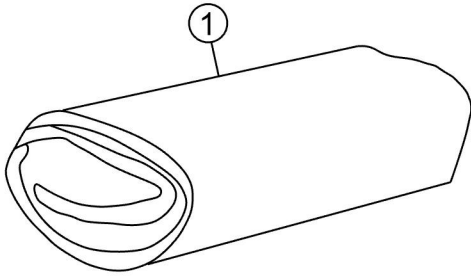

STEP2. Take all the parts out of the carton.

Use the included plastic box opener to cut open the first package layer.

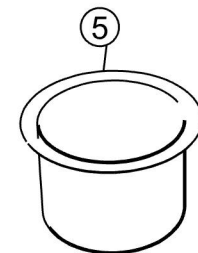
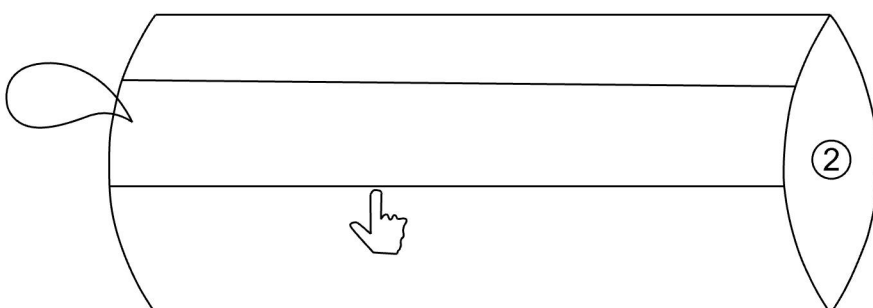
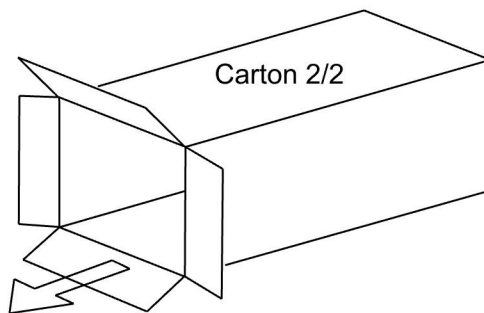
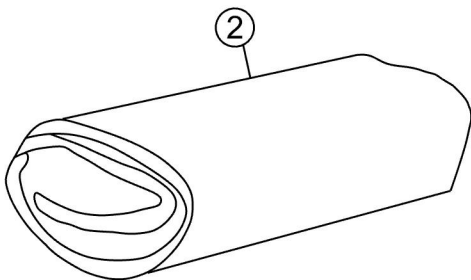

ASSEMBLY INSTRUCTION

STEP3. Use the box opener again to cut open the second package layer.

Attention: The sofa will be released from the vacuum state and begin to inflate.

Please ensure safety during this step to avoid injury from the expanding sofa.

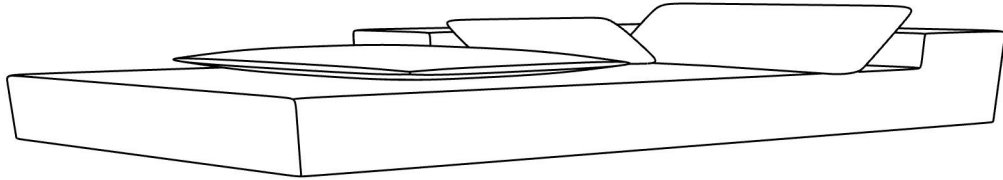

Tips:

1. After cutting open the first package layer and taking it off, you can lay the left packaged sofa flat on the floor.
2. Please carefully cut open the second package layer to avoid damaging the sofa upholstery.
3. After this step, the sofa will expand and restore to its original fluffy state after about 72 hours.

ASSEMBLY INSTRUCTION

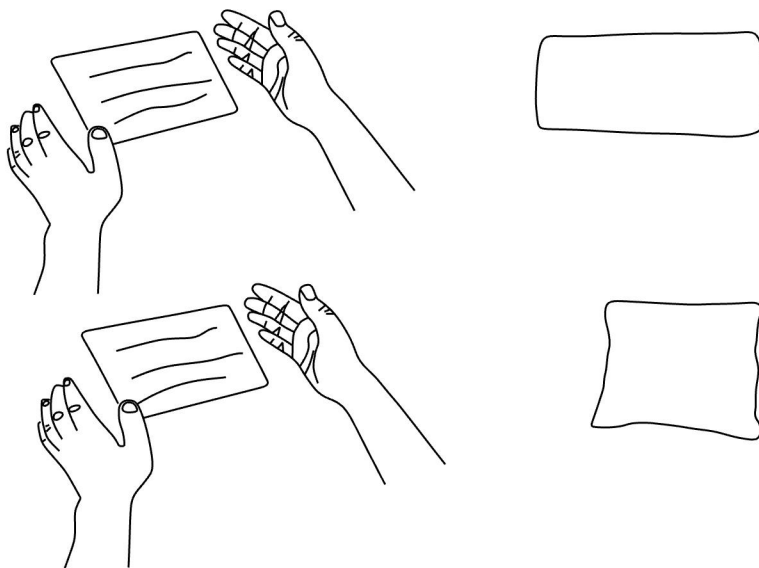

Fluff up the pillows and back cushion for enough comfort.

ASSEMBLY INSTRUCTION

STEP4. Use the box opener again to cut open the second package layer.

Attention: The sofa will be released from the vacuum state and begin to inflate.

Please ensure safety during this step to avoid injury from the expanding sofa.

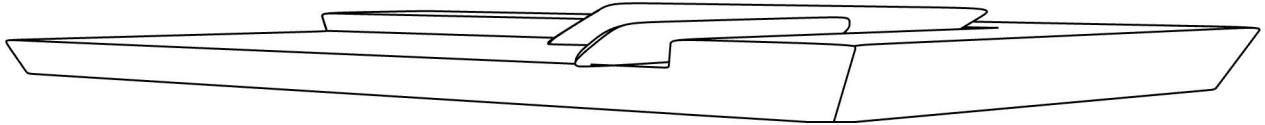

Tips:

1. After cutting open the first package layer and taking it off, you can lay the left packaged sofa flat on the floor.
2. Please carefully cut open the second package layer to avoid damaging the sofa upholstery.
3. After this step, the sofa will expand and restore to its original fluffy state after about 72 hours.

ASSEMBLY INSTRUCTION

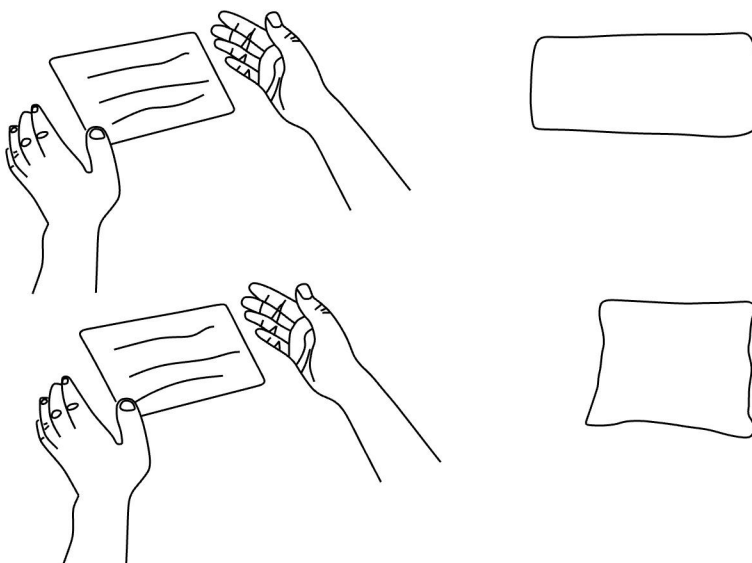

Fluff up the pillows and back cushion for enough comfort.

ASSEMBLY INSTRUCTION

STEP5:Wait for the sponge to expand for about 72 hours until the sofa restores to its original fluffy state.Take out the sponge from the expanded sofa holes.

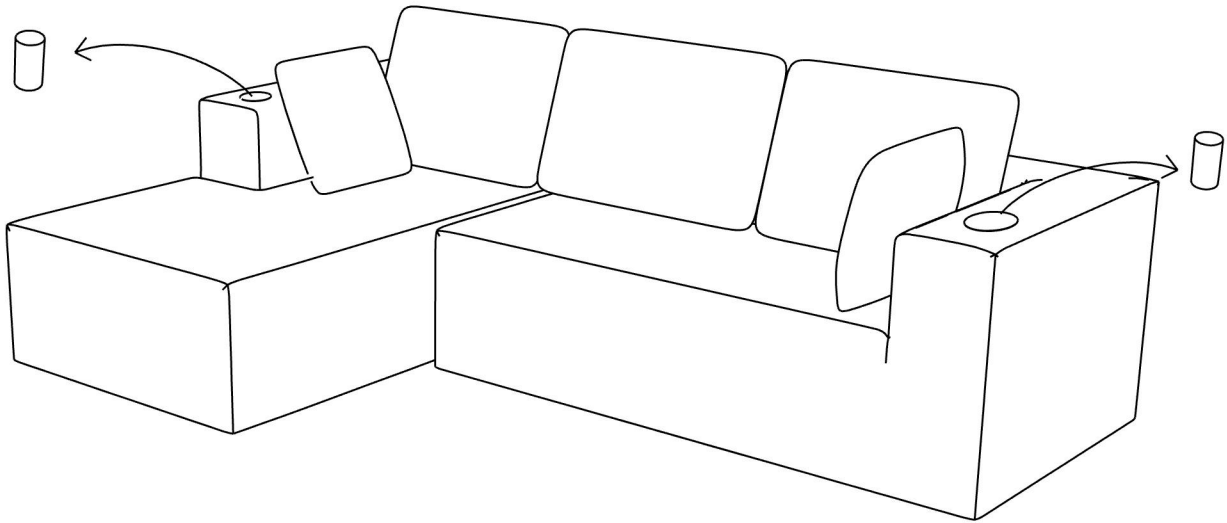

ASSEMBLY INSTRUCTION

STEP6:Put the cup holder into the hole.

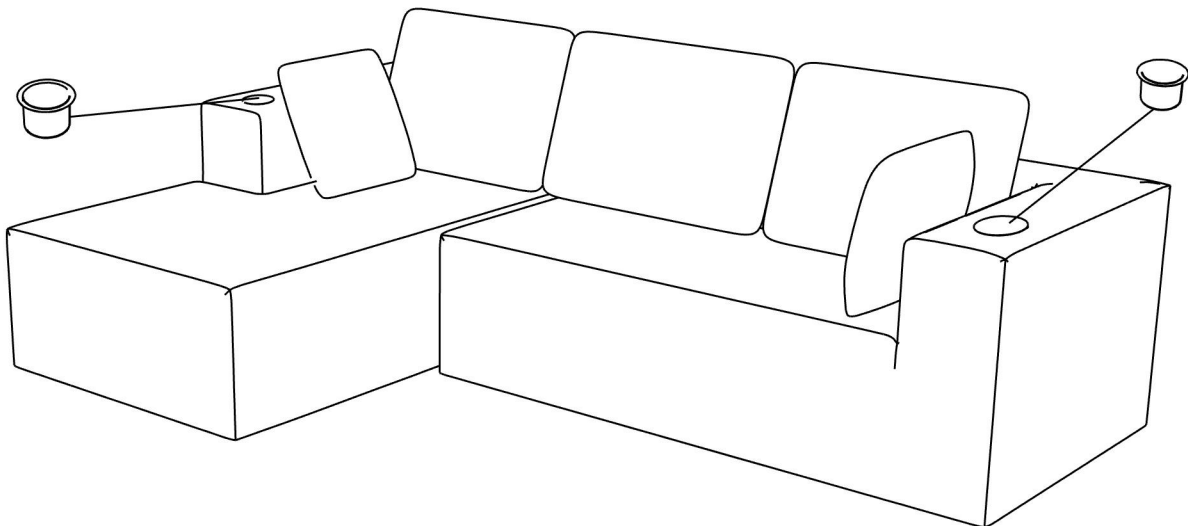

ASSEMBLY INSTRUCTION

STEP7: Lazy sofa form.

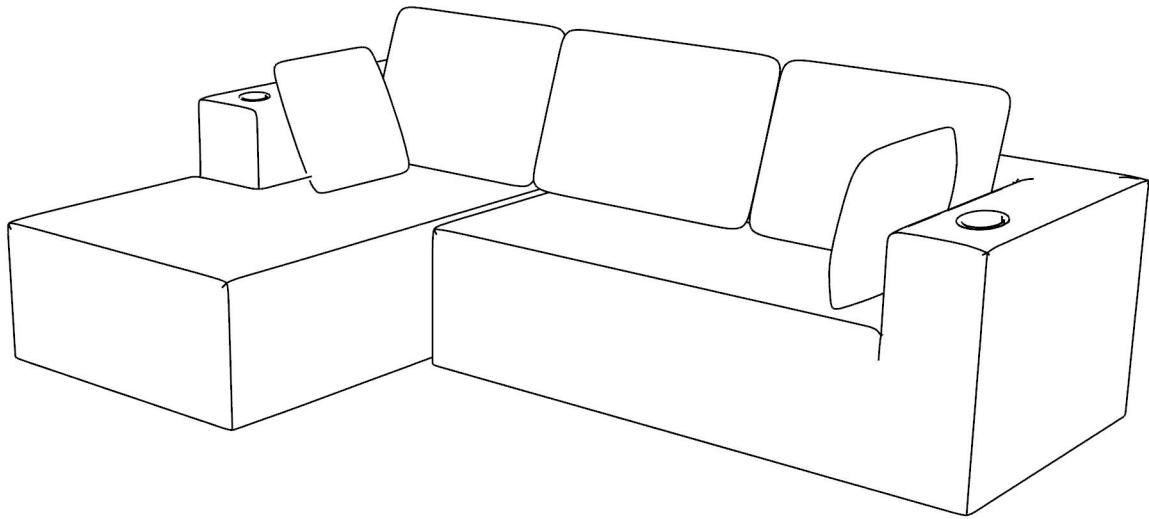

COMPLETE!

Attention

When you find wrinkles on the sofa, you can use a steam electric iron (set to no more than 100°C) to smooth them out. Below is an example for reference.

