

ASSEMBLY INSTRUCTION

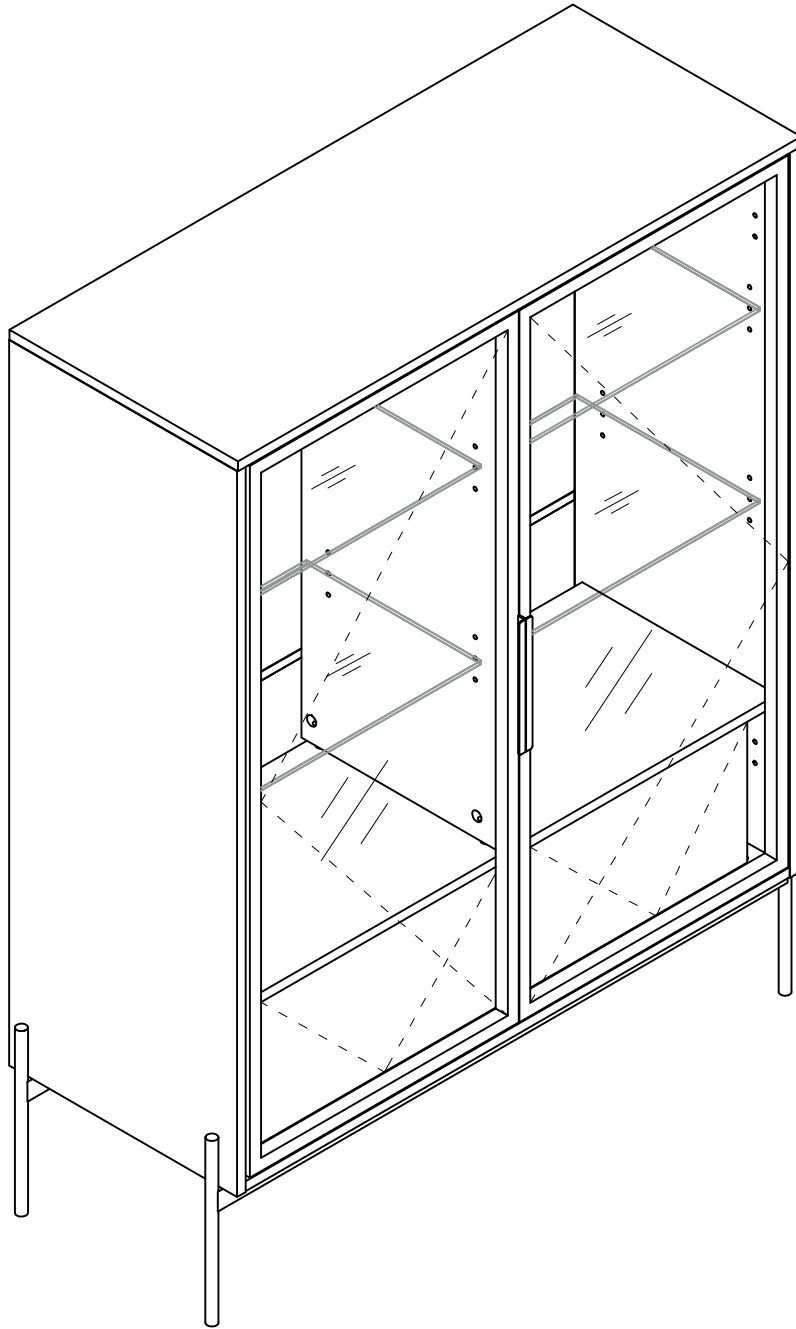

1. Thank you for choosing *our products*.

2. Return Policy







DO NOT RETURN TO THE STORE! Skip the process of returning your product and contact us directly for a replacement

If you find that parts of your order are missing or damaged, we will gladly ship any needed replacement parts free of charge.

If your product's quality does not meet your expectations or you have found any sort of defect, please contact our customer service department and let us know the details of your order and any issues encountered, we will try our best to provide you with a solution. Feel free to also directly contact our manufacturer concerning needed replacement parts and they will be happy to help provide you with a solution or answer any questions you may have.

Recommendations Before Beginning Assembly

-  • Read instructions, cover to cover
-  • Have 2-4 adults on hand for assembly depending on product size
-  • Do not assemble directly on flooring or carpet
-  • Assemble on a clean non-marring surface (example: packing foam)
-  • Save all packaging until finished

3. Assembly Notice:

- If you encounter any problems during assembly and find that you cannot continue, rest assured we will help you solve the situation as soon as possible. Simply keep all of the parts of the product stored in a safe place and contact us immediately so we may assist you further.
- Once you have opened your package, remove all inner hardware packages and take the parts out. One by one, Place the parts out neatly in front of you, then refer to the instructions to ensure no parts are missing. If any pieces are found missing, please carefully look in the box first, as the hardware packaging might have torn making the hardware spill in the box.
- Some key parts of your product may be stored and hidden inside of other parts. Please open any zippered or hook & loop storage compartments to remove all parts. (example: cushions and legs being stored in the underside of a sofa)
- **IMPORTANT:** When setting up your product, **DO NOT INSTALL THE SCREWS ALL THE WAY IN THE BEGINNING.** Place each screw into their proper hole and use your hand to twist the screw halfway. Twist all the screws in halfway to ensure the holes will match up properly and the product is level on the ground. When everything seems fitted, then tighten the screws.

- When you have completed assembly, we suggest you have more than one person to assist you with lifting and placing the product.

Care & Maintenance

- ☞  • Do not put hot items directly on furniture surface
- ☞  • Do not clean furniture with harsh cleansers or polish
- ☞  • Do not place furniture under direct sunlight
- ☞  • Do not place furniture near heating or cooling vents
- ☞  • Do not write on furniture without a padded barrier to protect the surface
- ☞  • Do not place furniture outside. For indoor use only
- ☞  • Not for commercial use. For residential use only
- ☞  • Stains may be removed with mild soap solution and damp cloth
- ☞  • Children should not climb or jump on the furniture
- ✓  • Dust and pick-up spills using a clean, non-colored, lint-free cloth





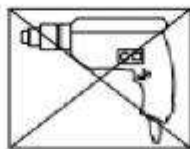



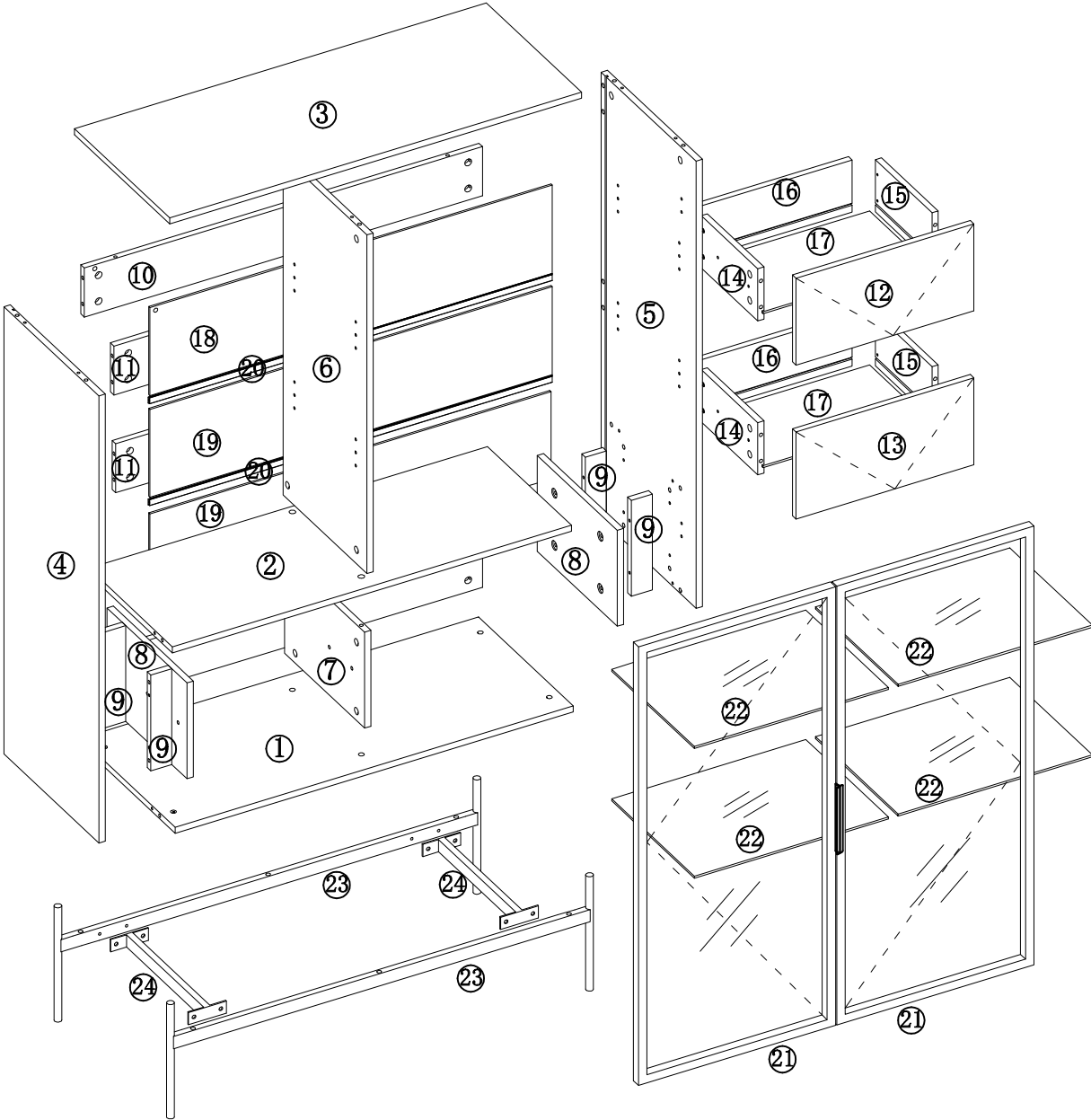

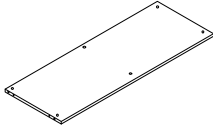
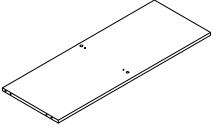
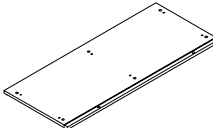
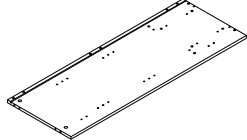
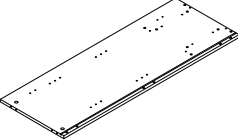
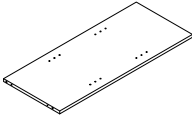
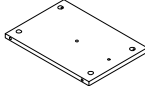
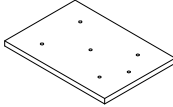
Caution

- This product contains small components. Please ensure that they are kept away from small children.

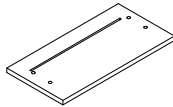
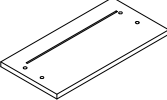
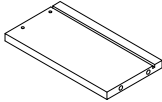
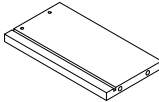
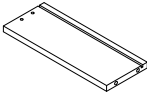
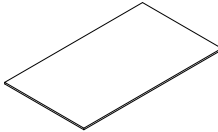



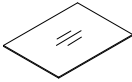
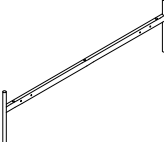



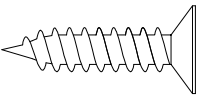
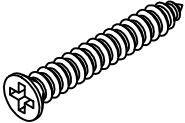
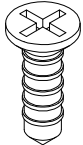
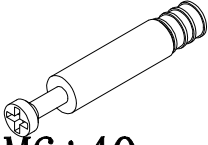
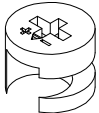
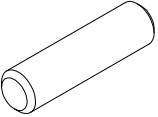
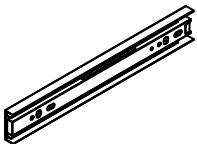
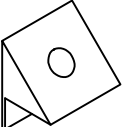
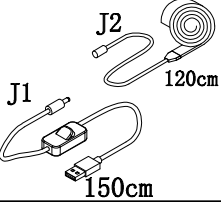

Part List

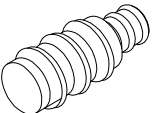

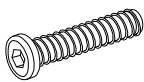
			
① x1pc	② x1pc	③ x1pc	④ x1pc
			
⑤ x1pc	⑥ x1pc	⑦ x1pc	⑧ x2pcs
			
⑨ x4pcs	⑩ x1pc	⑪ x2pcs	⑫ x1pc
			
⑬ x1pc	⑭ x2pcs	⑮ x2pcs	⑯ x2pcs
			
⑰ x2pcs	⑱ x1pc	⑲ x2pcs	⑳ x2pcs
			
㉑ x2pcs	㉒ x4pcs	㉓ x2pcs	㉔ x2pcs

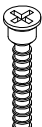
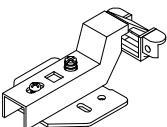
Hardware list

 M3.5*14mm	 M4*40mm	 M4*6mm	 M6*40mm	 Ø12*10mm
Ⓐ x56pcs	Ⓒ x8pcs	Ⓓ x8pcs	Ⓔ x50pcs	Ⓕ x50pcs
 Ø6*30mm			 J1 150cm J2 120cm	
Ⓖ x24pcs	Ⓗ x2pcs	Ⓘ x12pcs	Ⓙ x1pc	Ⓚ x4pcs
		 M6*40mm	 M6*10mm	 M4
Ⓛ x16pcs	Ⓜ x1pc	Ⓝ x6pcs	Ⓞ x8pcs	Ⓟ x1pc
 M7*38mm				
Ⓠ x8pcs	Ⓡ x4pcs	Ⓢ x50pcs		

Note: One 5V 2A USB Type A charger required to power the LED light strip.(Not Included)

Hardware list

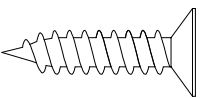
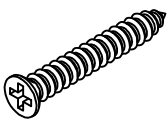
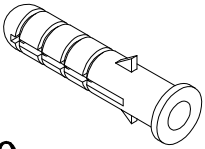
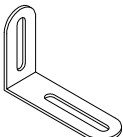

 M3.5*14mm	 M4*30mm	 30mm	
Ⓐ x2pcs	Ⓑ x2pcs	Ⓙ x2pcs	Ⓚ x2pcs

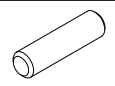
Step 1

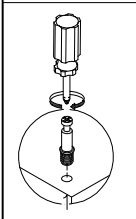
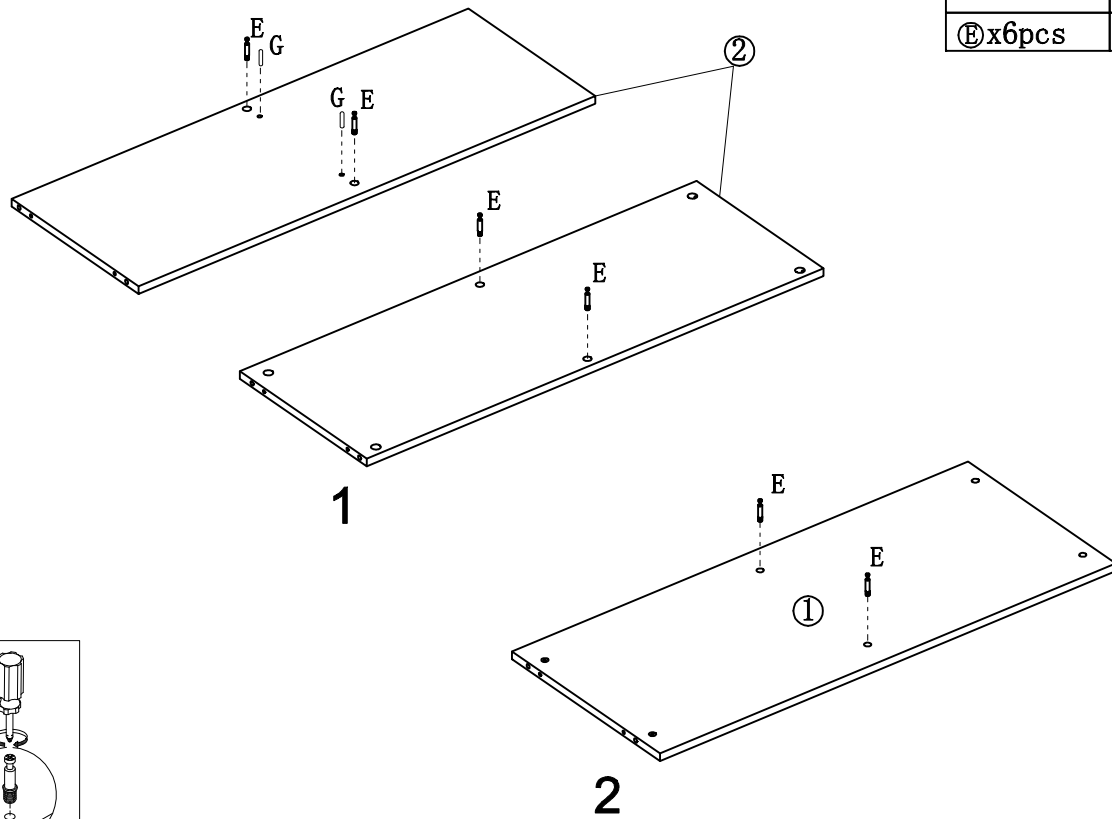
	
Ⓔ x6pcs	Ⓒ x2pcs



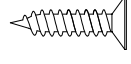

Step 2

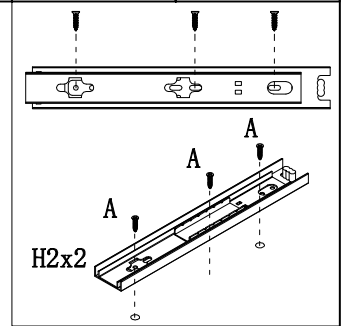
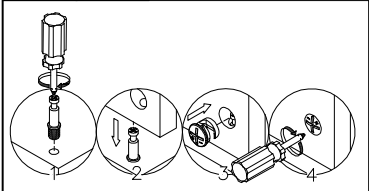
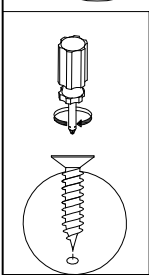
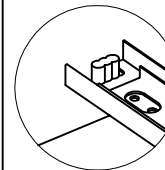
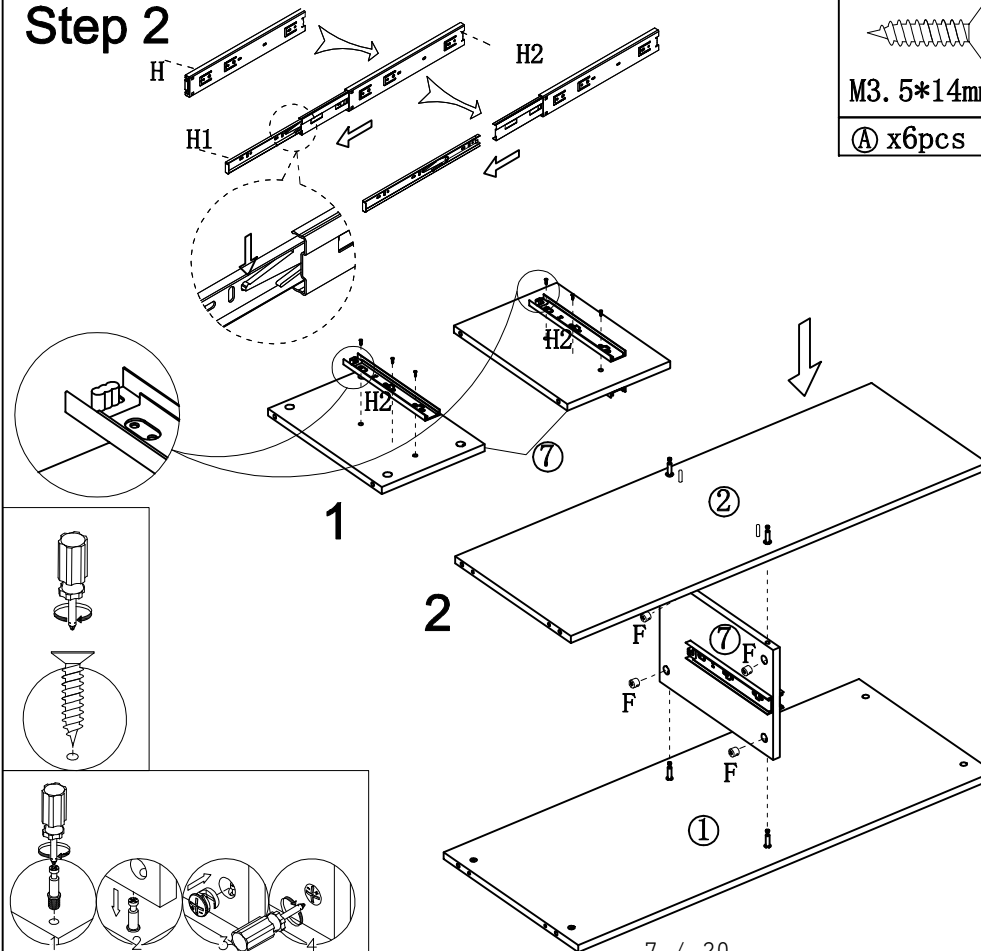

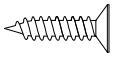
		
Ⓐ x6pcs	Ⓕ x4pcs	Ⓗ x2pcs





Ⓐ x56pcs

	
Ⓑ x2pcs	Ⓒ x8pcs

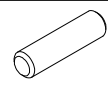
Step 3

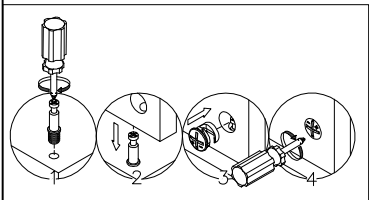
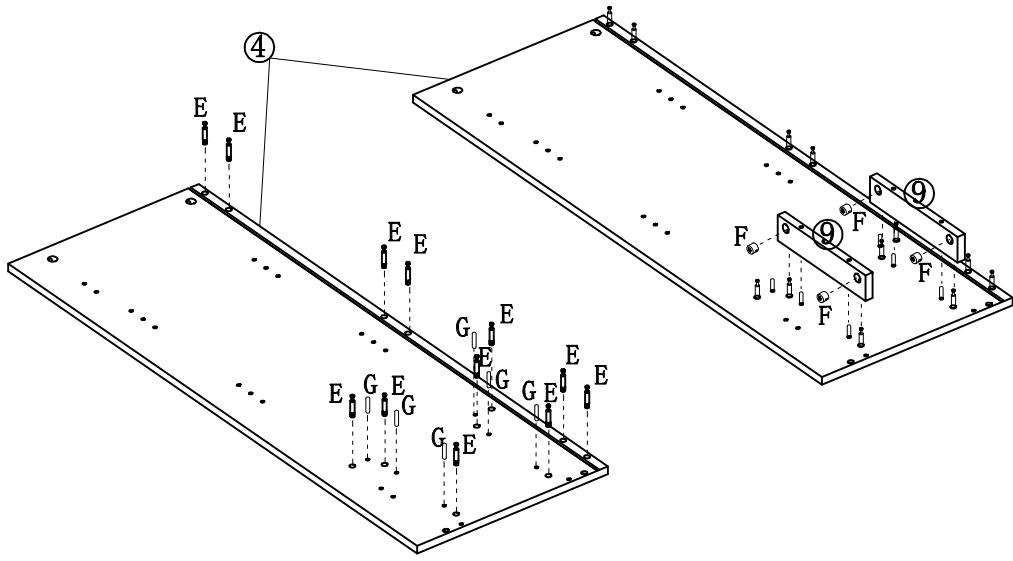
 M6*40mm	 Ø12*10mm	 Ø6*30mm
Ⓔ x12pcs	Ⓕ x4pcs	Ⓖ x6pcs



Step 4

 Ø12*10mm
Ⓕ x4pcs

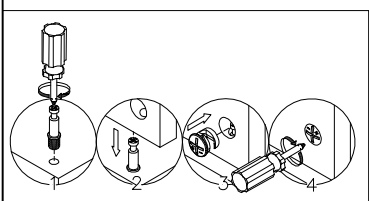
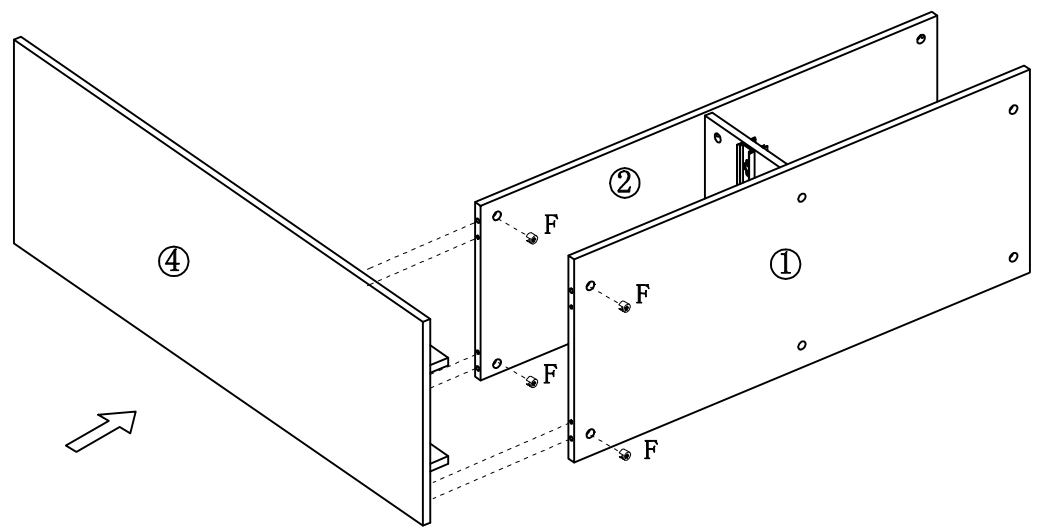

Step 5



Ø12*10mm

ⓕ x2pcs

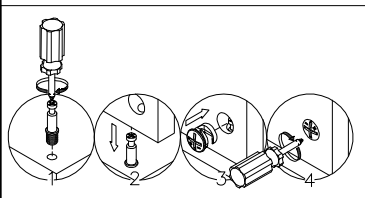
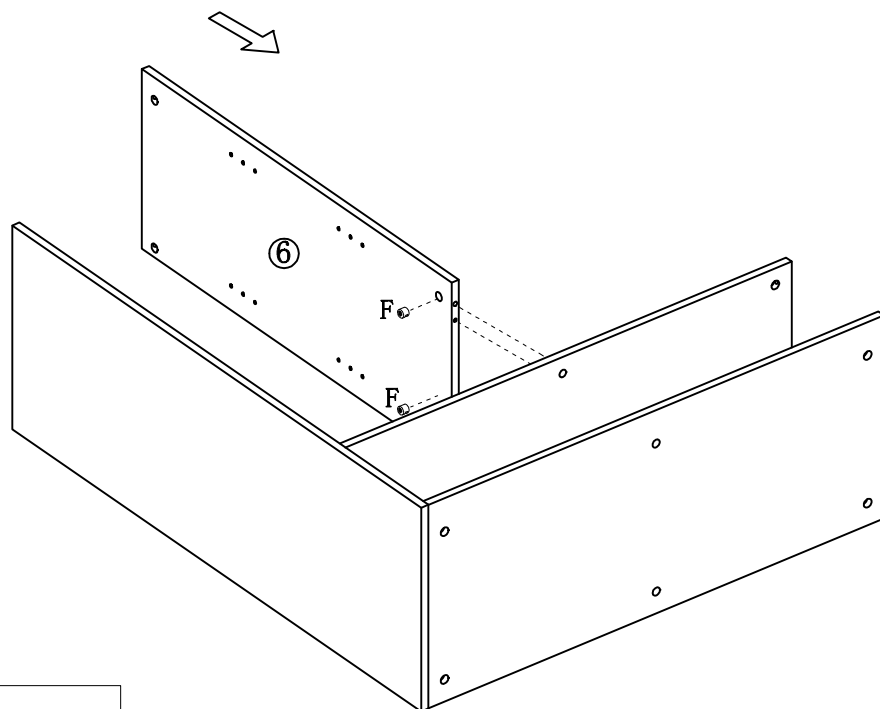

Step 6



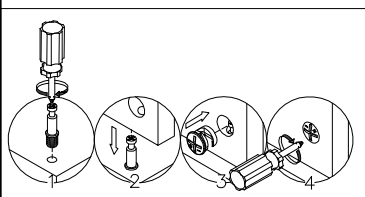
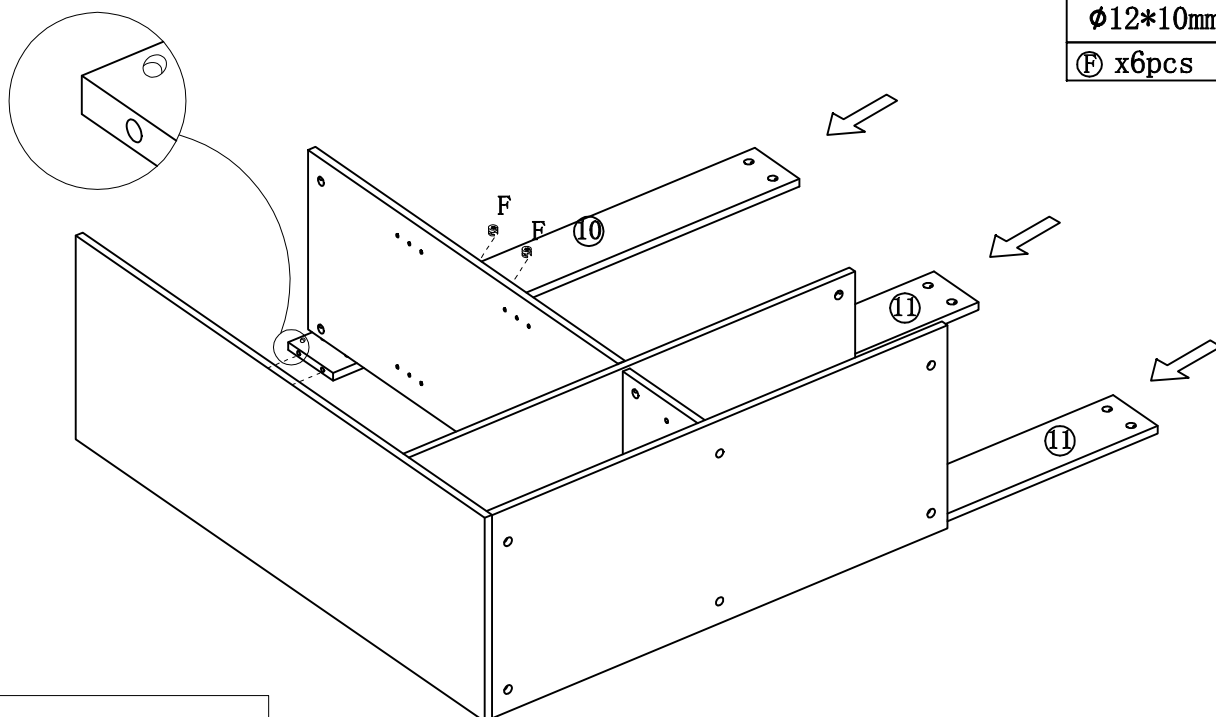

Ø12*10mm

ⓕ x6pcs

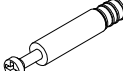

Step 7

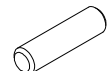
 M6*40mm	 φ12*10mm	 φ6*30mm
Ⓔ x12pcs	Ⓕ x4pcs	Ⓖ x6pcs

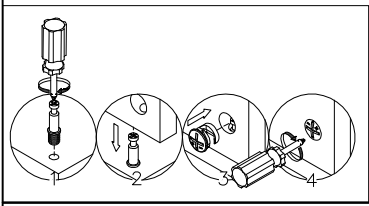
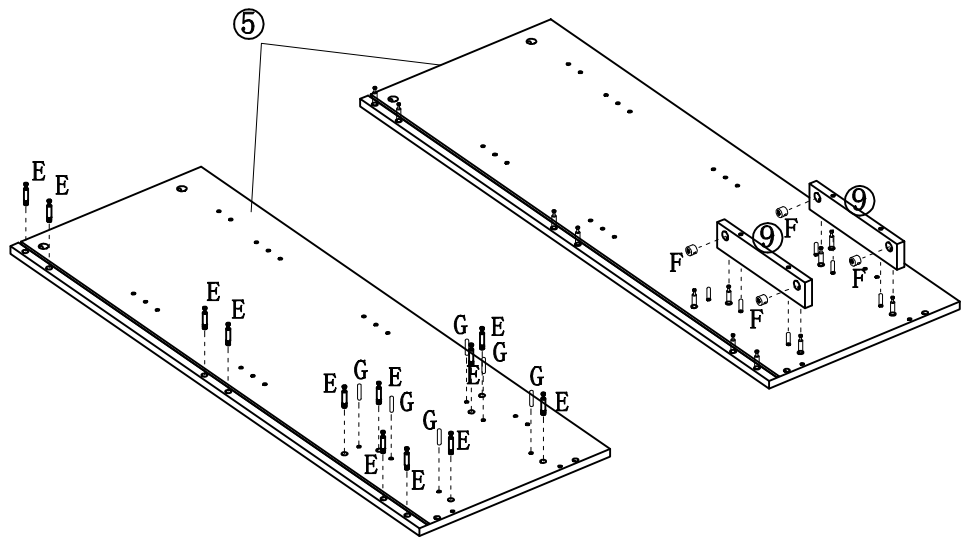

Step 8

 φ12*10mm
Ⓕ x10pcs

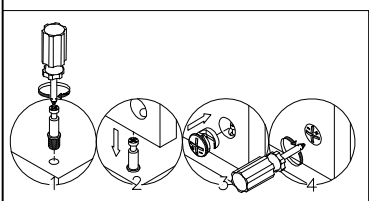
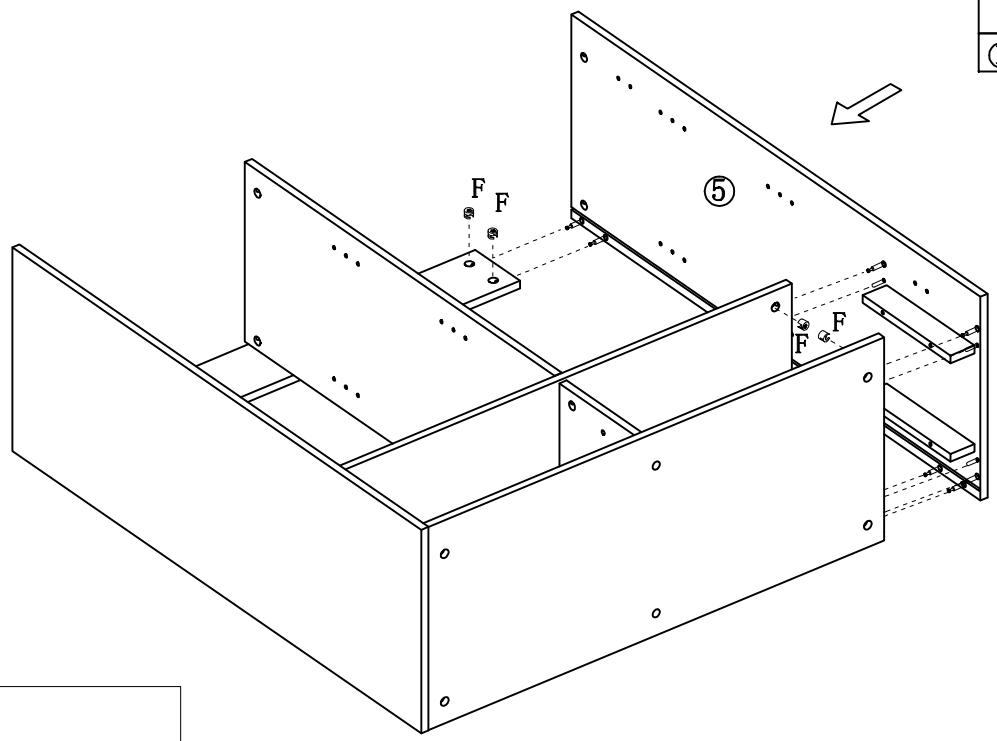

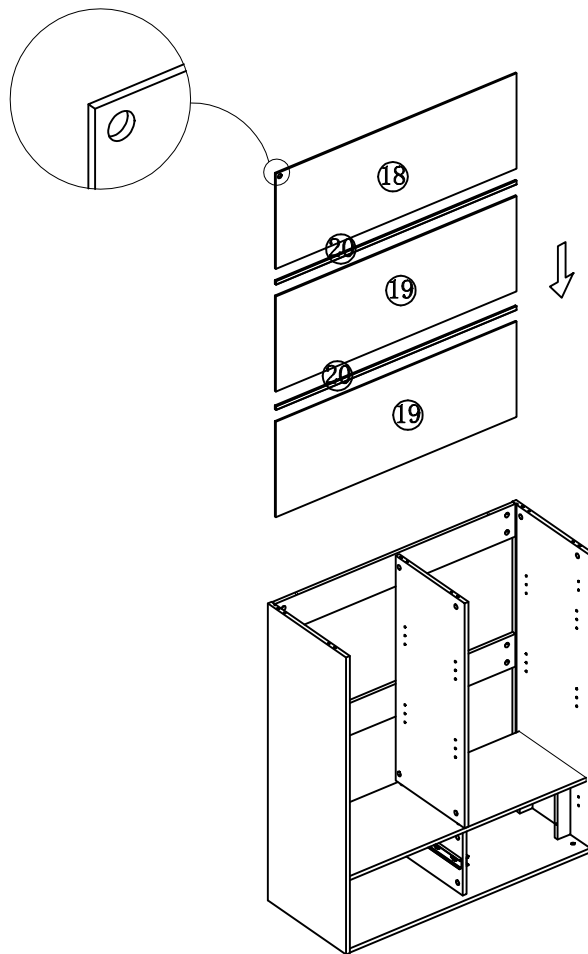

Step 9

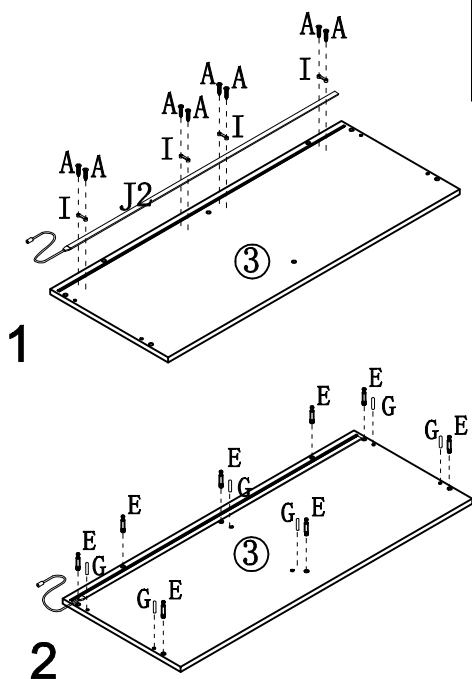

Step 10

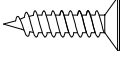
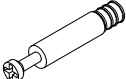

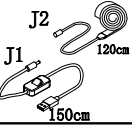
				
M3. 5*14mm	M6*40mm	Ø6*30mm	Ø12*10mm	J2 120cm J1 150cm
Ⓐ x8pcs	Ⓑ x8pcs	Ⓒ x6pcs	Ⓕ x8pcs	Ⓓ x1pc

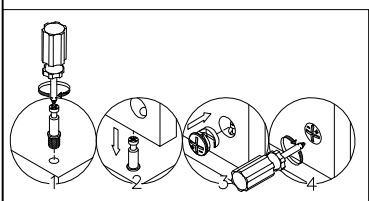
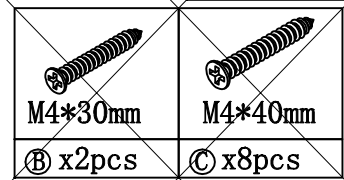
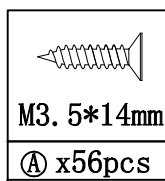
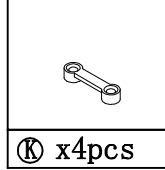

Step 11

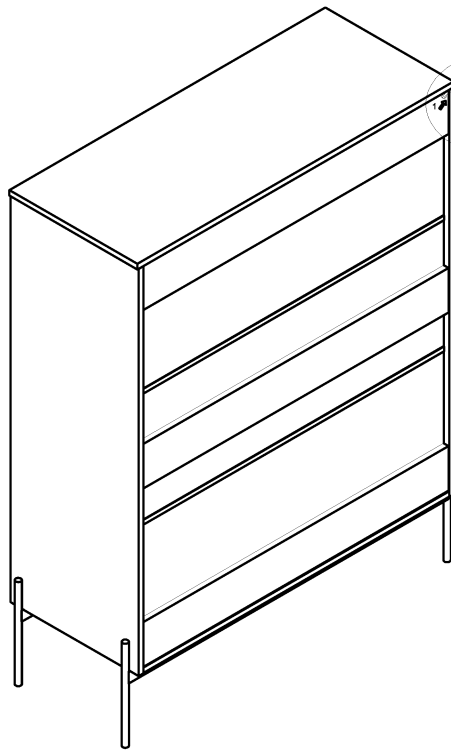

J2 J1:150cm

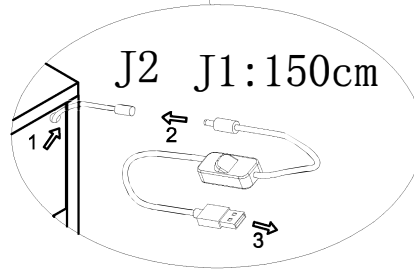
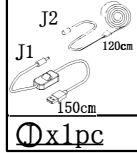

Note: One 5V 2A USB Type A charger required to power the LED light strip.(Not Included)

Step 12

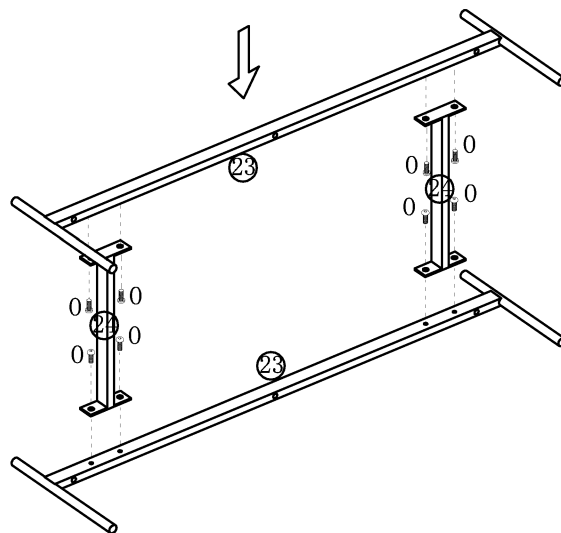

M6*10mm

⓪x8pcs



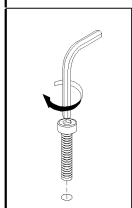

M4

Ⓟ x1pc



Step 13

	
M6*40mm	M4
Ⓝ x6pcs	Ⓟ x1pc

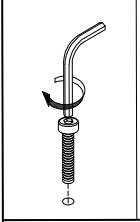
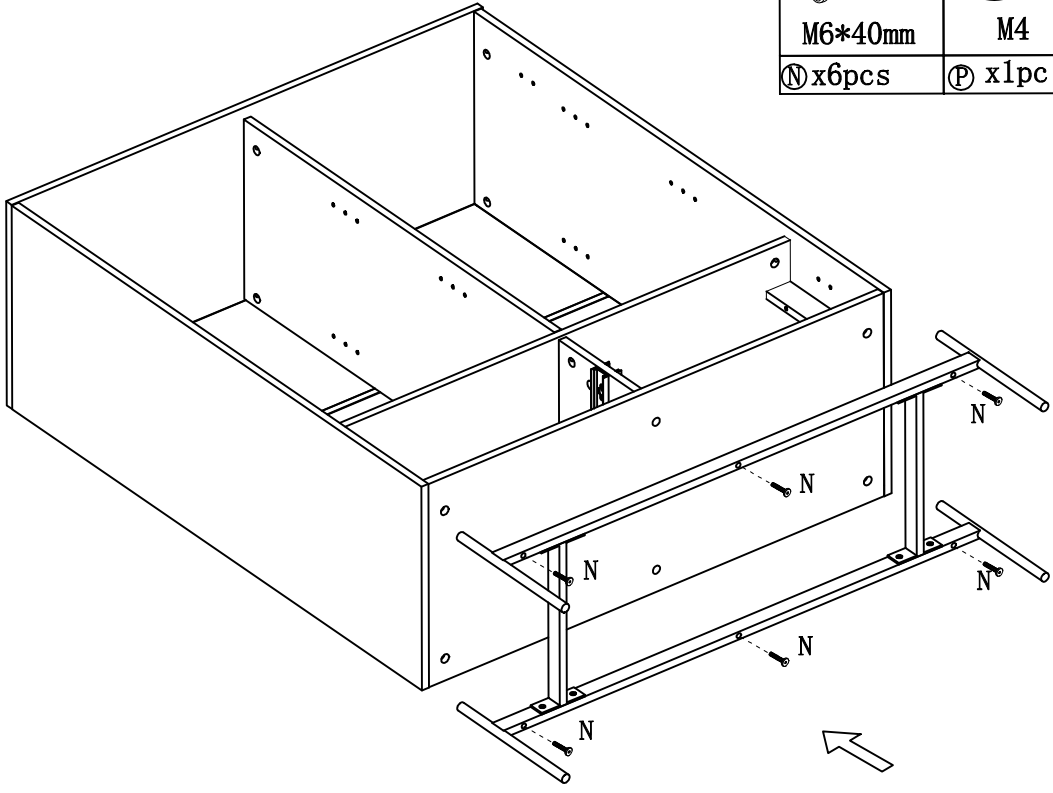

Step 14



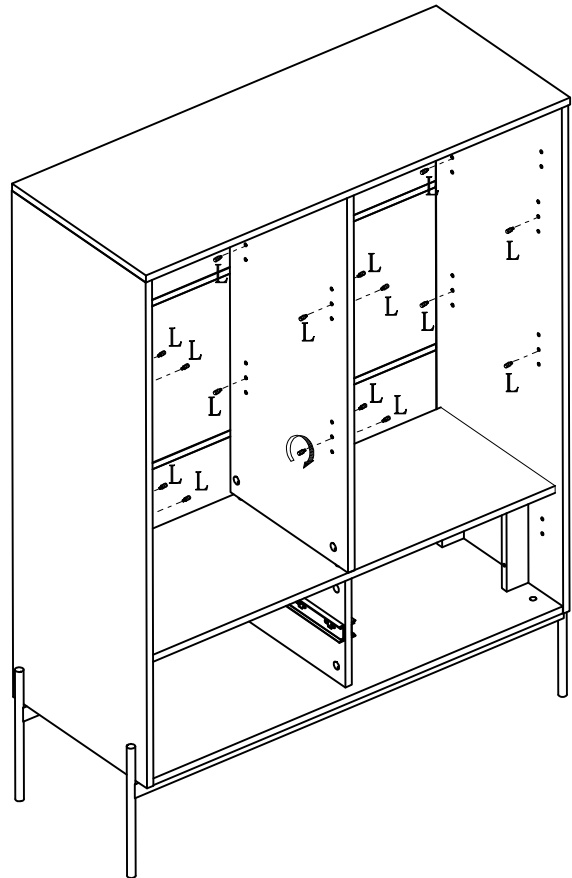

Ⓞ x16pcs

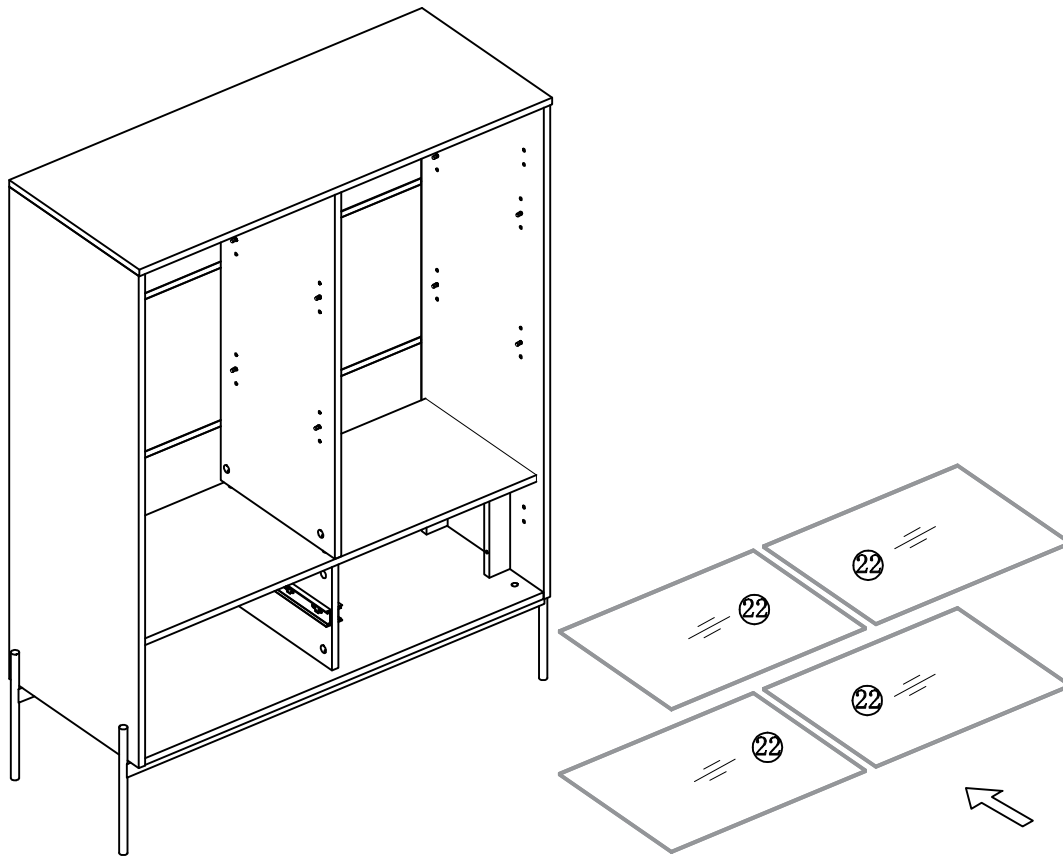

Step 15

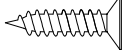

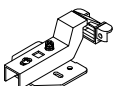
Step 16

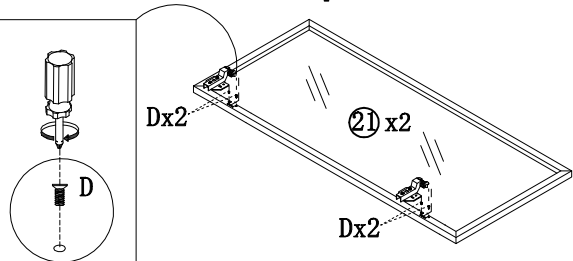

		
M3. 5*14mm	M4*6mm	
Ⓐ x16pcs	Ⓓ x8pcs	Ⓡ x4pcs

1

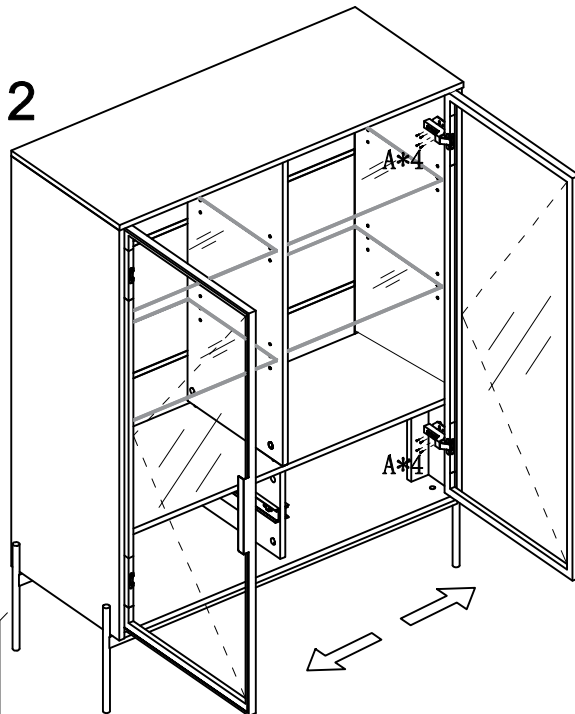

2

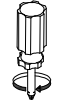

		
M3. 5*14mm	M4*30mm	M4*40mm
Ⓐ x56pcs	Ⓑ x2pcs	Ⓒ x8pcs

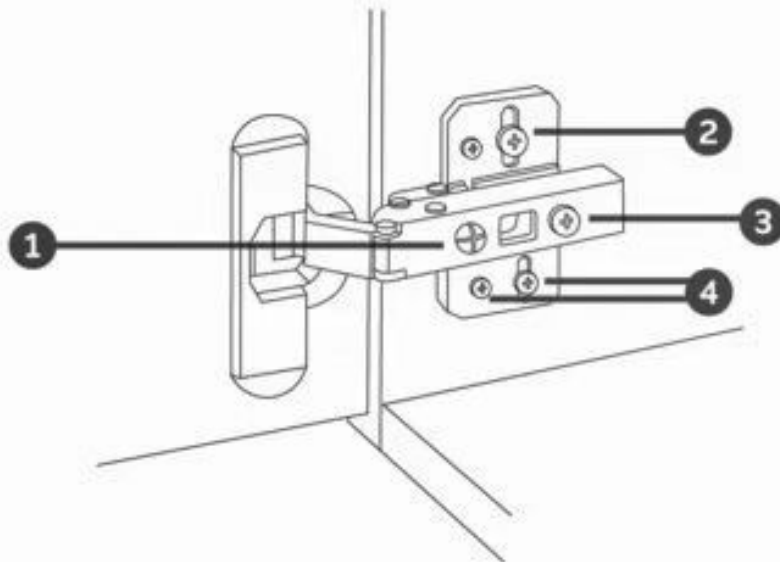

1 Sideways / Tilt adjustment

Turn the screw
clockwise to move the door further away from
 the side of the cabinet
anticlockwise to move the door closer to the
 side of the cabinet

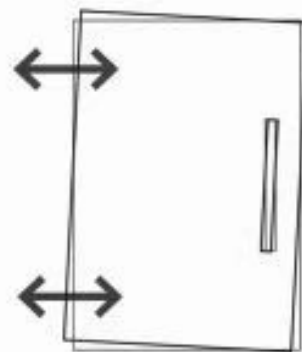

2 4 Height adjustment

While supporting the weight of the door, turn the
 screws
clockwise to move the door up
anticlockwise to move the door down

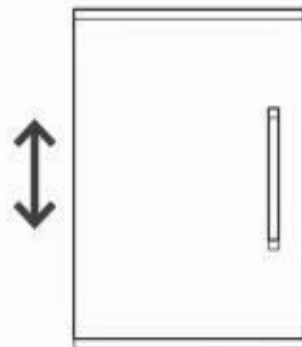

3 Forward and back adjustment

If the gap between the back of the door and the
 cabinet is too small, and the door may not close
 fully. Turn the screw
clockwise to decrease the gap between the
 door and the cabinet
anticlockwise to increase the gap between the
 door and the cabinet



Step 17

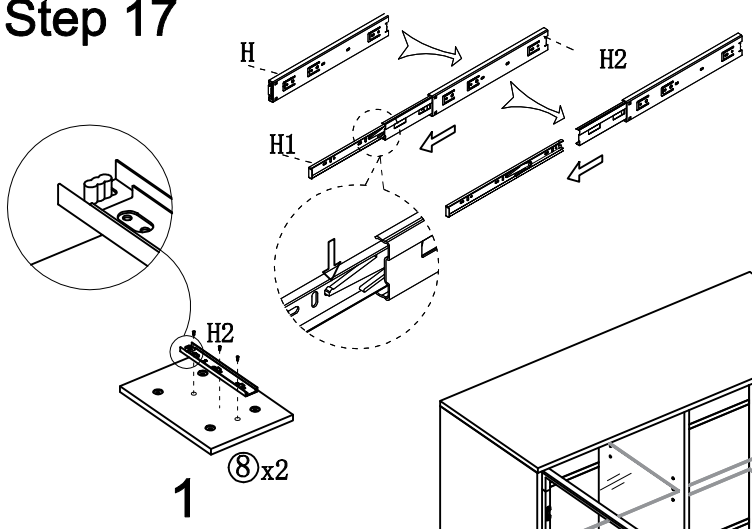

M3.5*14mm	H	M7*38mm
A x6pcs	H x2pcs	Q x8pcs

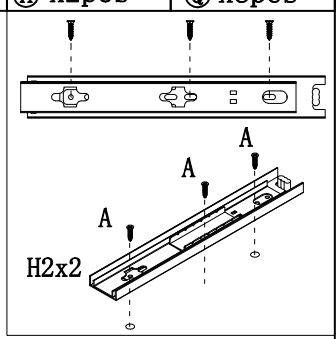

2

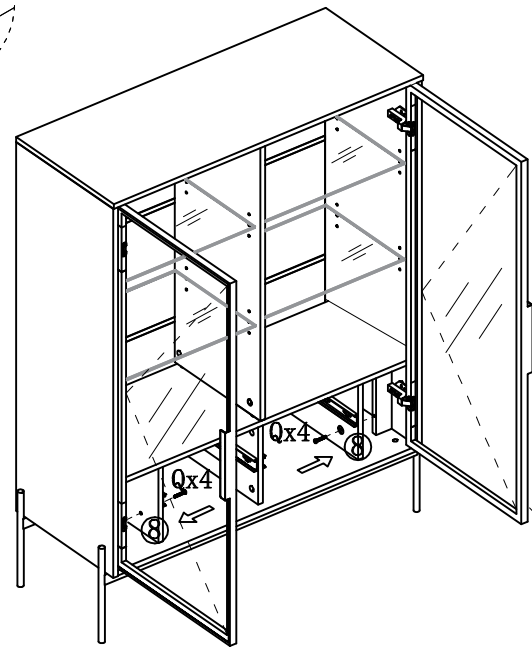

M3.5*14mm
A x56pcs

M4*30mm	M4*40mm
B x2pcs	C x8pcs

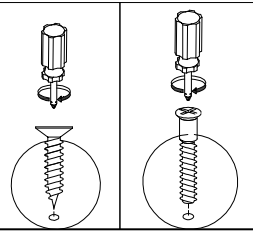

Step 18

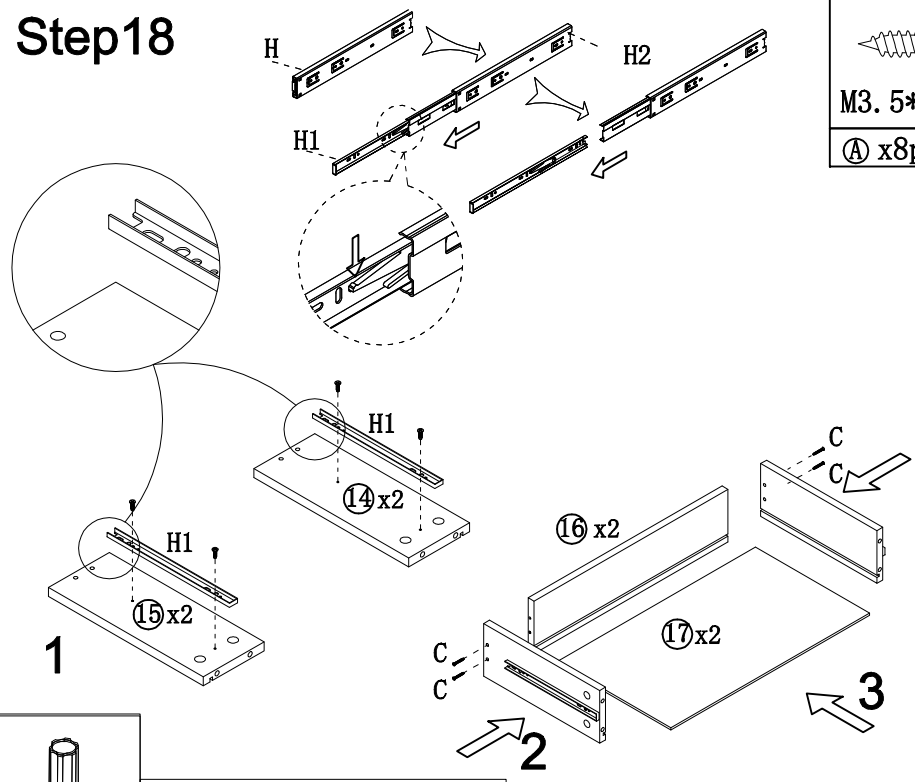

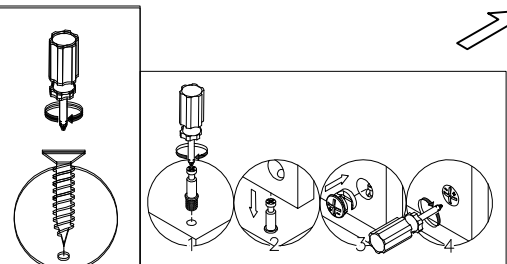
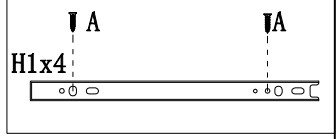

M3.5*14mm	M4*40mm	H
A x8pcs	C x8pcs	H x2pcs



M3.5*14mm	M4*30mm	M4*40mm
A x56pcs	B x2pcs	C x8pcs

Step 19

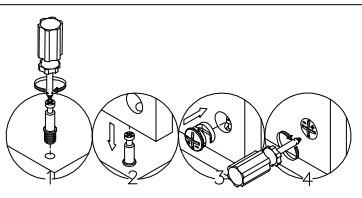
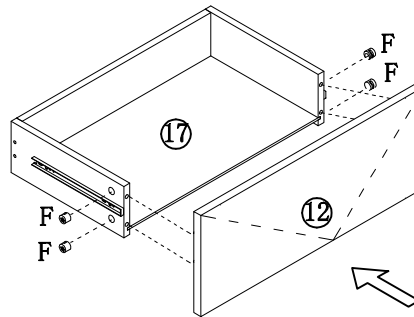
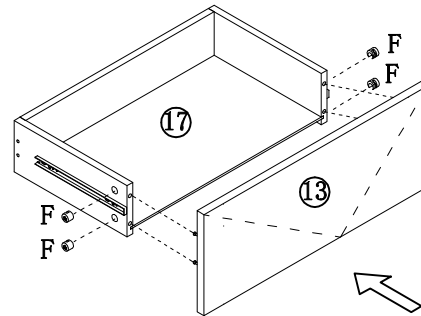
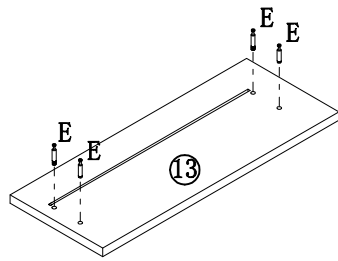
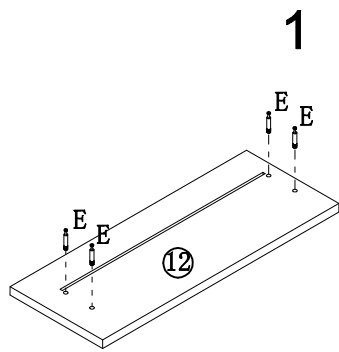

 M6*40mm	 Ø12*10mm
Ⓔ x50pcs	Ⓕ x50pcs



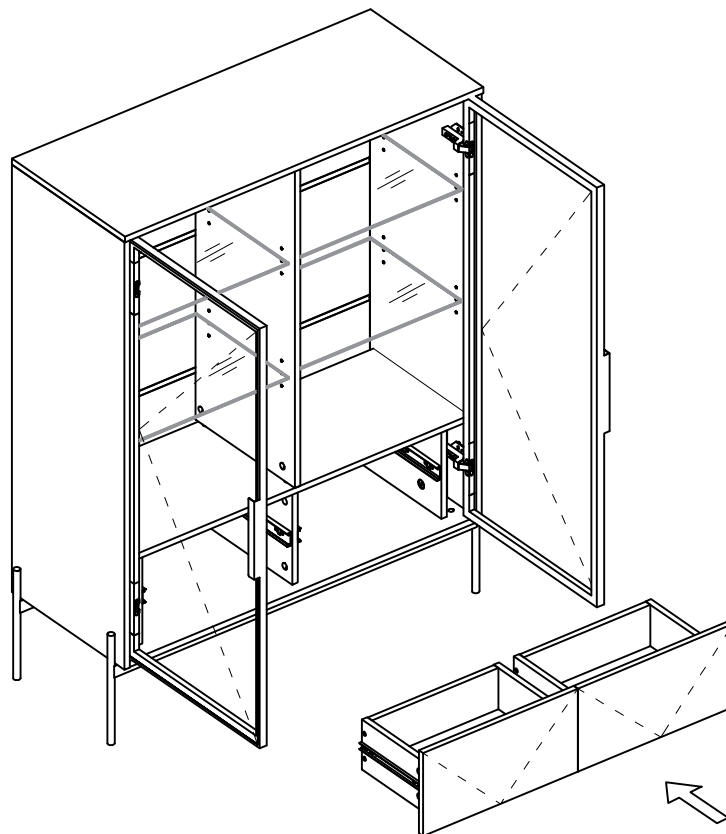

Step 20

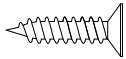

Step 21

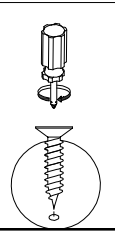
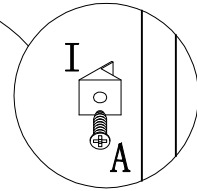
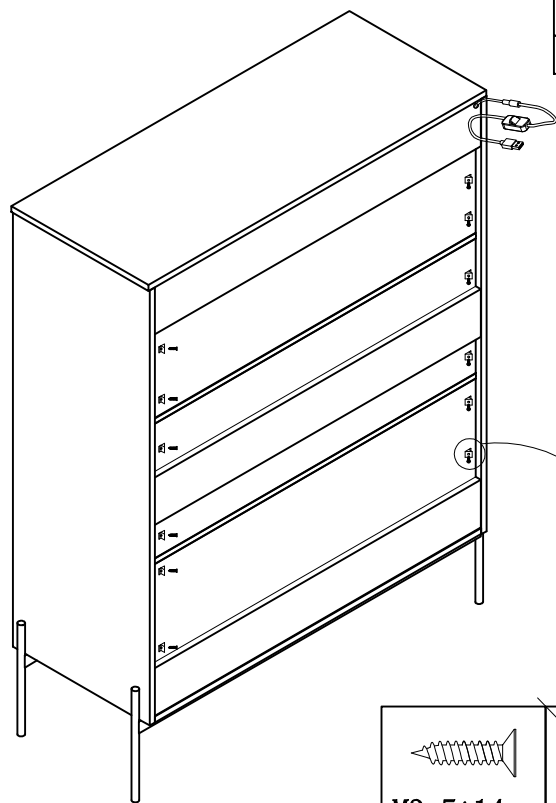
	
M3. 5*14mm	
Ⓐ x12pcs	Ⓛ x12pcs

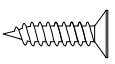



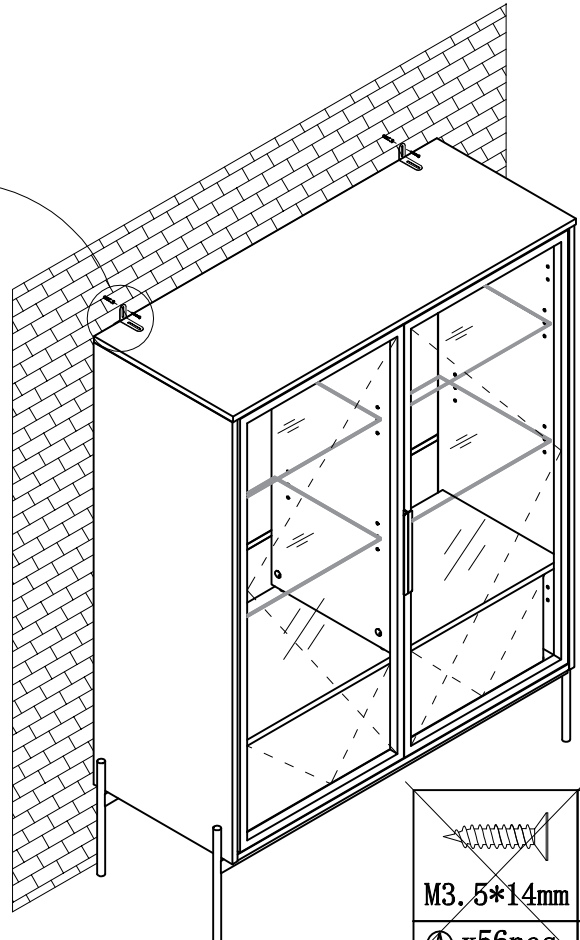
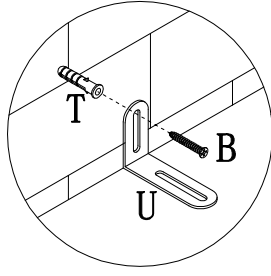

		
M3. 5*14mm	M4*30mm	M4*40mm
Ⓐ x56pcs	Ⓑ x2pcs	Ⓒ x8pcs

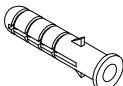
Step 22

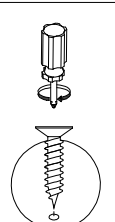
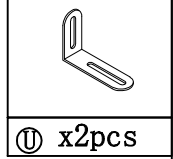

	
M4*30mm	30mm
Ⓑ x2pcs	Ⓛ x2pcs



		
M3. 5*14mm	M4*30mm	M4*40mm
Ⓐ x56pcs	Ⓑ x2pcs	Ⓒ x8pcs

Step 23

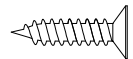
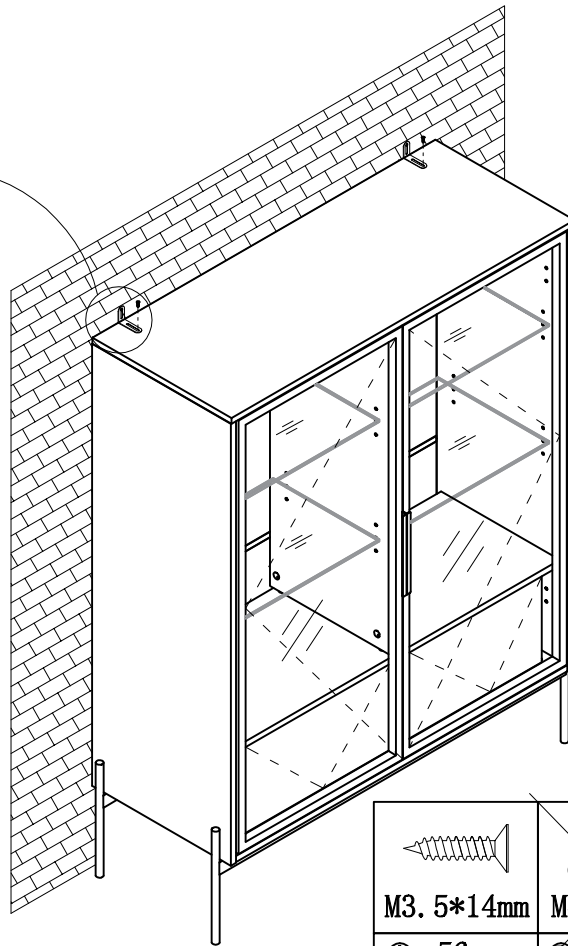
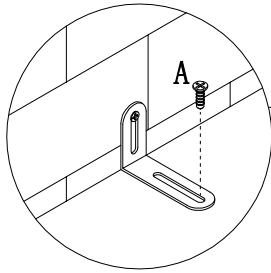

M3. 5*14mm

Ⓐ x2pcs

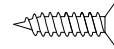
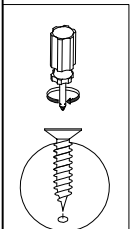

M3. 5*14mm

Ⓐ x56pcs



~~M4*30mm~~

~~Ⓑ x2pcs~~



~~M4*40mm~~

~~Ⓒ x8pcs~~

Attention: For safety and stability, we suggest securing the anti-tip accessories to the wall to prevent tipping, injury, and property damage.

Note: One 5V 2A USB Type A charger required to power the LED light strip.(Not Included)

Step24

●
Ⓢ x50pcs

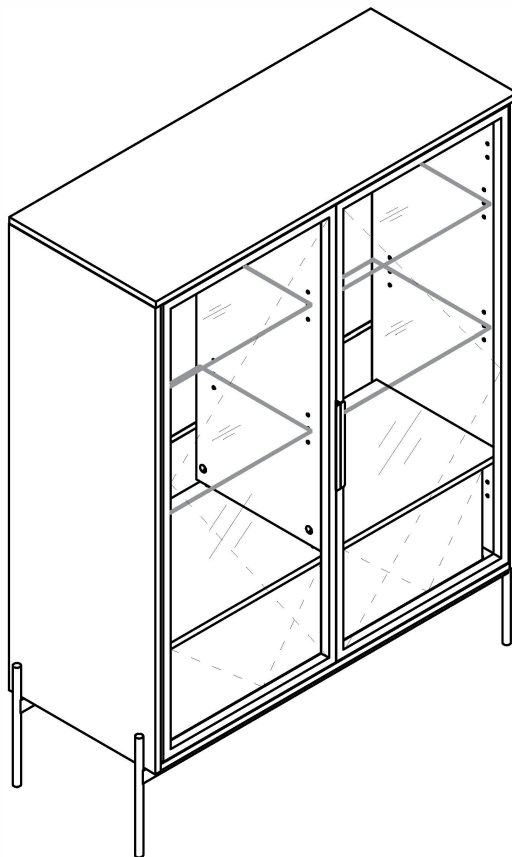
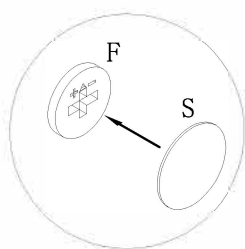

After installing the product, stick the number S on the perforated position