

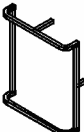





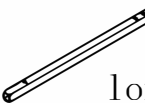

Installation & Assembly

STEP 1

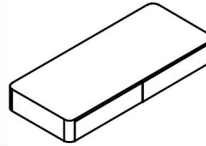
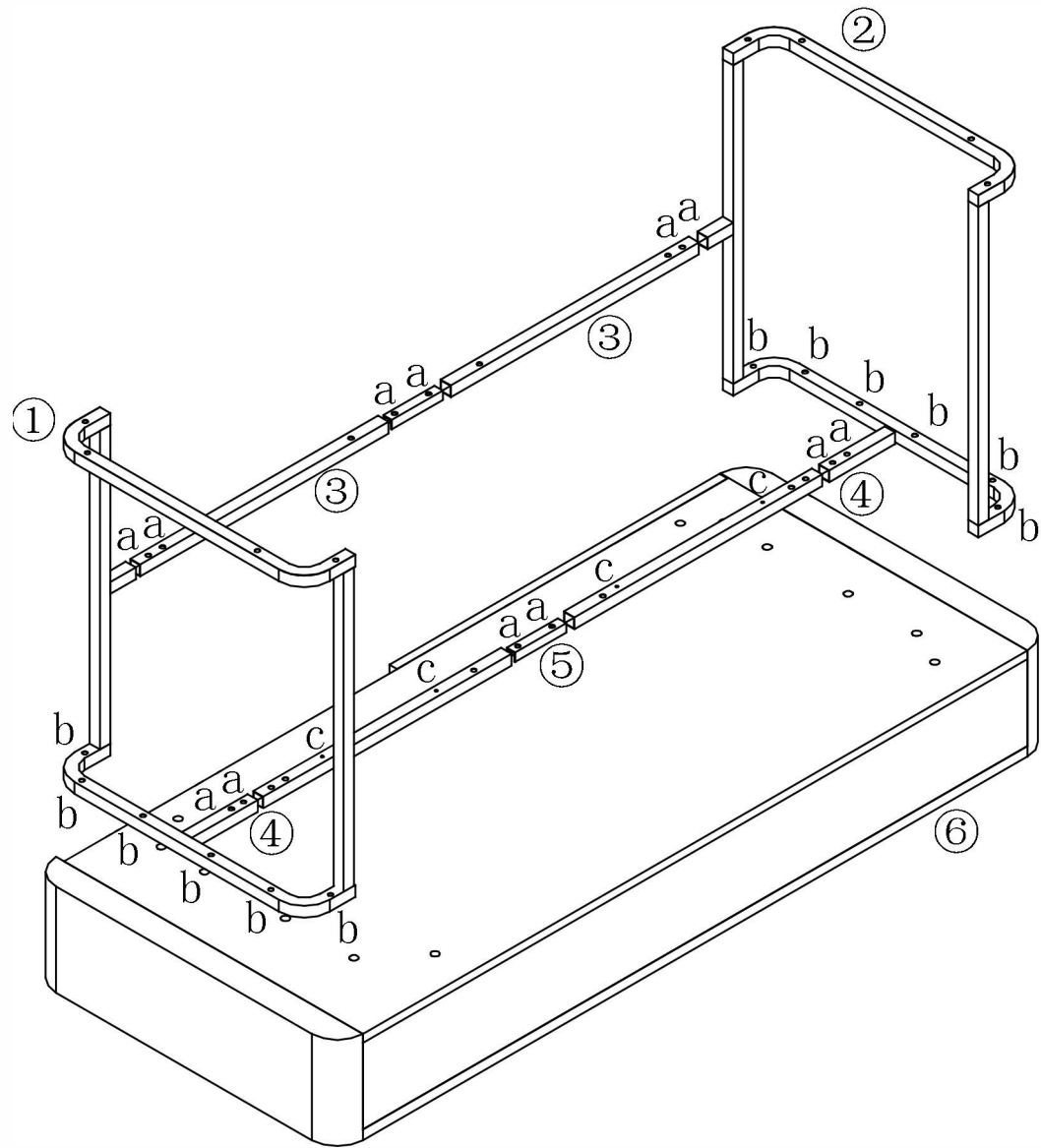
NO.	Parts	Quantity
①		1
②		1
③	 short	2
④	 long	2
⑤		2
⑥		1



STEP 2

NO.	Parts	Quantity
a	 M8*15=12	12
b	 M6*35=12	12
c	 M4*20=4	4

