







# FMIU020X



<b>Product family</b>	Microwave oven
<b>Category</b>	Built-in
<b>Installation</b>	With frame
<b>Power source</b>	Electrical
<b>Cooking Method</b>	Microwave with grill
<b>Oven controls</b>	Electro-mechanical



## Programs / Functions

<b>Number of functions</b>	6
<b>Large grill</b>	
<b>Pizza</b>	
<b>Defrost by time</b>	
<b>Defrost by weight</b>	
<b>Microwave</b>	
<b>Microwave + grill</b>	
<b>Automatic programs</b>	8

## Controls

<b>Display</b>	1 LED	<b>No. of controls</b>	1
<b>Controls</b>	Controls knobs / Buttons	<b>Control knobs</b>	Push-push
<b>Opening</b>	Button	<b>Controls color</b>	Stainless steel effect

## Options



<b>Timer</b>	Electronic	<b>Child safety lock</b>	Yes
<b>Time-setting options</b>	End-of-cooking	<b>Quick-start option</b>	Yes
<b>End-of-cooking acoustic alarm</b>	Yes		

## Technical Features



<b>Cavity material</b>	Stainless steel	<b>Grill - power</b>	1000 W
<b>No. of lights</b>	1	<b>Total no. of door glasses</b>	1
<b>Lighting</b>	LED	<b>Security Thermostat</b>	Yes
<b>Turntable</b>	Yes	<b>Cooling system</b>	Tangential
<b>Turntable dimensions</b>	24.5 "	<b>Microwave door protection screen</b>	Yes
<b>Light on when door is open</b>	Yes	<b>Microwave stops when door is opened</b>	Yes
<b>Grill type</b>	Heating element	<b>Microwave effective power</b>	800 W

## Accessories Included

<b>Grid</b>	1	<b>Frame</b>	Yes
-------------	---	--------------	-----

## Electrical Connection



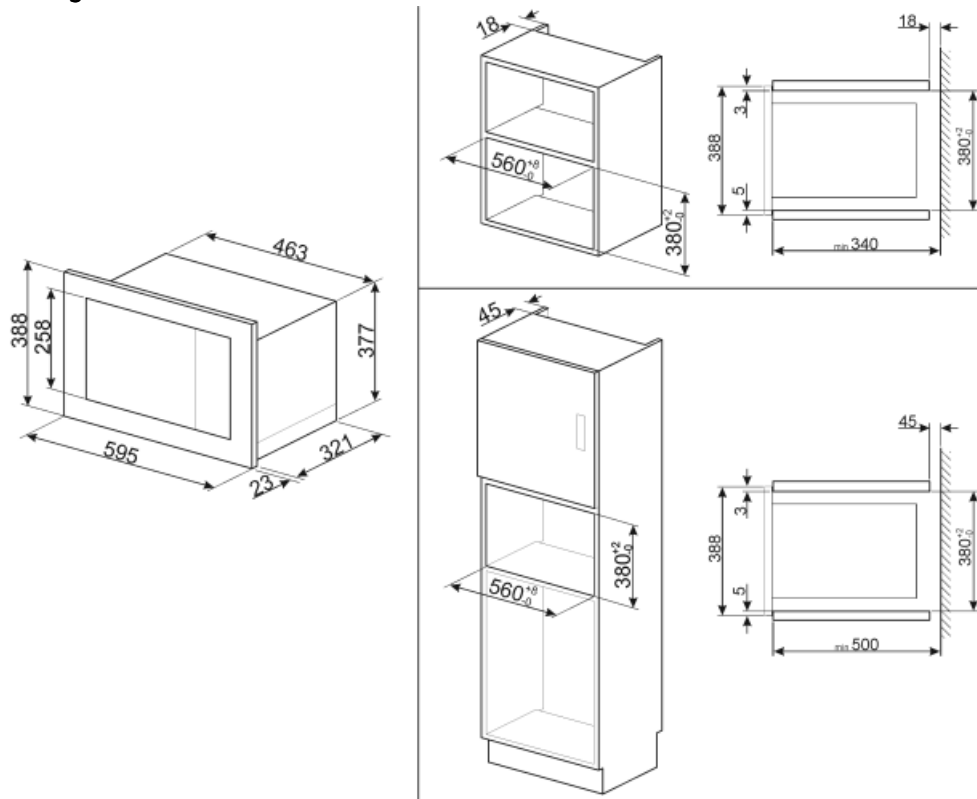







<b>Nominal power</b>	1350 W	<b>Frequency</b>	60 Hz
<b>Current</b>	11 A	<b>Power cord length</b>	59 1/16 "
<b>Voltage</b>	120 V		



---

## Symbols glossary (TT)

---

	Child lock: some models are fitted with a device to lock the programme/cycle so it cannot be accidentally changed.		Microwave energy shortens cooking times dramatically and produces energy savings.
	Defrost by time: with this function the time of thawing of foods are determined automatically.		Defrost by weight: With this function the defrosting time is determined
	Grill element: Using of grill gives excellent results when cooking meat of medium and small portions, especially when combined with a rotisserie (where possible). Also ideal for cooking sausages and bacon.		Microwave: Penetrating straight into the food, microwaves cook very quickly and with considerable energy savings. Suitable for cooking without fat, they are also able to thaw and heat food without altering its original appearance and aroma. The microwave function can also be combined with conventional functions with all the resulting advantages. Ideal for all types of food.
	Microwave + grill element: The use of the grill results in a perfect browning of the surface of the food. The action of microwaves allows instead of cooking in a short time the internal part of the food.		Pizza microwave: This function cooks pizza quicker thanks to the microwaves. To optimize the final result, use the function combined with the Chef plate
	Side lights: Two opposing side lights increase visibility inside the oven.		The capacity indicates the amount of usable space in the oven cavity in litres.