

# ASSEMBLY INSTRUCTIONS

## 24 INCH BATH VANITY (COMBO)

### (INSTRUCTIONS DE MONTAGE MEUBLE-LAVABO DE 24 POUCES (COMBO))

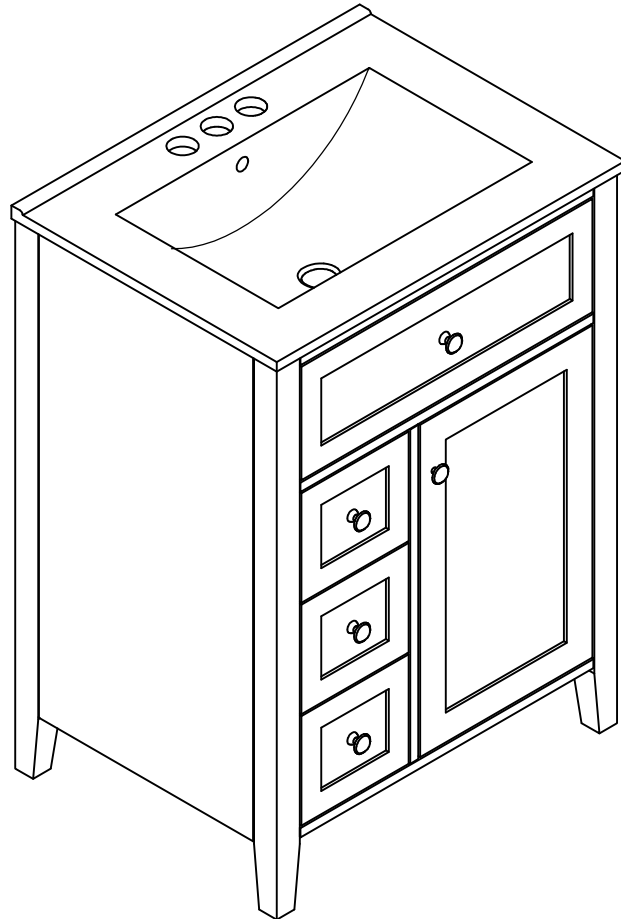

Thank you for purchasing this quality product. Be sure to check all packing material carefully for small parts which may have come loose inside the carton during shipment. Separate, identify and count all parts and hardware.

Compare with the parts list to be sure all parts are present.

**"DO NOT TIGHTEN SCREWS UNTIL COMPLETELY ASSEMBLED"**

Merci d'avoir acheté ce produit de qualité. Assurez-vous de vérifier soigneusement tout le matériel d'emballage pour détecter les petites pièces qui auraient pu se détacher à l'intérieur du carton pendant le transport. Séparez, identifiez et comptez toutes les pièces et le matériel.

Comparez avec la liste des pièces pour vous assurer que toutes les pièces sont présentes.

**"NE SERREZ PAS LES VIS AVANT D'ÊTRE COMPLÈTEMENT ASSEMBLÉES"**

**\* Use of power tool to assemble this product will invalidate any claim and damage this product making unsafe !!!**  
**\* Please assemble on a clean soft surface to avoid damage.**

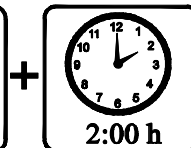
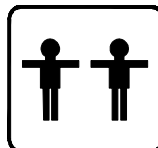
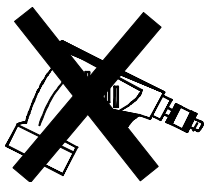

Tools Required

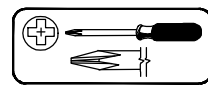

(Not included)

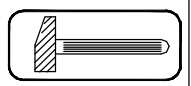

(Not included)

**IMPORTANT:**

**PLEASE READ INSTRUCTION BEFORE STARTING THE ASSEMBLY**  
**VEUILLEZ LIRE LES INSTRUCTIONS AVANT DE COMMENCER L'ASSEMBLAGE**

# Before Installation

**Important - Please read these instructions fully before starting assembly**

Thank you for purchasing this quality product. Be sure to check all packing materials carefully for small parts, which may have come loose inside the carton during shipment. Identify and count all items according to the PARTS LIST and/or HARDWARE LIST shown below. Check you have all the components and tools listed on the following pages.

- . We recommend that you assemble this product with the assistance of another person; this will make the assembly easier, and will help eliminate damage to the product or injury to persons during assembly.
- . Please do not over tighten screws or bolts until the assembly is completed.
- . Keep children and animal away from the work area, small parts could choke if swallowed.
- . Please put all parts on a non-abrasive floor before assembly, and follow the assembly steps to assemble your newly purchased product correctly and efficiently.

**If you find that you have any trouble with assembly or missing or damaged parts please contact the seller.**

## Cam Lock Assembly Instructions

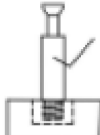
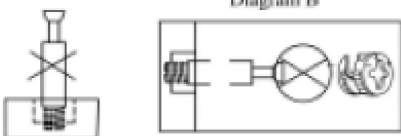
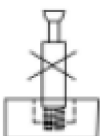
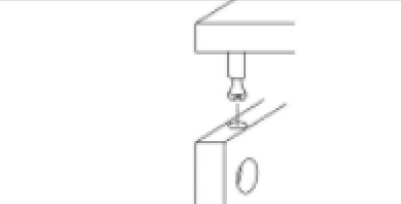
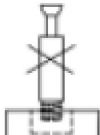
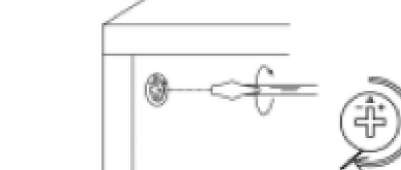
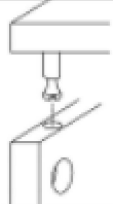
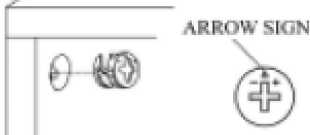
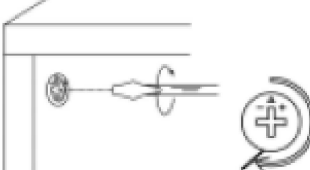
		Diagram A Insert Cam Bolt into hole as shown in diagram A.
		Diagram B Make sure not to insert the Cam Bolt: Too deep as shown in figure B as this will cause the Cam Lock to be misaligned and unable to interlock properly.
		Diagram C Also avoid inserting the Cam Bolt too close to the surface of the hole as shown in figure C, as this will cause the Cam Lock to be too loose, and not interlock properly.
		Connect the panels together.
		ARROW SIGN Insert the Cam Lock so the side opening fits over the head of the Cam Bolt.
		To tighten the Cam Lock, turn it clockwise on half a turn with a flat screwdriver. <i>*Do not use an automatic screwdriver as it may bend or break if too much power is imposed.</i>

# Avant l'installation

**Important - Veuillez lire entièrement ces instructions avant de commencer l'assemblage.**

Merci d'avoir acheté ce produit de qualité. Assurez-vous de vérifier soigneusement tous les matériaux d'emballage pour détecter les petites pièces qui pourraient s'être détachées à l'intérieur du carton pendant le transport. Identifiez et comptez tous les éléments conformément à la LISTE DES PIÈCES et/ou à la LISTE DU MATÉRIEL indiquée ci-dessous. Vérifiez que vous disposez de tous les composants et outils répertoriés dans les pages suivantes.

- Nous vous recommandons d'assembler ce produit avec l'aide d'une autre personne ; cela facilitera l'assemblage et aidera à éliminer les dommages au produit ou les blessures corporelles pendant l'assemblage.
- Veuillez ne pas trop serrer les vis ou les boulons jusqu'à ce que l'assemblage soit terminé.
- Tenir les enfants et les animaux éloignés de la zone de travail, les petites pièces pourraient s'étouffer en cas d'ingestion.
- Veuillez placer toutes les pièces sur un sol non abrasif avant l'assemblage et suivre les étapes d'assemblage pour assembler correctement et efficacement votre produit nouvellement acheté.

Si vous constatez des problèmes d'assemblage ou des pièces manquantes ou endommagées, veuillez contacter le vendeur.

## Instructions d'assemblage du verrou à came

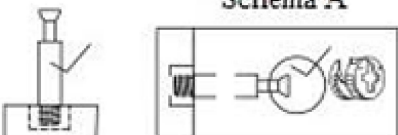
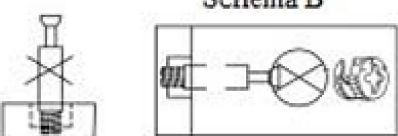
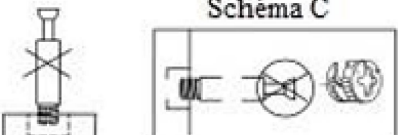
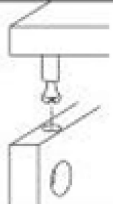
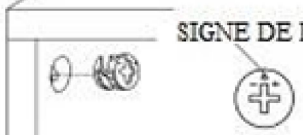
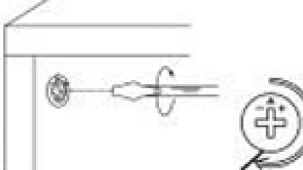

	<p>Schéma A</p> <p>Insérez le boulon à came dans le trou comme indiqué sur le schéma A.</p>
	<p>Schéma B</p> <p>Assurez-vous de ne pas insérer le boulon à came : Trop profond, comme indiqué sur la figure B, car cela entraînerait un mauvais alignement du Cam Lock et son incapacité à se verrouiller correctement.</p>
	<p>Schéma C</p> <p>Évitez également d'insérer le boulon à came trop près de la surface du trou, comme indiqué sur la figure C, car cela rendrait le verrou à came trop lâche et ne s'emboîterait pas correctement.</p>
	<p>Connectez les panneaux ensemble.</p>
	<p>SIGNE DE FLÈCHE</p> <p>Insérez le verrou à came de manière à ce que l'ouverture latérale s'ajuste sur la tête du boulon à came.</p>
	<p>Pour serrer le Cam Lock, tournez-le d'un demi-tour dans le sens des aiguilles d'une montre à l'aide d'un tournevis plat. *N'utilisez pas de tournevis automatique car il pourrait se plier ou se casser si trop de puissance</p>

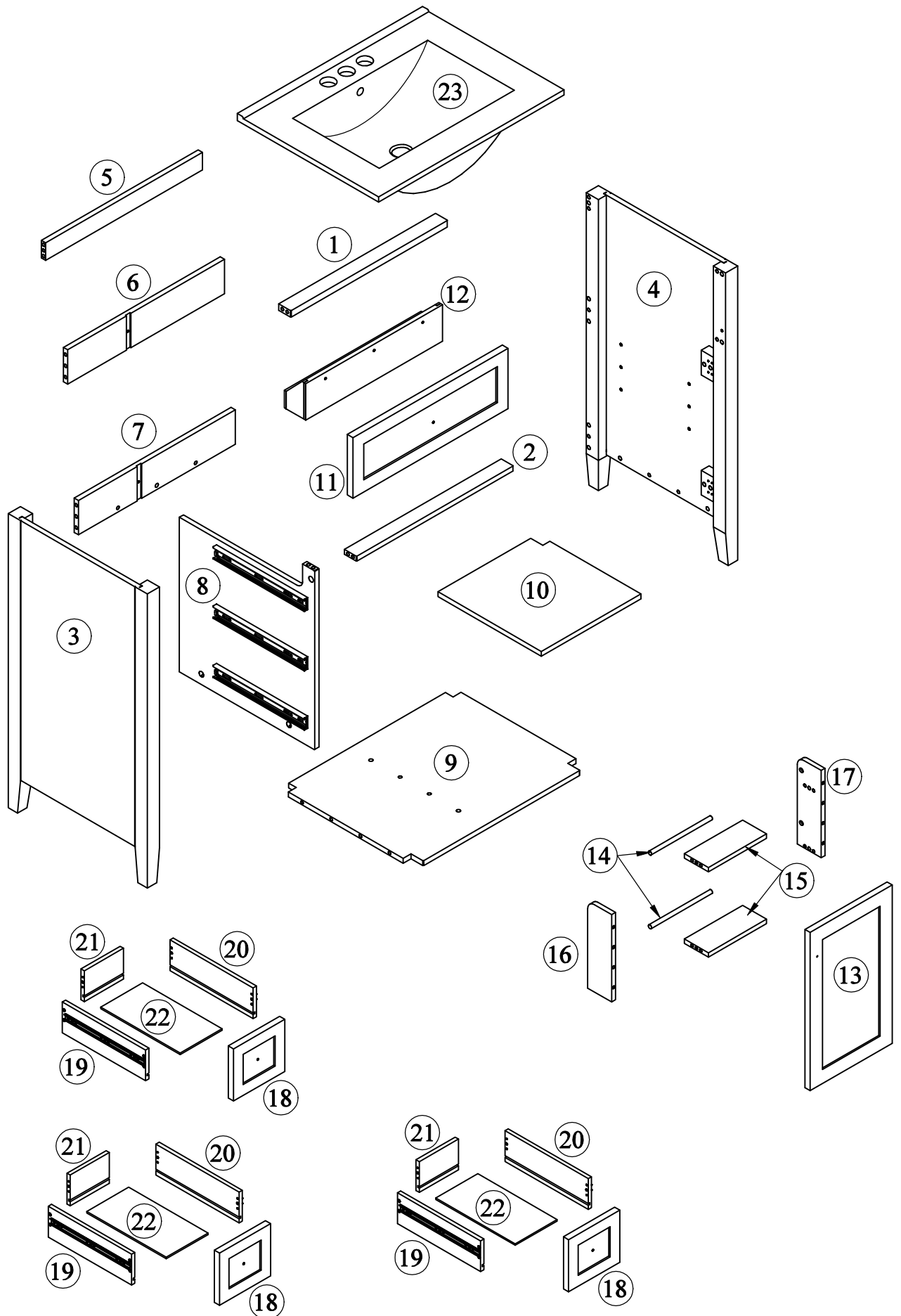
**Detail View - CABINET**  
**(Vue détaillée - ARMOIRE)**





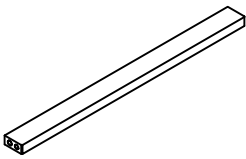
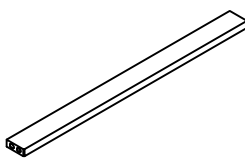
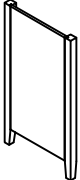
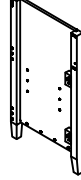
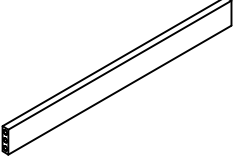
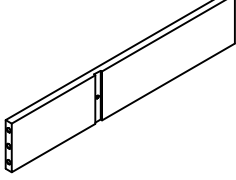
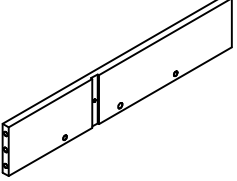
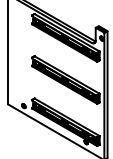
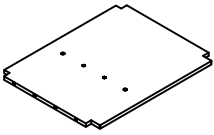

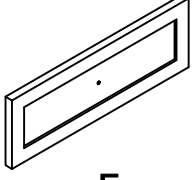
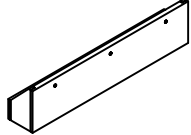
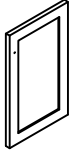
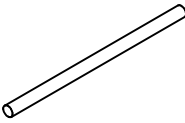
**Identifying the Hardware**-Identify the hardware using the illustrations below.  
 (Identification du matériel - Identification du matériel à l'aide des illustrations ci-dessous)



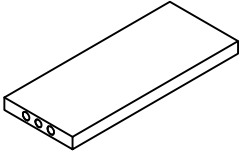

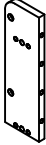
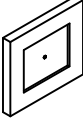
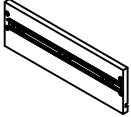
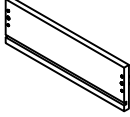

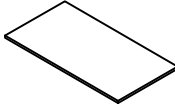
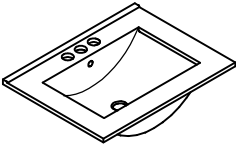

# Part List (Liste des pièces) - N725P280631

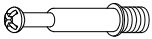
<p><b>1</b></p>  <p><b>Top Bar Front - 1pc</b> (Barre avant supérieure)</p>	<p><b>2</b></p>  <p><b>Bottom Bar Front - 1pc</b> (Barre inférieure avant)</p>
<p><b>3</b></p>  <p><b>Side Panel (L) - 1pc</b> (Côté panneaux)</p>	<p><b>4</b></p>  <p><b>Side Panel (R) - 1pc</b> (Côté panneaux)</p>
<p><b>5</b></p>  <p><b>Top Bar Rear - 1pc</b> Barre supérieure arrière</p>	<p><b>6</b></p>  <p><b>Mid Panel Rear - 1pc</b> (Panneau central arrière)</p>
<p><b>7</b></p>  <p><b>Bottom Panel Rear - 1pc</b> (Arrière panneaux bas)</p>	<p><b>8</b></p>  <p><b>Mid Panel - 1pc</b> (Milieu panneaux)</p>
<p><b>9</b></p>  <p><b>Bottom Panel - 1pc</b> (Panneau inférieur)</p>	<p><b>10</b></p>  <p><b>Adjustable Shelf - 1pc</b> (Étagère réglable)</p>
<p><b>11</b></p>  <p><b>Flip Drawer Face - 1pc</b> (Façade de tiroir rabattable)</p>	<p><b>12</b></p>  <p><b>Flip Drawer - 1pc</b> (Tiroir à charnière)</p>
<p><b>13</b></p>  <p><b>Door Cabinet - 1pc</b> (Armoire à portes)</p>	<p><b>14</b></p>  <p><b>Round Bar - 2pcs</b> (Barre ronde)</p>

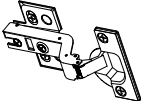
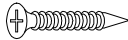
# Part List (Liste des pièces) - N725P280631

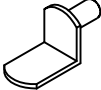
<p><b>15</b></p>  <p><b>Door Mid Panel - 2pcs</b> (Panneau central de porte)</p>	<p><b>16</b></p>  <p><b>Door Side Panel (L) - 1pc</b> (Panneau latéral de porte)</p>
<p><b>17</b></p>  <p><b>Door Side Panel (R) - 1pc</b> (Panneau latéral de porte)</p>	<p><b>18</b></p>  <p><b>Drawer Face - 3pcs</b> (Tiroir devant)</p>
<p><b>19</b></p>  <p><b>Drawer Side Panel (L) - 3pcs</b> (Tiroir côté haut)</p>	<p><b>20</b></p>  <p><b>Drawer Side Panel (R) - 3pcs</b> (Tiroir côté bas)</p>
<p><b>21</b></p>  <p><b>Drawer Back Panel - 3pcs</b> (Tiroir arrière)</p>	<p><b>22</b></p>  <p><b>Bottom Drawer Panel - 3pcs</b> (Tiroir du bas)</p>
<p><b>23</b></p>  <p><b>Sink - 1pc</b> (Lavabo)</p>	

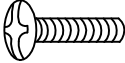
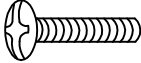
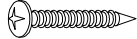
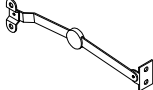
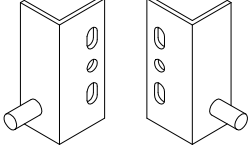
# Hardware List (Liste du matériel) - N725P280631

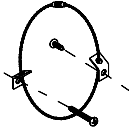
<p><b>A</b></p>  <p>ø6x35mm</p>	<p><b>B</b></p>  <p>ø14.5x12mm</p>	<p><b>C</b></p>  <p>ø8xø4x32mm</p>
<p>Three in one bolts (30pcs) (Boulons trois en un)</p>	<p>Three in one lock (30pcs) (Serrure trois en un)</p>	<p>Round head screw (26pcs) (Vis à tête ronde)</p>
<p><b>D</b></p> 	<p><b>E</b></p>  <p>ø7xø3.5x12mm</p>	<p><b>F</b></p>  <p>ø8x30mm</p>
<p>Damping hinge (2pcs) (Charnière amortissante)</p>	<p>Flat head screw (12pcs) (Vis à tête plate)</p>	<p>Wood dowel (33pcs) (Cheville en bois)</p>
<p><b>G</b></p>  <p>ø6x30mm</p>	<p><b>H</b></p> 	<p><b>I</b></p> 
<p>Wood dowel (12pcs) (Cheville en bois)</p>	<p>Laminate pad (4pcs) (Coussin stratifié)</p>	<p>Handle (5pcs) (Poignées de tiroir)</p>
<p><b>J</b></p>  <p>ø5/32"x22mm</p>	<p><b>K</b></p>  <p>ø5/32"x30mm</p>	<p><b>L</b></p>  <p>ø8xø4x19mm</p>
<p>Handle screw (1pc) (Vis de poignée)</p>	<p>Handle screw (4pcs) (Vis de poignée)</p>	<p>Round head screw (2pcs) (Vis à tête ronde)</p>
<p><b>M</b></p> 	<p><b>N</b></p> 	<p><b>O</b></p>  <p>ø6xø3x12mm</p>
<p>Hinge (1pc) Charnière</p>	<p>Rotary Hinge (2pcs) Charnière rotative</p>	<p>Round head screw (8pcs) (Vis à tête ronde)</p>
<p><b>P</b></p>  <p>Anti fall hardware (2sets) (Quincaillerie anti-chute)</p>		

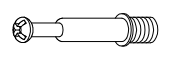

**STEP: 1**  
**(ÉTAPE: 1)**

**A**



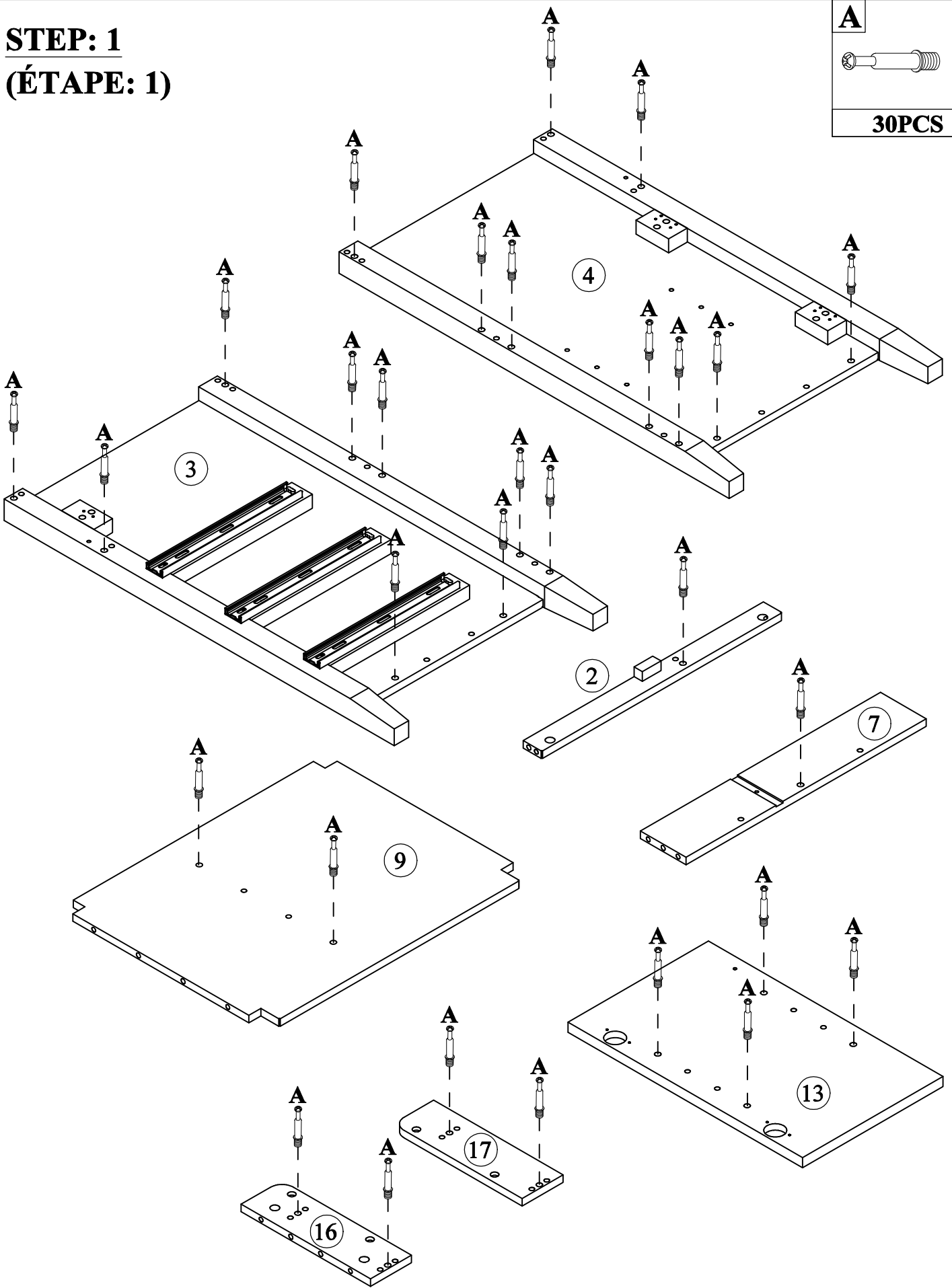

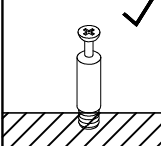
**30PCS**

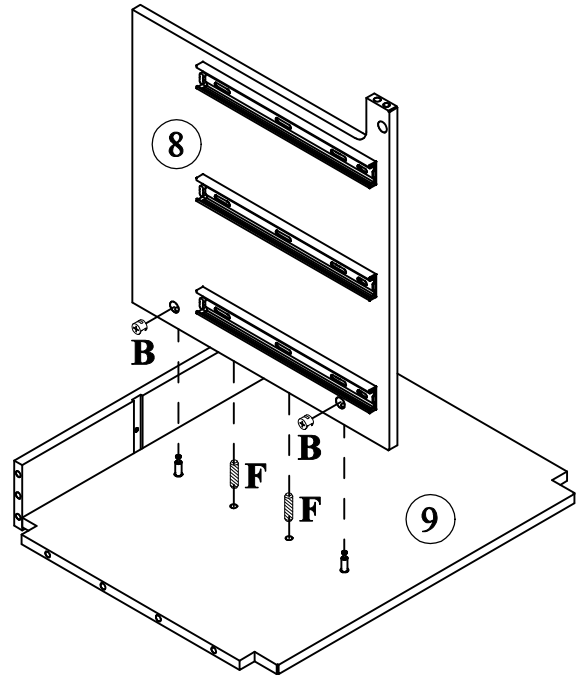
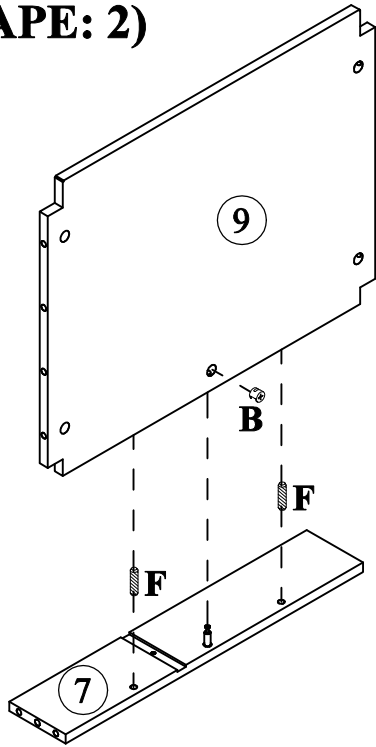

			
--	---	---	---

**STEP: 2**  
**(ÉTAPE: 2)**



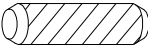

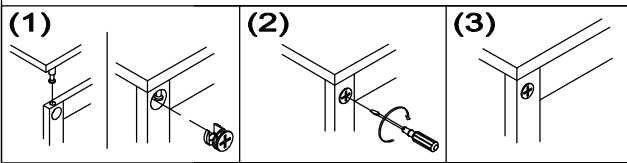
<b>B</b>		<b>F</b>	
<b>3PCS</b>		<b>4PCS</b>	



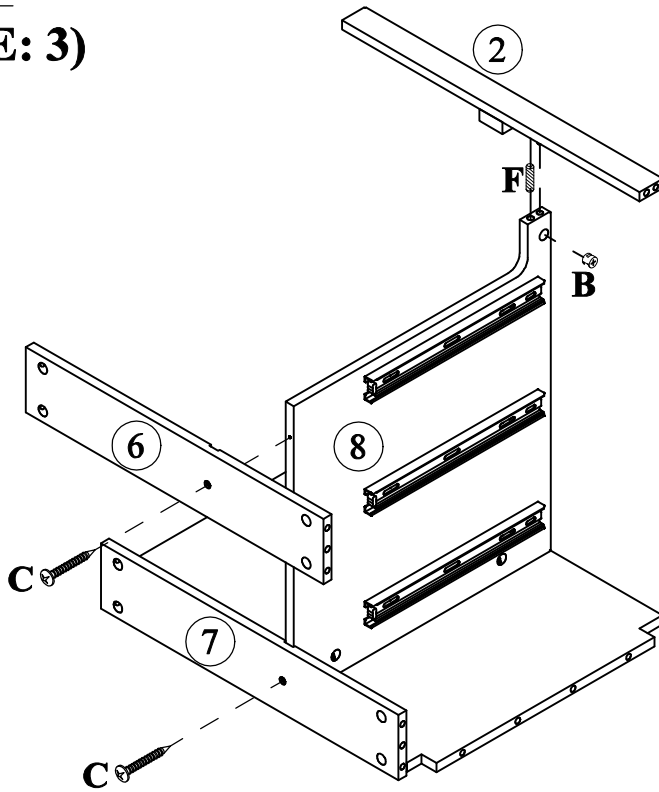

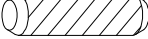

**STEP: 3**  
**(ÉTAPE: 3)**

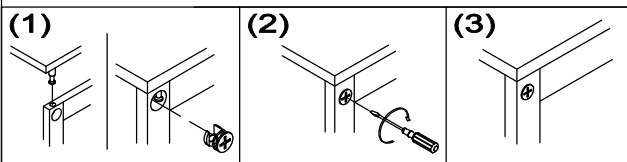

<b>B</b>		<b>C</b>		<b>F</b>	
<b>1PC</b>		<b>2PCS</b>		<b>1PC</b>	

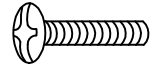

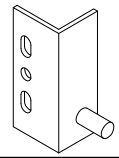
**STEP: 4**  
**(ÉTAPE: 4)**

<b>I</b>	<b>K</b>	<b>L</b>	<b>N</b>	<b>O</b>
				
<b>1PC</b>	<b>1PC</b>	<b>2PCS</b>	<b>2PCS</b>	<b>4PCS</b>

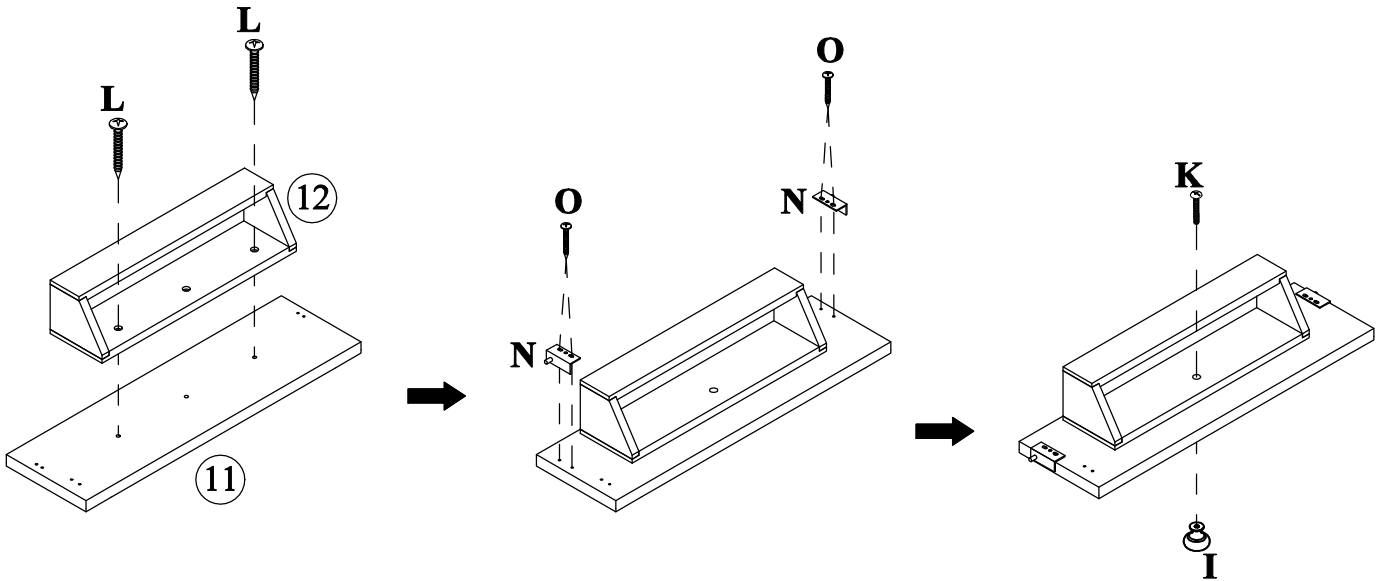

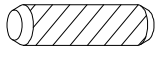

**STEP: 5**  
**(ÉTAPE: 5)**

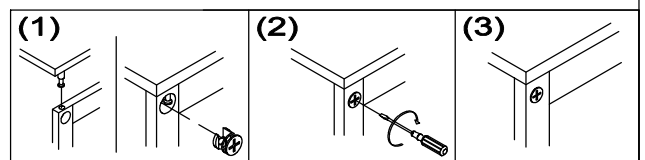
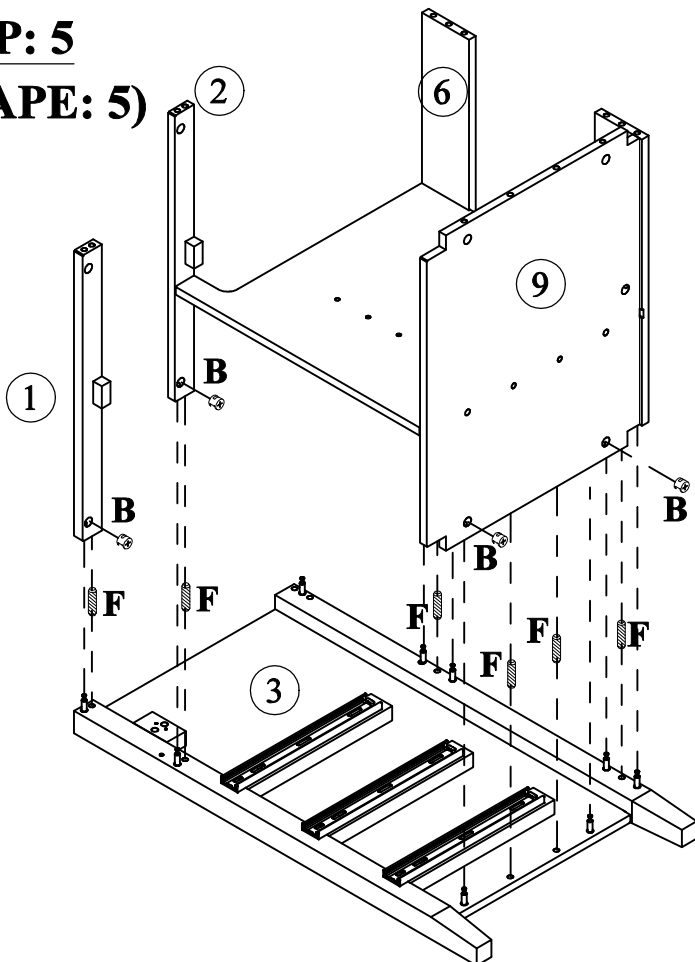
<b>B</b>	<b>F</b>
	
<b>4PCS</b>	<b>6PCS</b>



**STEP: 6**  
**(ÉTAPE: 6)**

<b>B</b>		<b>F</b>	
<b>4PCS</b>		<b>10PCS</b>	

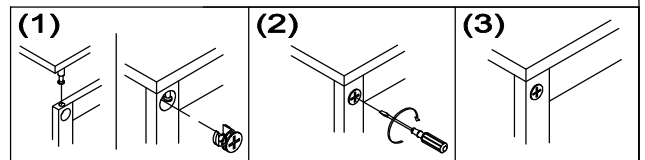
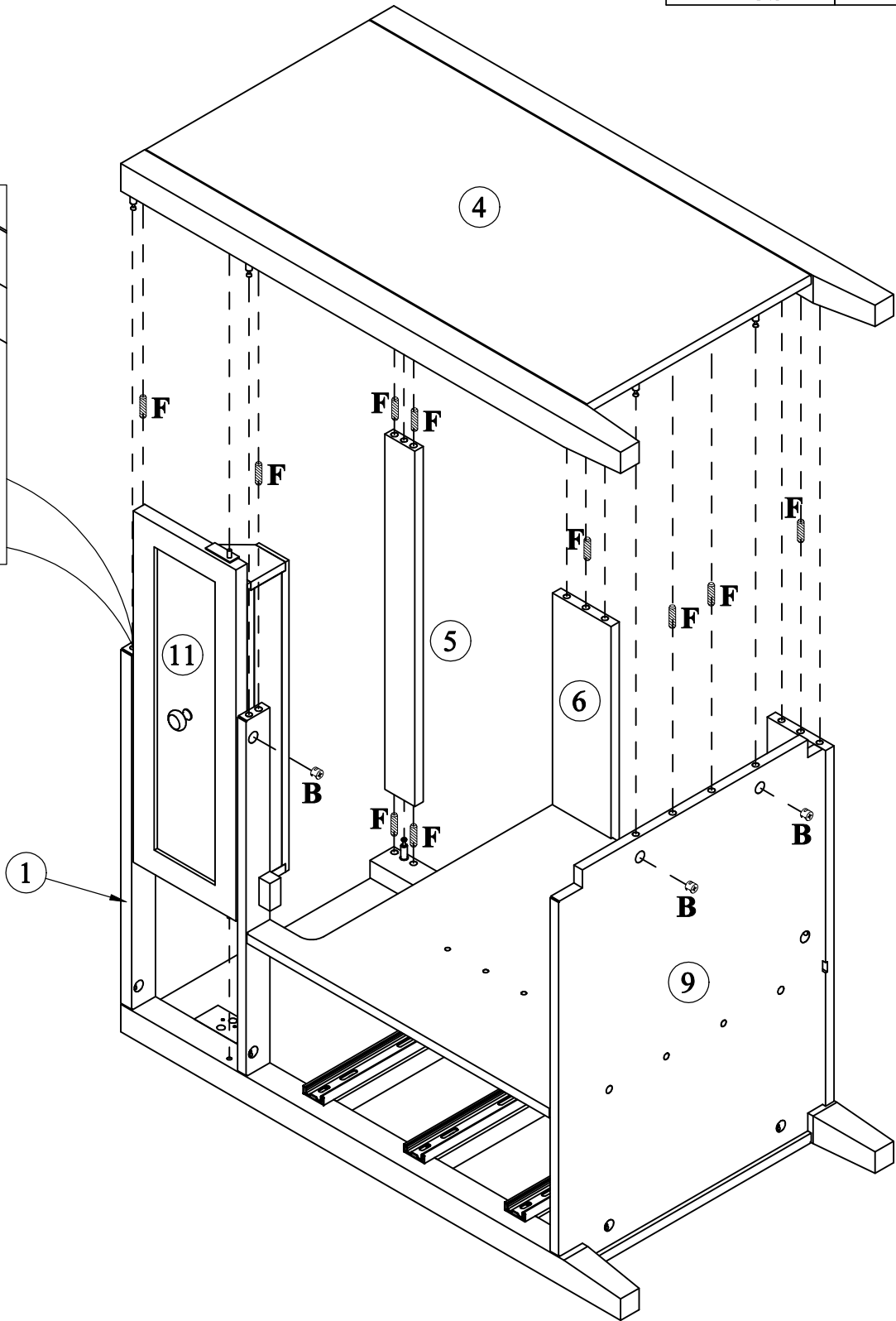
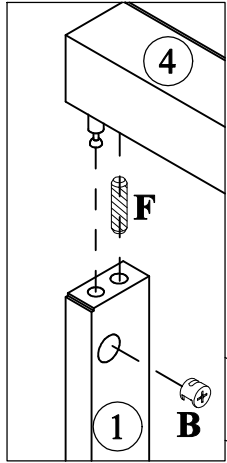

**STEP: 7**  
**(ÉTAPE: 7)**

**B**



**10PCS**

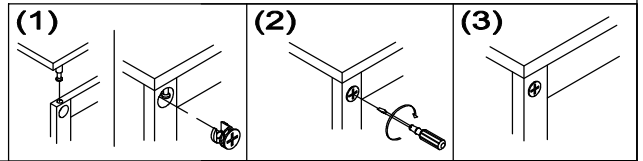
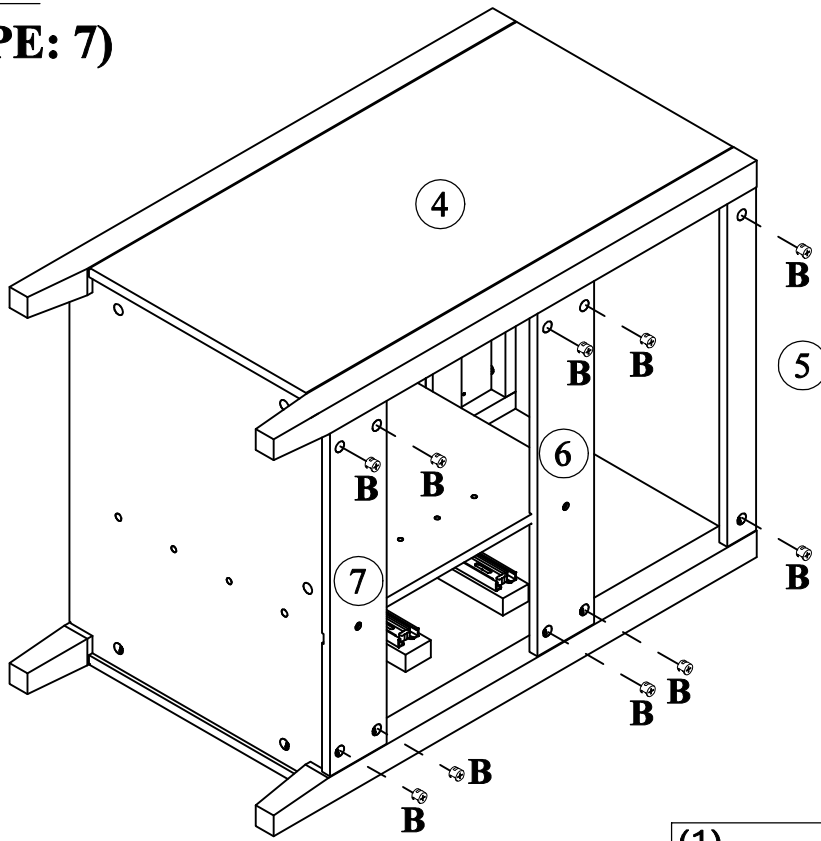

**STEP: 8**  
**(ÉTAPE: 8)**

**M**      **O**

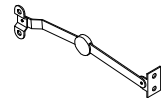

**1PC**

**4PCS**

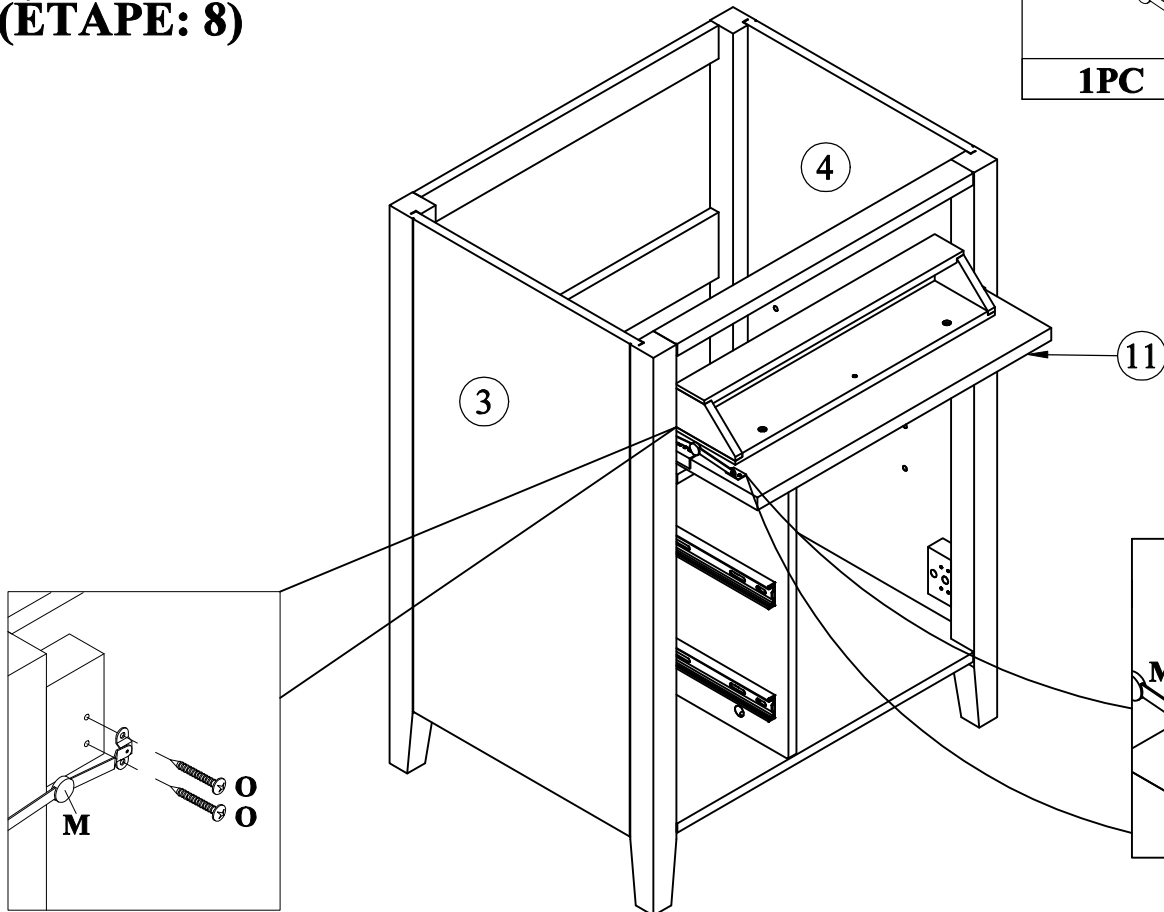

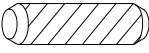

**STEP: 9**  
**(ÉTAPE: 9)**

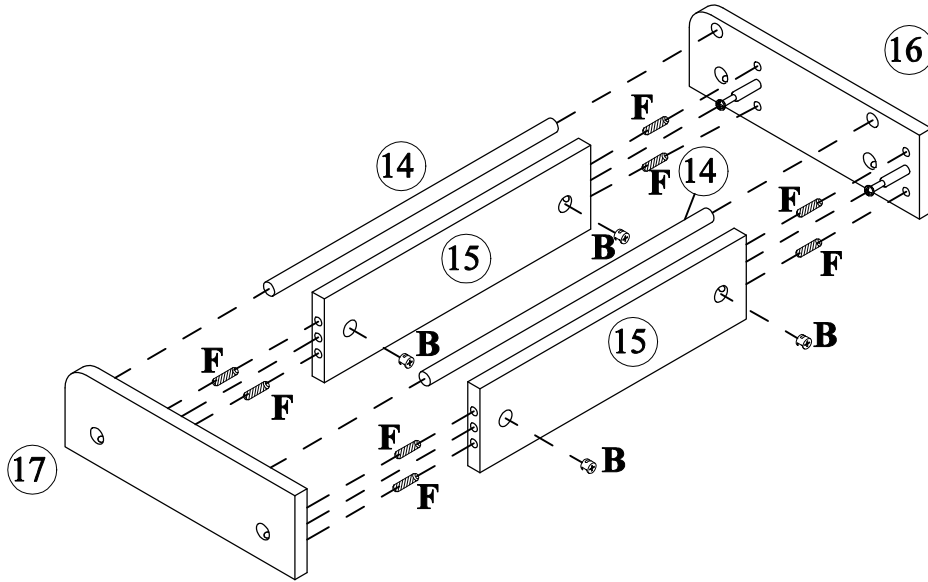
<b>B</b>		<b>F</b>	
	<b>4PCS</b>		<b>8PCS</b>



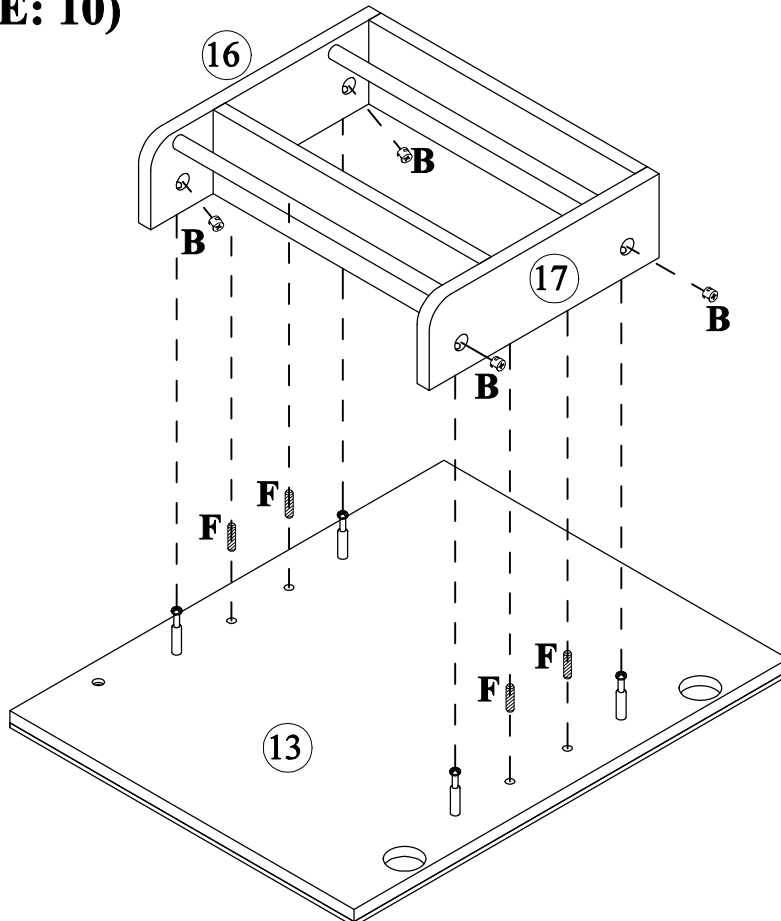

**STEP: 10**  
**(ÉTAPE: 10)**

<b>B</b>		<b>F</b>	
	<b>4PCS</b>		<b>4PCS</b>



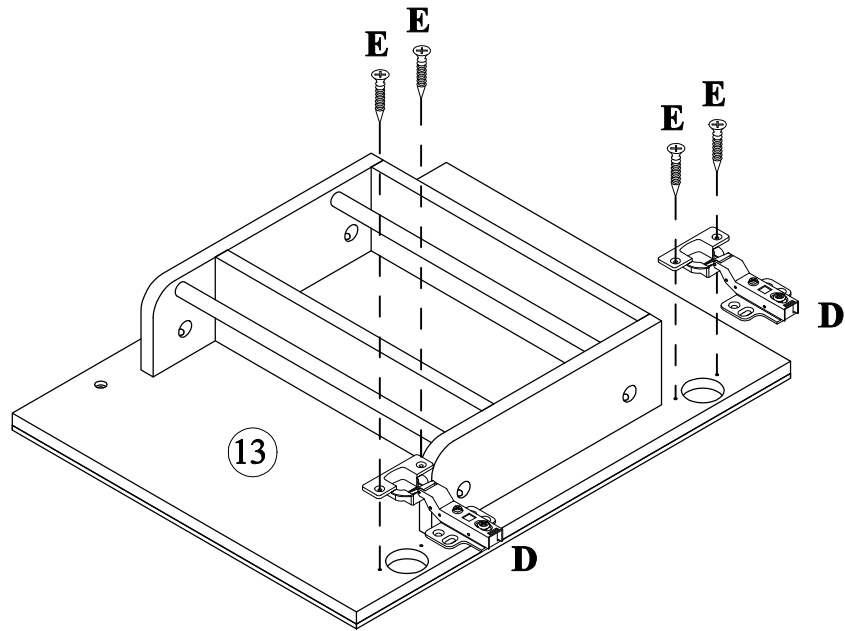

**STEP: 11**  
**(ÉTAPE: 11)**

<b>D</b>	<b>E</b>
	
<b>2PCS</b>	<b>4PCS</b>

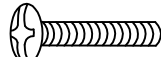

**STEP: 12**  
**(ÉTAPE: 12)**

<b>E</b>	<b>I</b>	<b>J</b>
		
<b>8PCS</b>	<b>1PC</b>	<b>1PC</b>

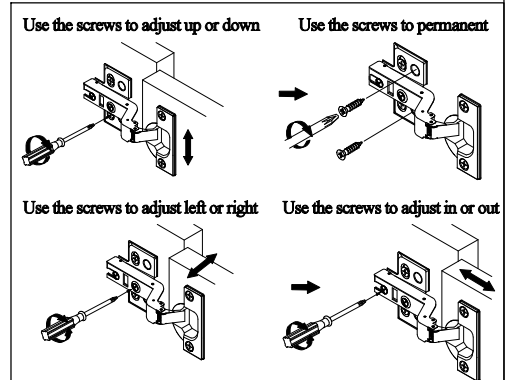
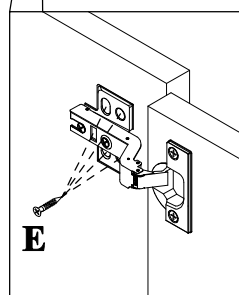
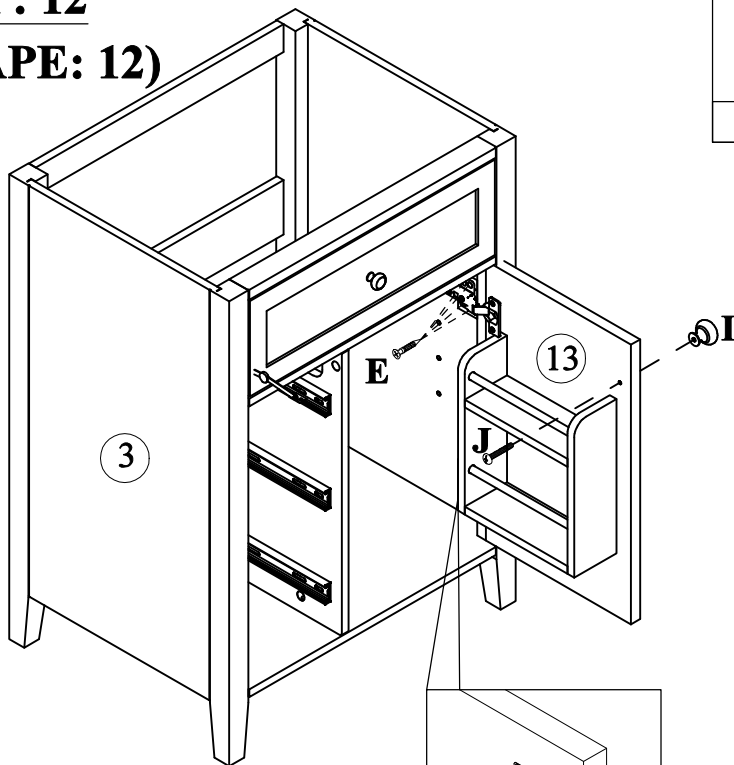

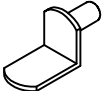

**STEP: 13**  
**(ÉTAPE: 13)**

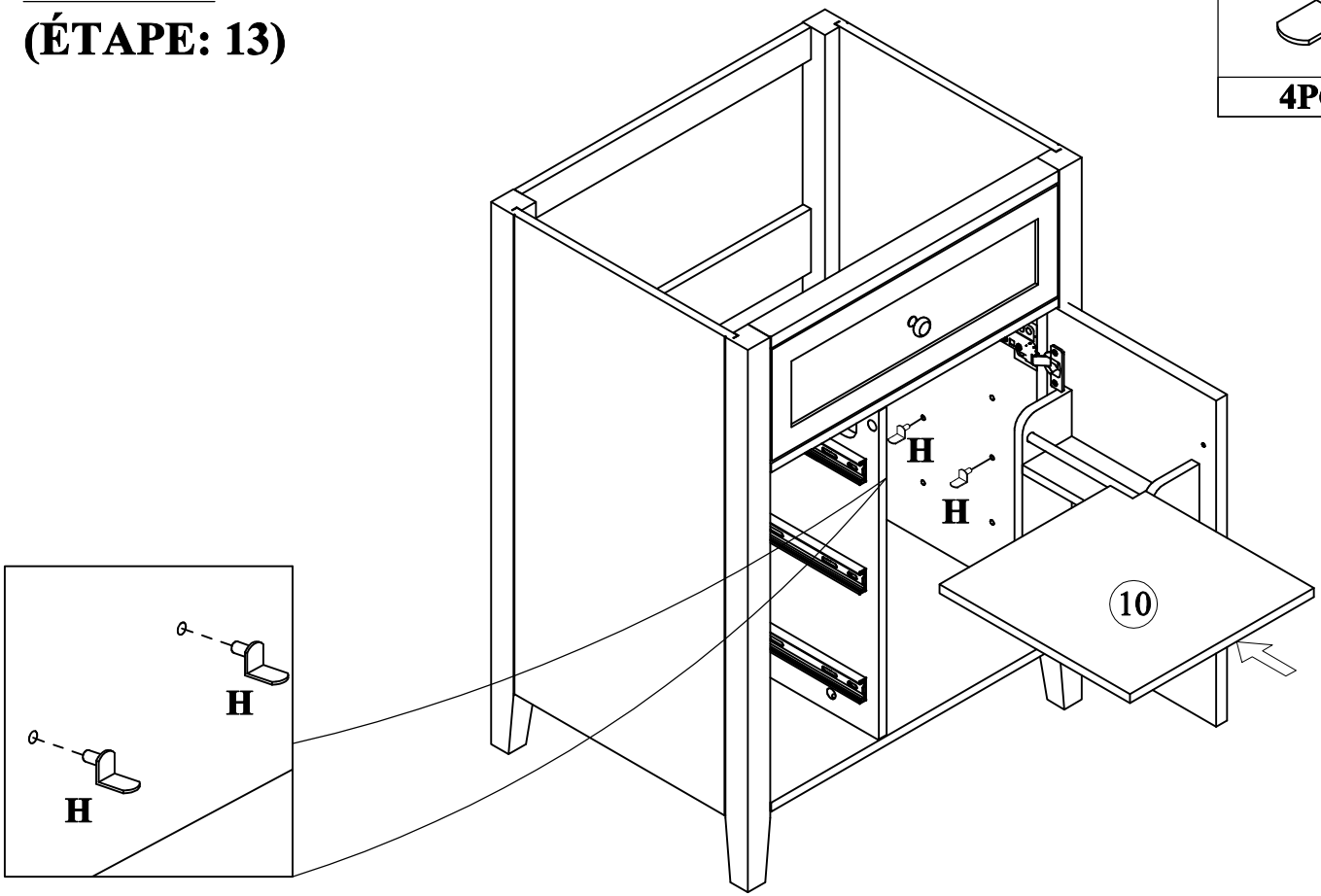
<b>H</b>	
<b>4PCS</b>	

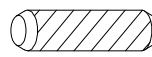

**STEP: 14**  
**(ÉTAPE: 14)**

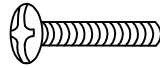
<b>C</b>	<b>G</b>	<b>I</b>	<b>K</b>
			
<b>24PCS</b>	<b>12PCS</b>	<b>3PCS</b>	<b>3PCS</b>

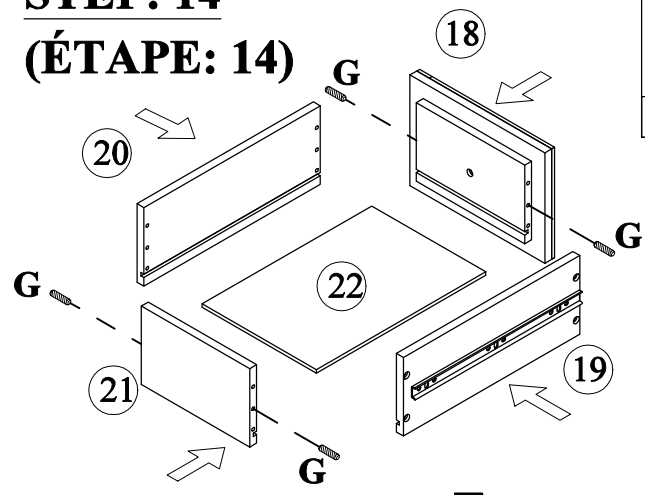

**x3**

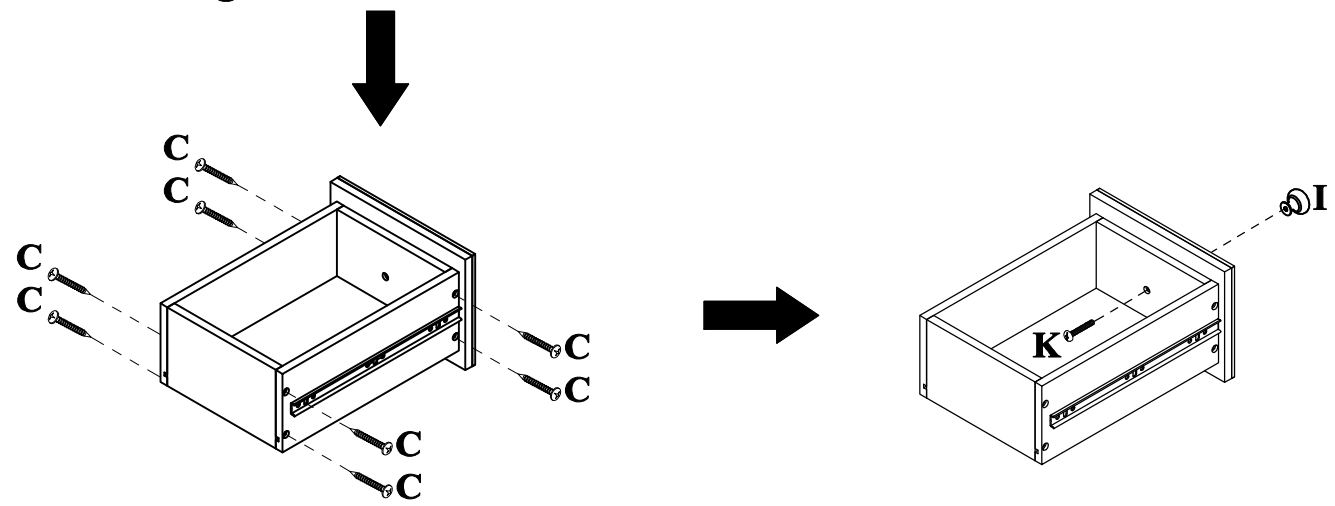

**STEP: 15**  
**(ÉTAPE: 15)**

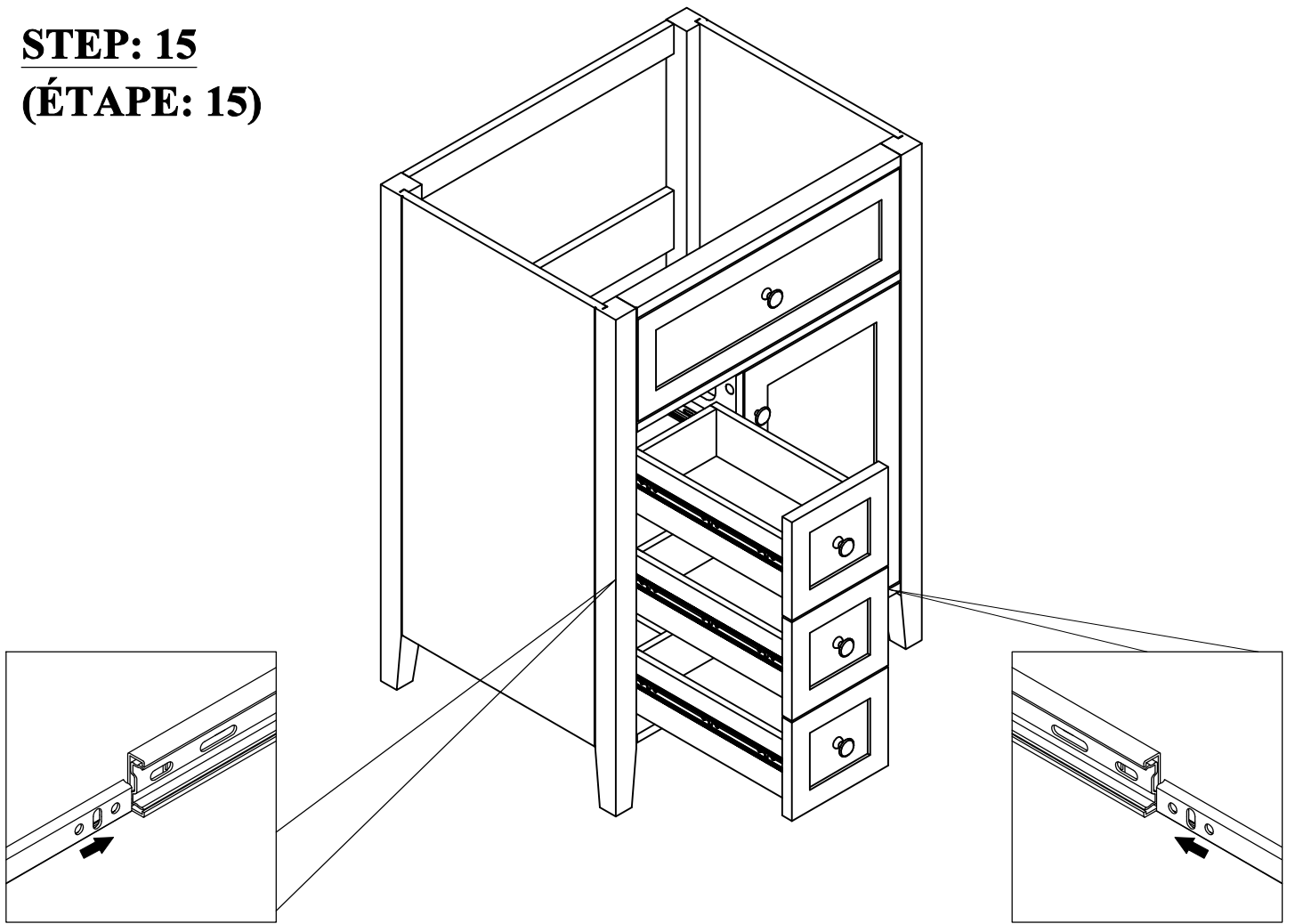

**STEP: 16**  
**(ÉTAPE: 16)**

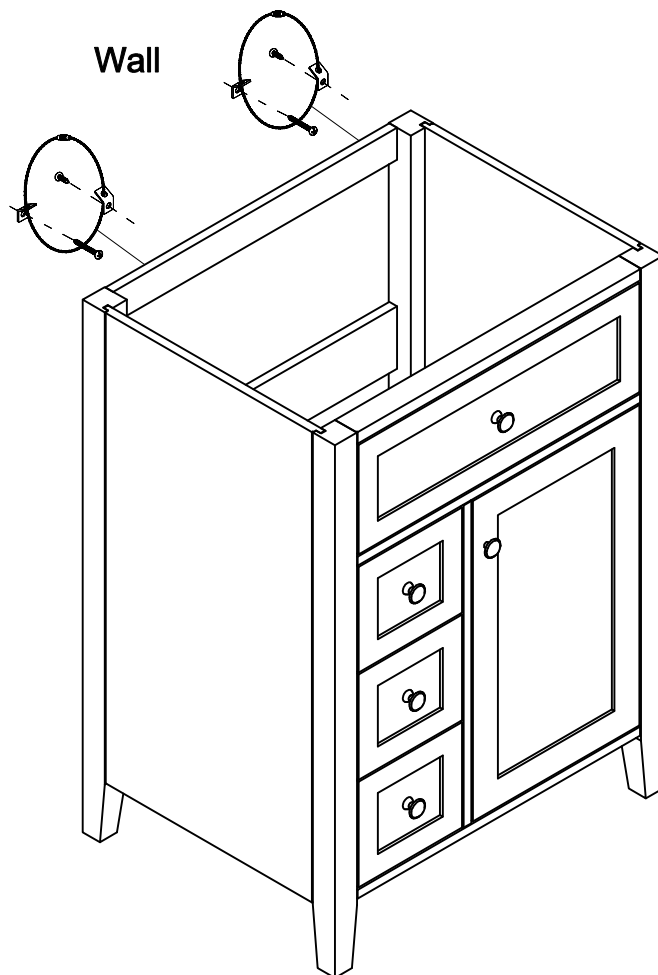

## **STEP: 17**

### **(ÉTAPE: 17)**

Install the sink on the cabinet with glue. Let stand for 24 hours

(Installez l'évier sur le meuble avec de la colle. Laissez reposer 24 heures)

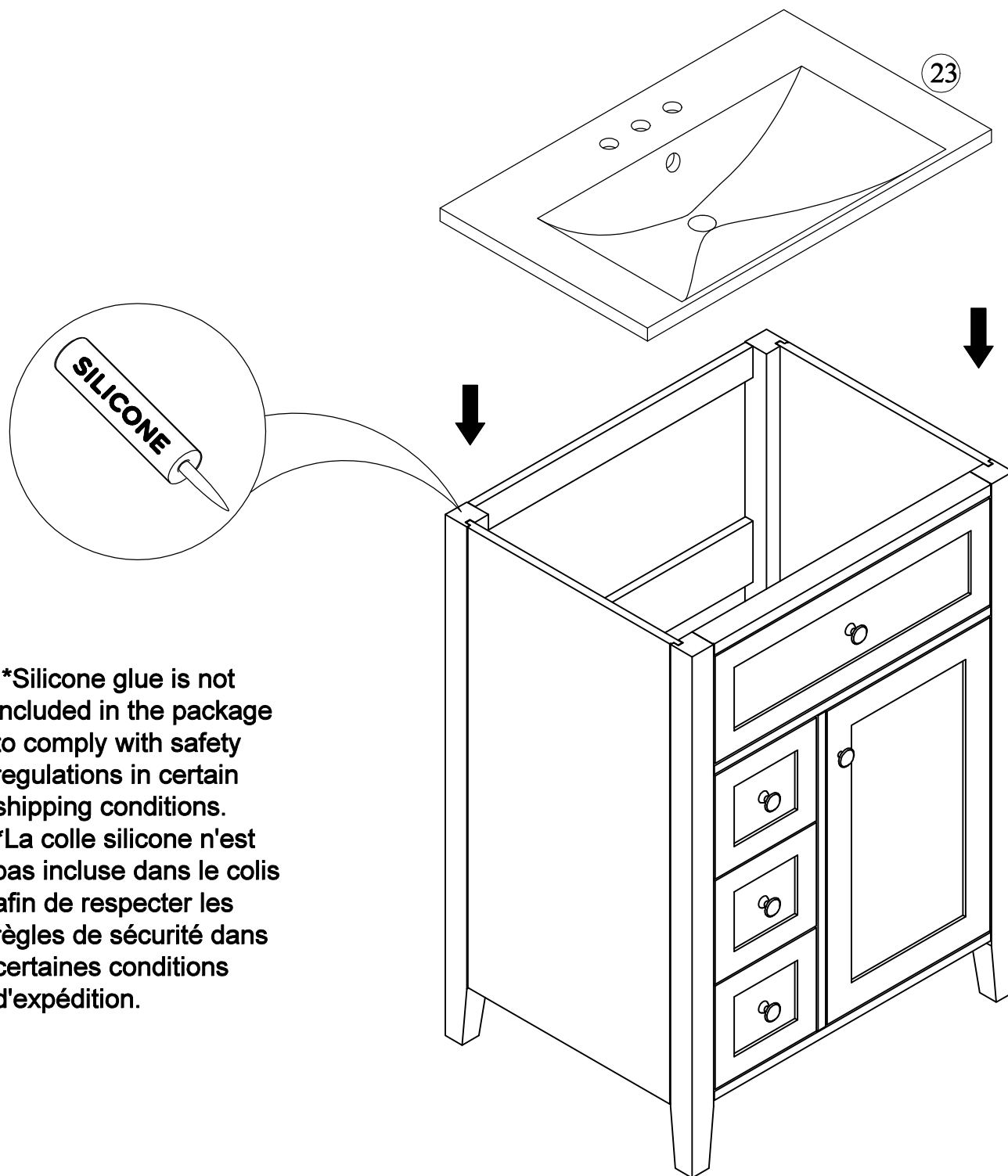

\*Silicone glue is not included in the package to comply with safety regulations in certain shipping conditions.

\*La colle silicone n'est pas incluse dans le colis afin de respecter les règles de sécurité dans certaines conditions d'expédition.

**STEP: 18**  
**(ÉTAPE: 18)**

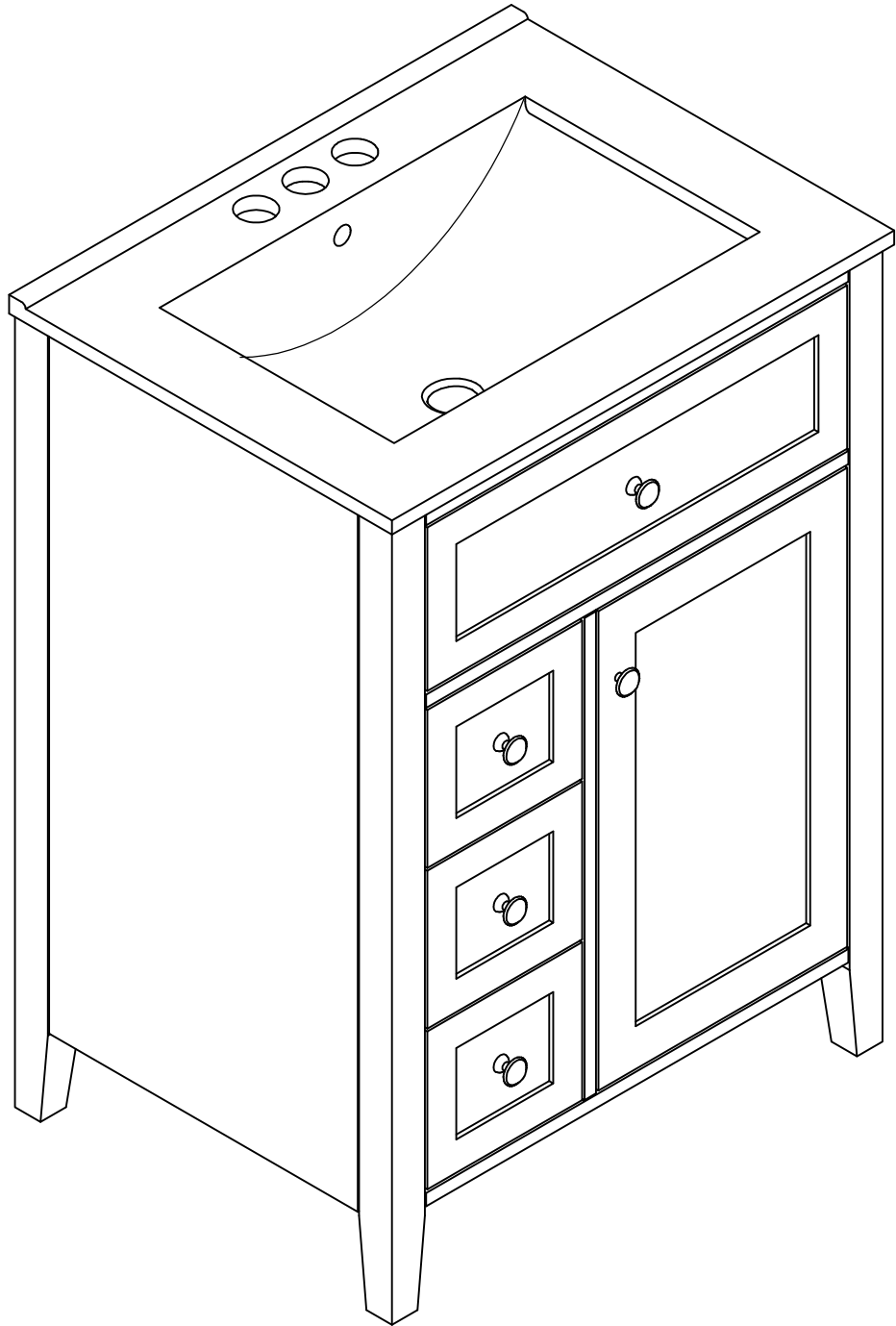

# HINGE ADJUSTMENTS



## 1 Sideways / Tilt adjustment

Turn the screw  
**clockwise** to move the door further away from  
the side of the cabinet  
**anticlockwise** to move the door closer to the  
side of the cabinet

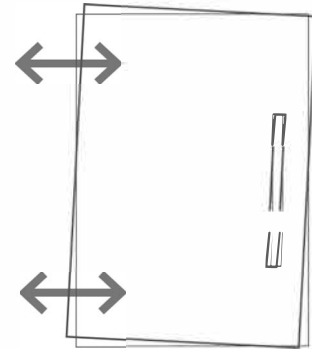

## 2 4 Height adjustment

While supporting the weight of the door, turn the  
screws  
**clockwise** to move the door up  
**anticlockwise** to move the door down

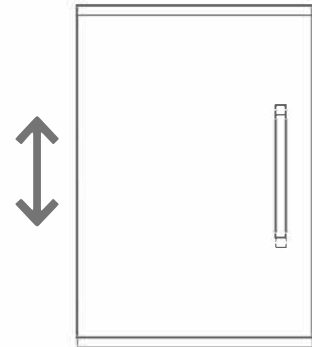

## 3 Forward and back adjustment

If the gap between the back of the door and the  
cabinet is too small, and the door may not close  
fully. Turn the screw  
**clockwise** to decrease the gap between the  
door and the cabinet  
**anticlockwise** to increase the gap between the  
door and the cabinet

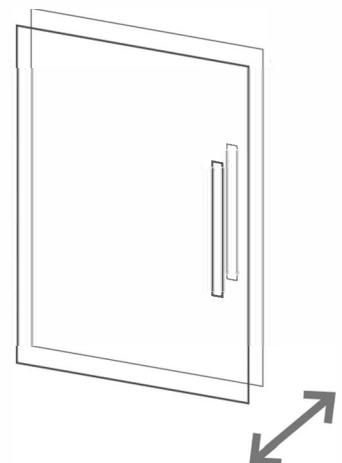

# RÉGLAGES DES CHARNIÈRES

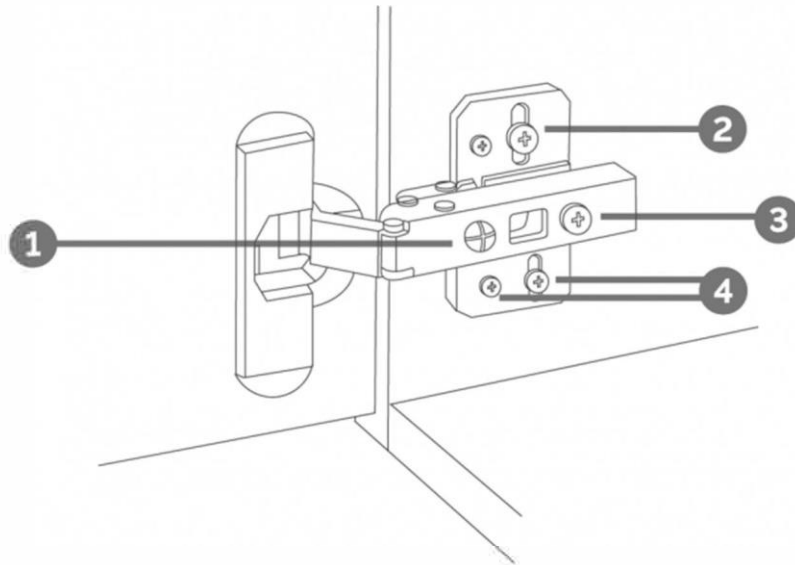

## ❶ De côté / Réglage de l'inclinaison

Tournez la vis dans le sens des aiguilles d'une montre pour éloigner la porte le côté du meuble  
dans le sens inverse des aiguilles d'une montre pour rapprocher la porte du côté du meuble

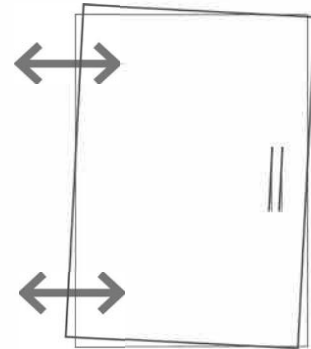

## ❷ ❹ Réglage de la

Tout en supportant le poids de la porte, tournez les vis dans le sens des aiguilles d'une montre pour déplacer la porte vers le haut  
dans le sens inverse des aiguilles d'une montre pour abaisser la porte

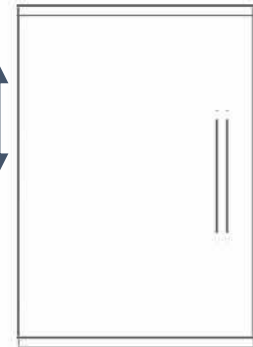

## ❸ Réglage vers l'avant et vers l'arrière

Si l'espace entre l'arrière de la porte et le l'armoire est trop petite et la porte risque de ne pas se fermer complètement. Tournez la vis dans le sens des aiguilles d'une montre pour diminuer l'écart entre la porte et l'armoire  
dans le sens inverse des aiguilles d'une montre pour augmenter l'écart entre la porte et l'armoire.

