

WICKER SOFA SET

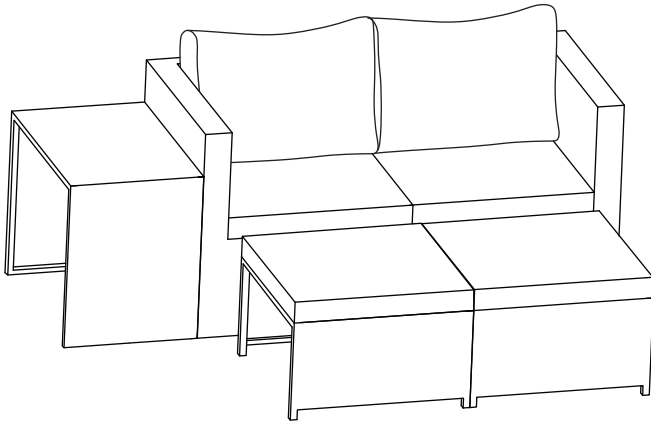

Thank you for choosing Soleil jardin!

Our goal is to provide high quality outdoor furniture with outstanding customer service-all at an affordable price.

Please let us know how we are doing!

Problems?

(Missing pieces, wrong pieces...)

We will fix it immediately. Send us an email

Happy?

Please leave us a review!

You can make others happy too!



**IMPORTANT, RETAIN FOR
FUTURE REFERENCE:
READ CAREFULLY.**

Safety

- For domestic use only.
- Always use on firm level ground.
- Periodic structural checks of this product should be undertaken, do not use if you have any doubts about its fitness for purpose.
- Do not stand on the seat.
- Do not sit on the armrest.
- Do not let children play with this product.
- Maximum load per seat: 250 lbs.

At the beginning of the season

- Check to ensure that all components and fixings of this product are secure, do not use if you have any doubts about its fitness for purpose.

At the end of the season



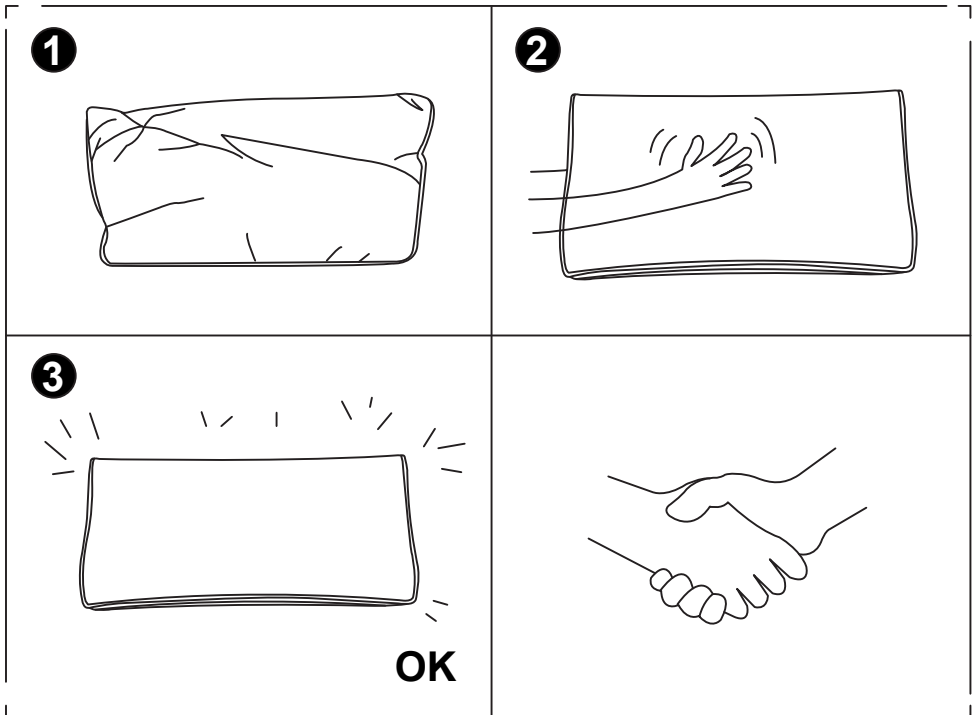

- This product should be stored under cover during prolonged spells of adverse weather (wet or cold) and also during the winter (ideally in a garden shed or garage).
- Always clean and dry thoroughly before storage.

Tips for Cushions

In order to compress the package, we put the cushions in the gap of some parts. So there may be crinkle on the fabric. Don't worry. Just flap every corner of the cushion evenly and it will get back into its original shape soon.

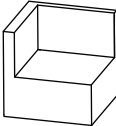
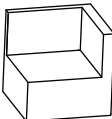
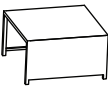

COMPONENT LIST

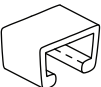
Item no.	Reference Image	Description	Qty.
A		Right Corner Sofa	1
B		Left Corner Sofa	1
C		Ottoman	2
D		Table	1
E		Seat Cushion	4
F		Back Cushion	2
G		Seat Clip	2

NOTE:

Do NOT tighten any screws fully first until you have tightened all the screws.

This may cause the frame to warp.

If there is still wobbles or screw holes cannot be aligned, loosen the screws and tighten sequentially.

If the Sofa Set is not stable it could lead to damage to the product.

1

Pls use Seat Clips (G) to fix the Right Corner Sofa (A) and Left Corner Sofa (B).

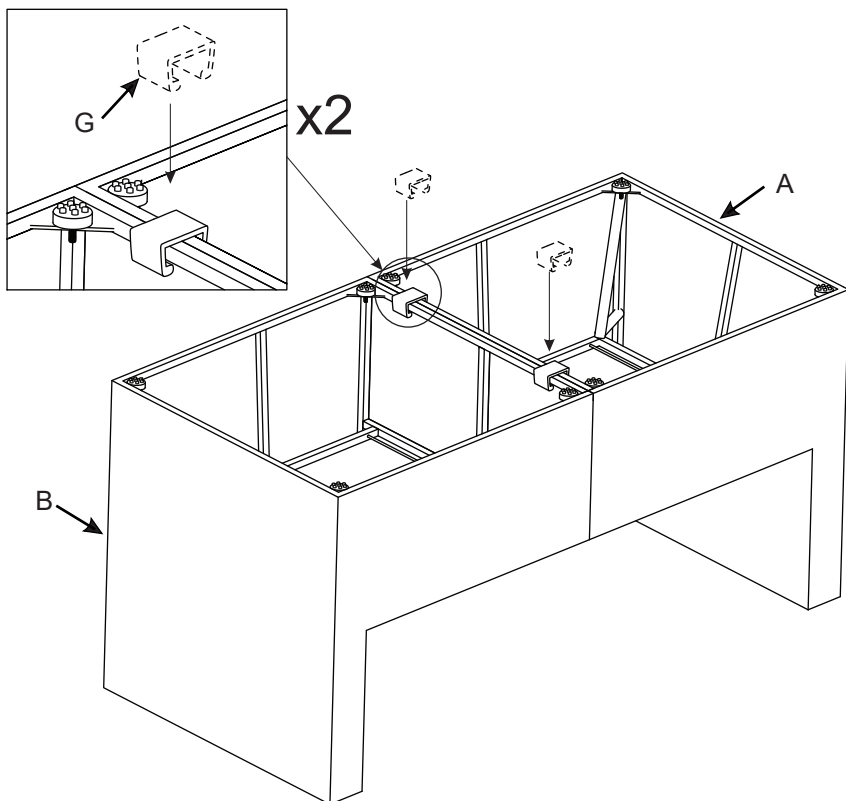

2

Place the sofa set on a level surface, and put Seat Cushions (E) & Back Cushions (F) on the sofa&ottoman. Now your Sofa Set is ready for use.

