

THANKS FOR WATCHING

Your feedback is invaluable to us and we would love to hear about your experience. Please take the time to leave us a review.

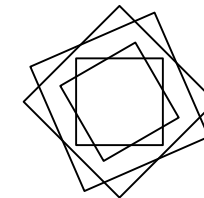

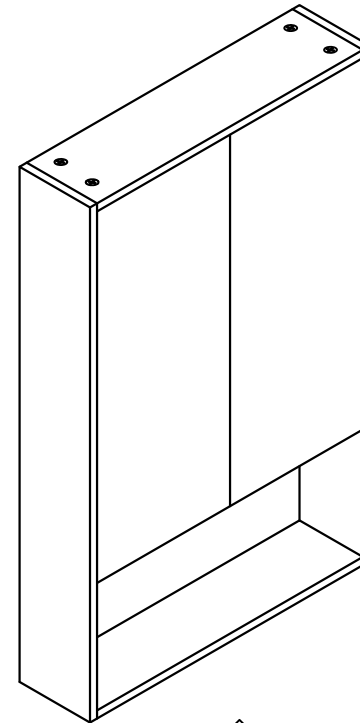











Thank you for shopping with us!

We encourage you to take a few minutes to go through this booklet. It contains important information on installation and care tips to keep your furniture looking as good as new.

Item NO.:BV B120 B24A

Hardware

| NO. | Draw | QTY | NO. | Draw | QTY |
|-----|---|-----|-----|--|-----|
| A |  Screws Ø4 x 14 mm | 24 | G |  Screws for fix on the wall | 4 |
| B |  Two-in-one connector | 24 | H |  Wall hanging screw decorative cover | 4 |
| C |  Two-in-one connector | 24 | I |  Screws Ø4 x 25 mm | 3 |
| D |  Wood plug | 2 | J |  Anti-collision gasket | 2 |
| E |  Plastic anchor(Ø10mm) | 4 | K |  Movable laminate support | 4 |
| F |  Hinges (Internal hiding) | 4 | L |  Screwdriver | 1 |

Recommended tools

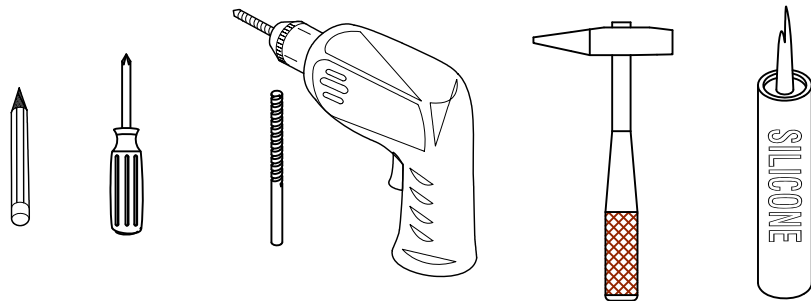

Dimensions

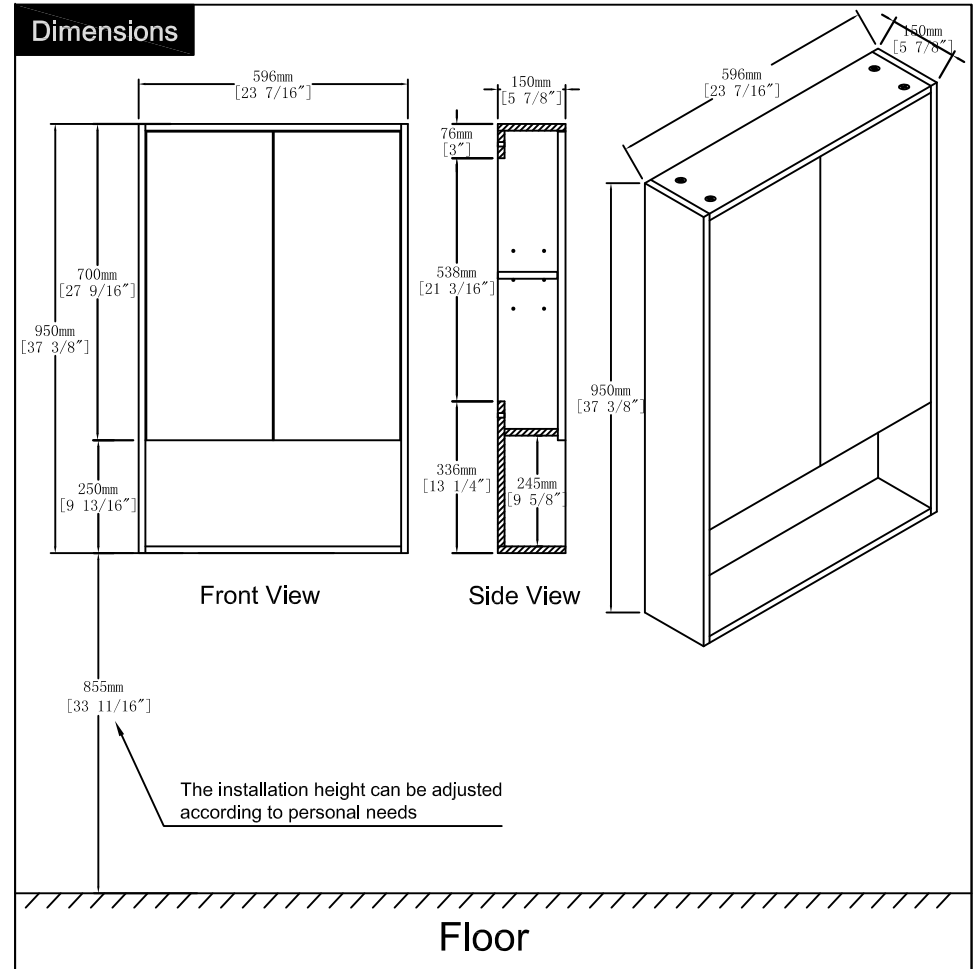



CARE CLEANING AND MAINTENANCE

1. Dust regularly with a soft , dry cloth.
2. Avoid the use of all chemicals household cleaners, abrasives, or cleaners that contain lemon, vinegar, or other acids that may damage the finish.
3. Excessive exposure to sunlight and extreme changes in temperature and moisture can damage wood furniture.
4. Do not place hot appliances, such as curling irons and hot hair dryers directly on the countertop. Wipe spills immediately.

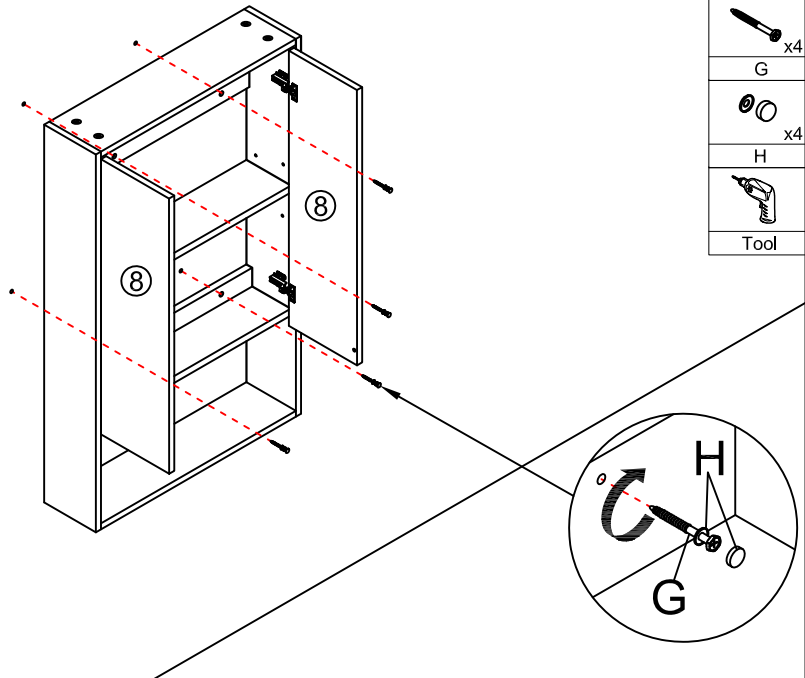
Step 7



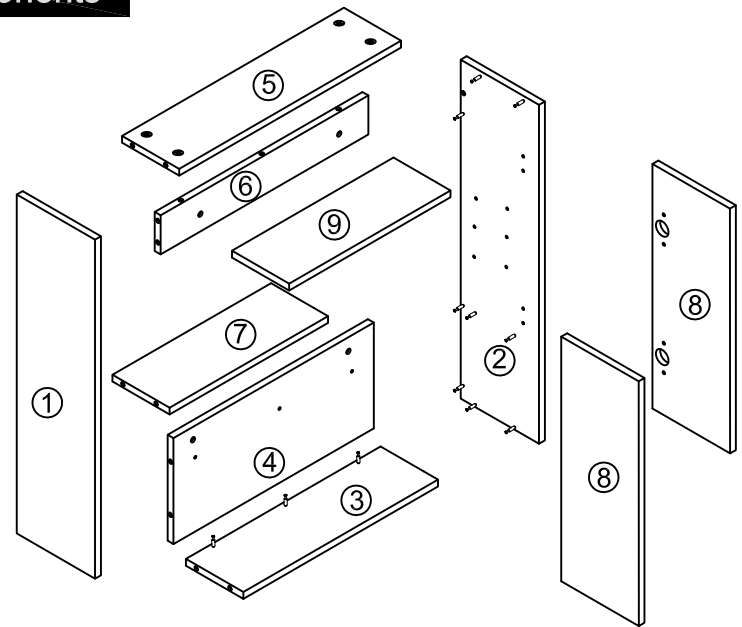

-  x4
- G
-  x4
- H
-  Tool

Components

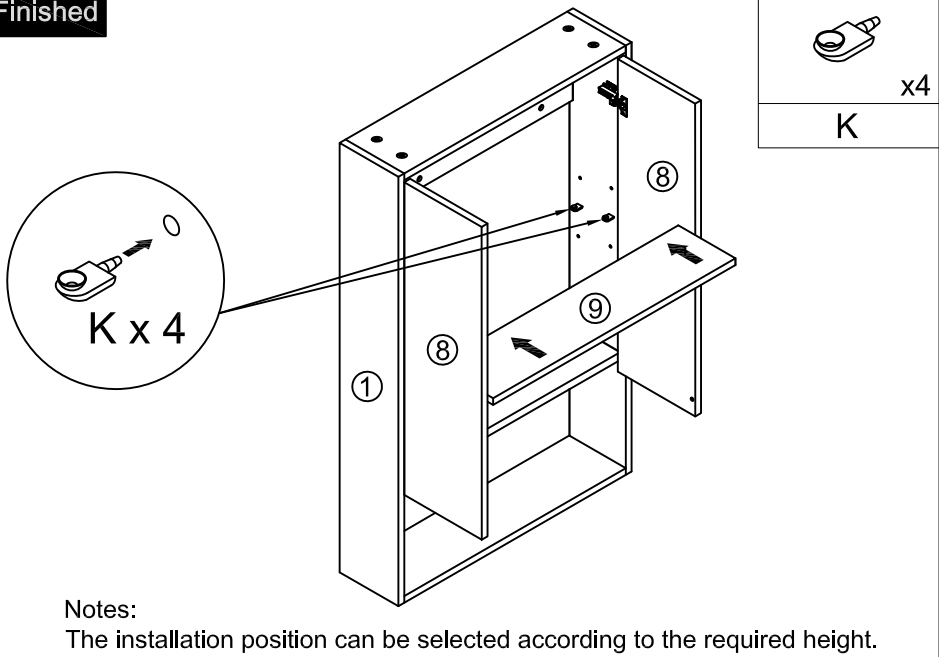

Finished





-  x4
- K

Notes:
The installation position can be selected according to the required height.

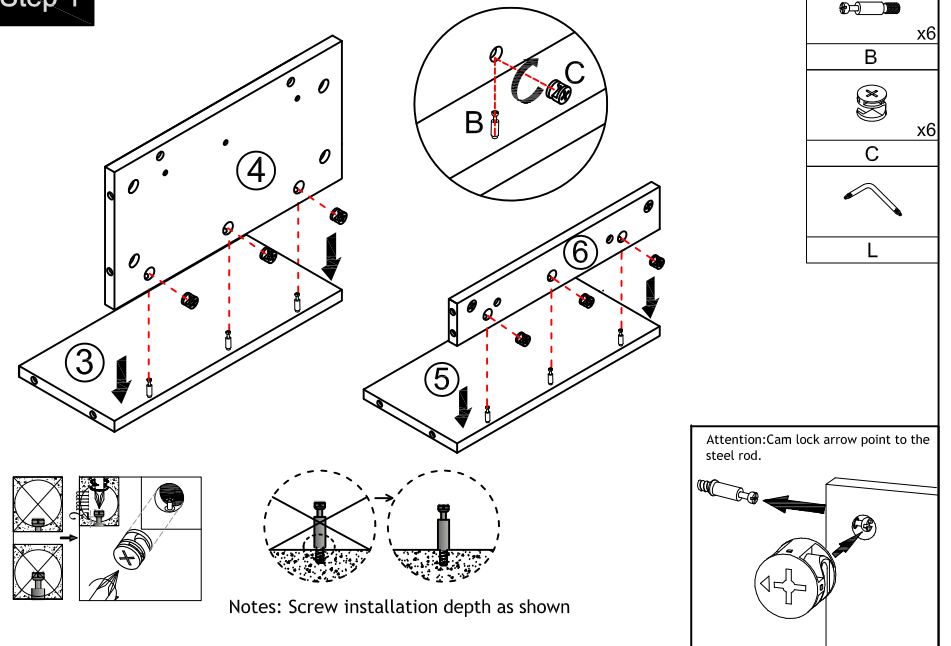
Step 1



-  x6
- B
-  x6
- C
-  L

Notes: Screw installation depth as shown

Attention: Cam lock arrow point to the steel rod.

Step 2

Note: The D parts are used for these this hole

| | |
|--|----|
| | x9 |
| | x9 |
| | x1 |
| | |

Step 4

You can adjust the doors by tightening or loosening the screws on the hinge.

| | |
|--|-----|
| | x24 |
| | x4 |
| | x2 |
| | x2 |
| | |

Step 3

Note: The D parts are used for these this hole

| | |
|--|----|
| | x9 |
| | x9 |
| | x1 |
| | |
| | x3 |
| | |

Step 5

Ø10

Step 6

| | |
|--|----|
| | x4 |
| | |