

# Owner Manual

## NOTICE

---

- \*Please make sure that you have all parts indicated and they are in good condition before you begin assembly of this item. Refer to part list and hardware list below for guidance.
- \*This item should be assembled on a soft surface to prevent scratching the finish during assembly.
- \*This item may require periodic tightening.
- \*If you are having difficulty, our friendly Customer Care team is always here to help.

## PREPARATION

---

- \* Before beginning assembly of product, make sure all parts are present. Compare parts with part contents list and hardware contents list.
- \* If any part is missing or damaged, do not attempt to assemble the product.
- \* Estimated Assembly Time: 10 minutes.
- \* Tools Required for Assembly (included): Allen Key

## CARE AND MAINTENANCE

---

### OUTDOOR FURNITURE CARE

Store outdoor furniture indoors or cover well when not in use. Remove wooden furniture from standing water. Dust regularly with small brush or vacuum. Spills should be taken care of immediately before they harden or stain with a slightly dampened sponge.

### UPHOLSTERY CARE

To prevent overall soiling, frequent vacuuming or light brushing is recommended. Cushions and pillows should be turned on a weekly basis.

Down-filled cushions should be brushed rather than vacuumed. Spot clean, using a mild water-free solvent or dry cleaning product. Only a professional cleaner should undertake a complete overall cleaning.

The use of steam or water-based cleaners may cause excessive shrinking or staining.

Product Dimensions: 76.38" W x 29.52" D x 25.0" H

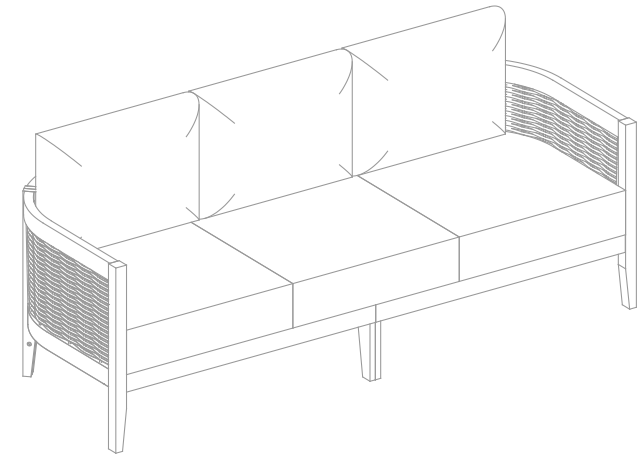









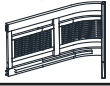

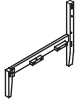





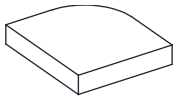
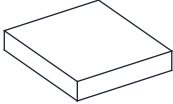
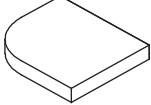

**Weight Capacity : 600 Ibs**

**Warning : Do not stand on bench**

**Warning : Do not over torque bolts / screws**

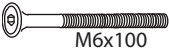
## Part List and Hardware List

| PIECE | DESCRIPTION            | PICTURE   | QUANTITY |
|-------|------------------------|---|----------|
| A     | Left Leg Panel         |    | 1X       |
| B     | Left Backrest Panel    |    | 1X       |
| C     | Left Support Bar       |    | 1X       |
| D     | Left Middle Leg Panel  |    | 1X       |
| E     | Right Leg Panel        |    | 1X       |
| F     | Right Backrest Panel   |    | 1X       |
| G     | Right Support Bar      |    | 1X       |
| H     | Right Middle Leg Panel |    | 1X       |
| I     | Left Seat Panel        |   | 1X       |
| J     | Right Seat Panel       |  | 1X       |

| PIECE | DESCRIPTION               | PICTURE   | QUANTITY |
|-------|---------------------------|---|----------|
| CSH1  | Left Seat Cushion         |          | 1X       |
| CSH2  | Middle Seat cushion       |          | 1X       |
| CSH3  | Right Seat Cushion        |          | 1X       |
| CSH4  | Back Cushion              |          | 3X       |
| HW1   | Allen Bolt: M6x0.5x30 mm  |  M6x30   | 8X       |
| HW2   | Insert Nut                |  M6x15   | 8X       |
| HW3   | Allen Bolt: M6x0.5x45 mm  |  M6x45   | 8X       |
| HW4   | Screws M6x0.5x60 mm       |  M6x60   | 4X       |
| HW5   | Allen Bolt: M6x0.5x100 mm |  M6x100  | 2X       |
| HW6   | Screws M6x0.5x35 mm       |  M6x35   | 4X       |
| HW7   | Screws M6x0.5x45 mm       |  M6x45 | 4X       |
| HW8   | Allen key                 |  LG4   | 2X       |

# PREPARATION

- \*Before beginning assembly of product, make sure all parts are present. Compare parts with package contents list and hardware contents list.
- \*If any part is missing or damaged, do not attempt to assemble the product.
- \* Estimated Assembly Time : 10 minutes.
- \* Tools Required for Assembly (included): Allen Key
- \* If you are having difficulty, our friendly Customer care team is always here to help.

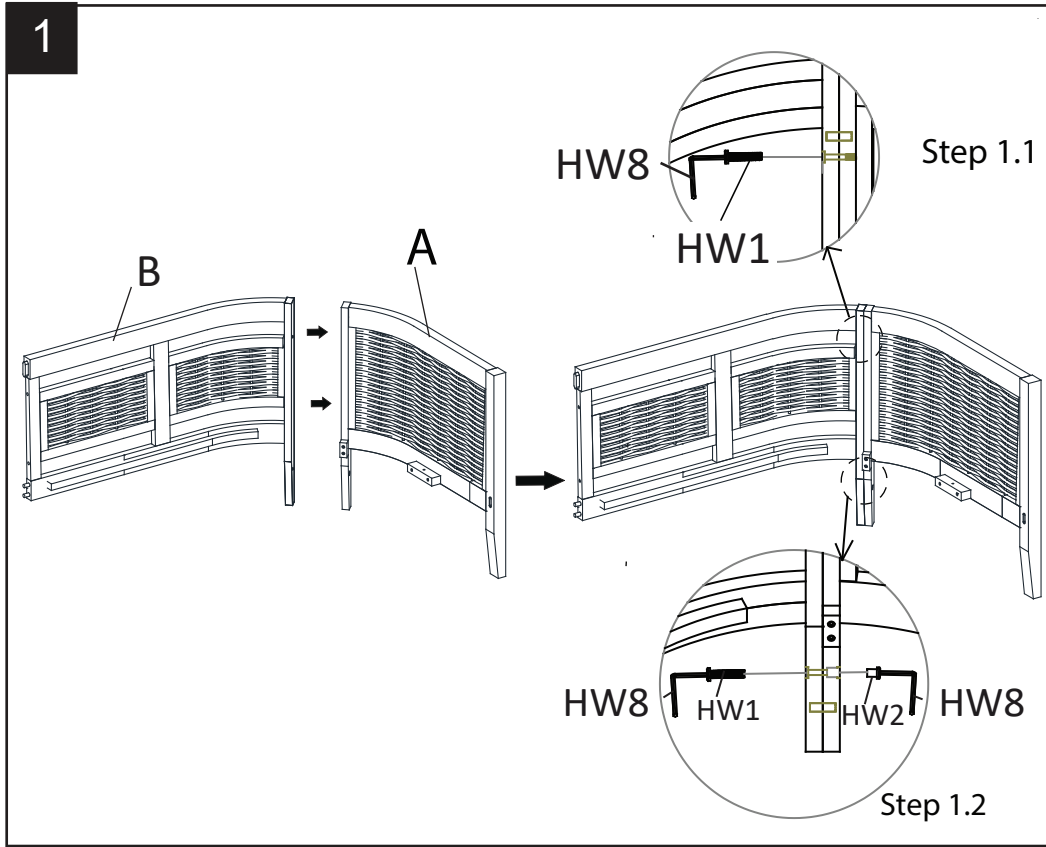
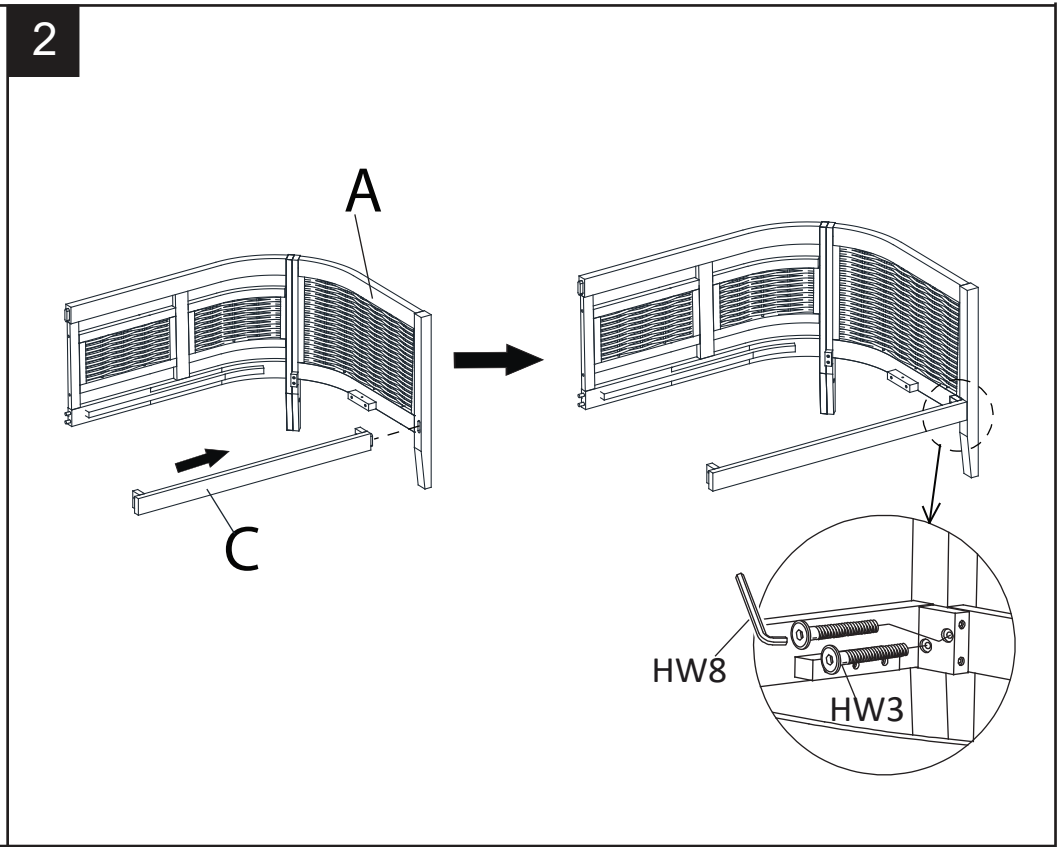
|   |   |
|---|---|
| <p><b>1</b></p>  <p>Step 1.1</p> <p>Step 1.2</p>  | <p><b>2</b></p>  <p>Step 2</p>                |
| <p>Step 1.1<br/>Attach the Left Backrest Panel (B) to the Left leg Panel (A) using Bolts(HW1) and the Allen key (HW8) as shown above.</p> <p>Step 1.2<br/>Attach the Left Backrest Panel (B) to the Left leg Panel (A) using Bolts(HW1), Insert Nuts(HW2) and the Allen key (HW8) as shown above.</p> | <p>Step 2<br/>Attach the Left Support Bar (C) to the Left leg Panel (A) using Bolts(HW3), the Allen key (HW8) as shown above.</p> |

# PREPARATION

- \*Before beginning assembly of product, make sure all parts are present. Compare parts with package contents list and hardware contents list.
- \*If any part is missing or damaged, do not attempt to assemble the product.
- \* Estimated Assembly Time : 10 minutes.
- \* Tools Required for Assembly (included): Allen Key
- \* If you are having difficulty, our friendly Customer care team is always here to help.

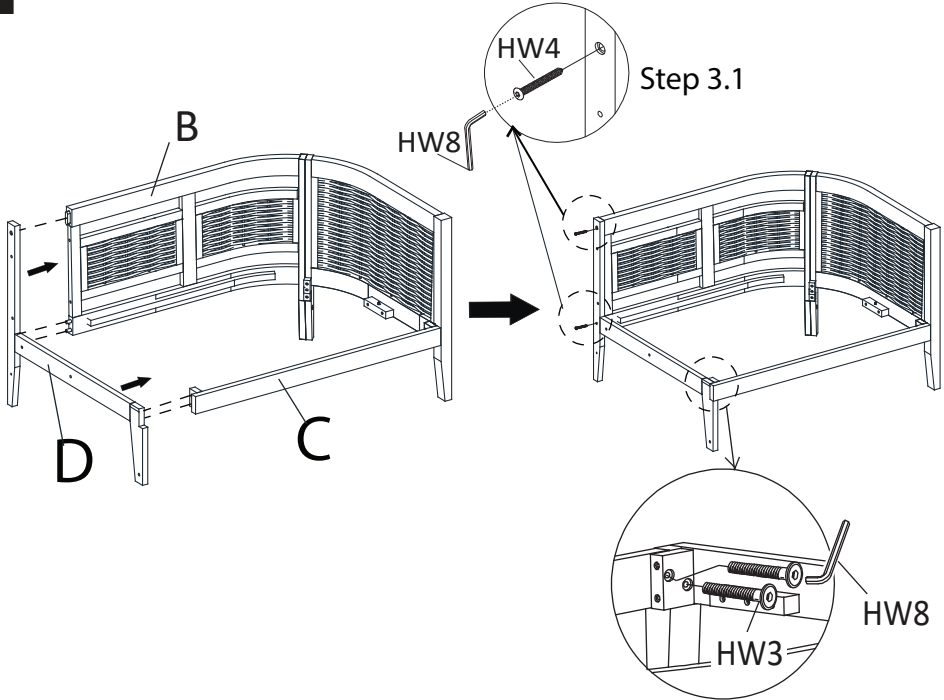
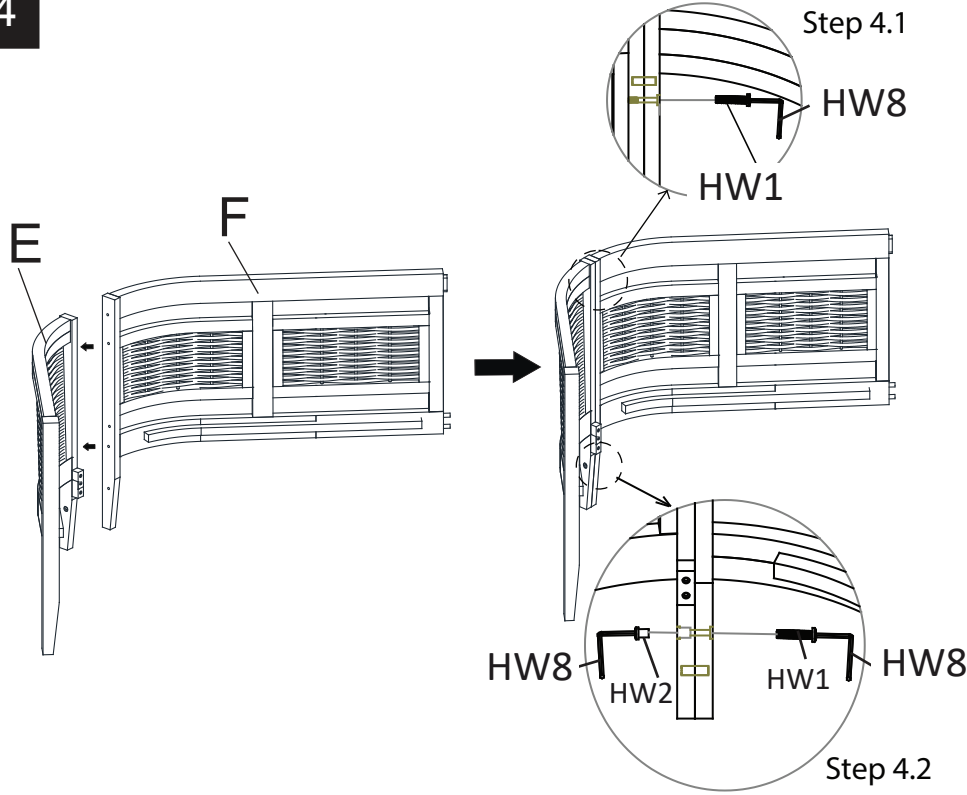
|   |  |
|---|--|
| <div data-bbox="152 400 197 448" style="background-color: black; color: white; padding: 5px; font-weight: bold; font-size: 24px;">3</div>  <p style="text-align: center;">Step 3.1</p> <p style="text-align: center;">Step 3.2</p> | <div data-bbox="1193 400 1238 448" style="background-color: black; color: white; padding: 5px; font-weight: bold; font-size: 24px;">4</div>  <p style="text-align: center;">Step 4.1</p> <p style="text-align: center;">Step 4.2</p>   |
| <p><b>Step 3.1</b><br/>Attach the Left Middle Leg Panel (D) to the Left Backrest Panel (B) using Screws (HW4) and the Allen key (HW8) as shown above.</p> <p><b>Step 3.2</b><br/>Attach the Left Middle Leg Panel (D) to the Left Support Bar (C) using Bolts (HW3) and the Allen key (HW8) as shown above.</p>       | <p><b>Step 4.1</b><br/>Attach the Right Backrest Panel (F) to the Right leg Panel (E) using Bolts(HW1) and the Allen key (HW8 ) as shown above.</p> <p><b>Step 4.2</b><br/>Attach the Right Backrest Panel (F) to the Right leg Panel (E) using Bolts(HW1), Insert Nuts(HW2 ) and the Allen key (HW8 ) as shown above.</p> |

# PREPARATION

- \*Before beginning assembly of product, make sure all parts are present. Compare parts with package contents list and hardware contents list.
- \*If any part is missing or damaged, do not attempt to assemble the product.
- \* Estimated Assembly Time : 10 minutes.
- \* Tools Required for Assembly (included): Allen Key
- \* If you are having difficulty, our friendly Customer care team is always here to help.

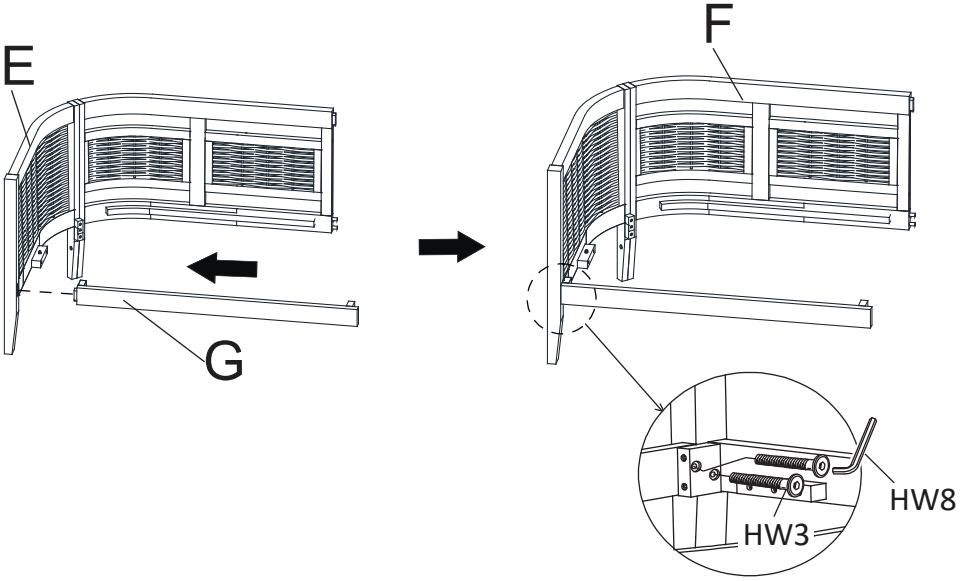
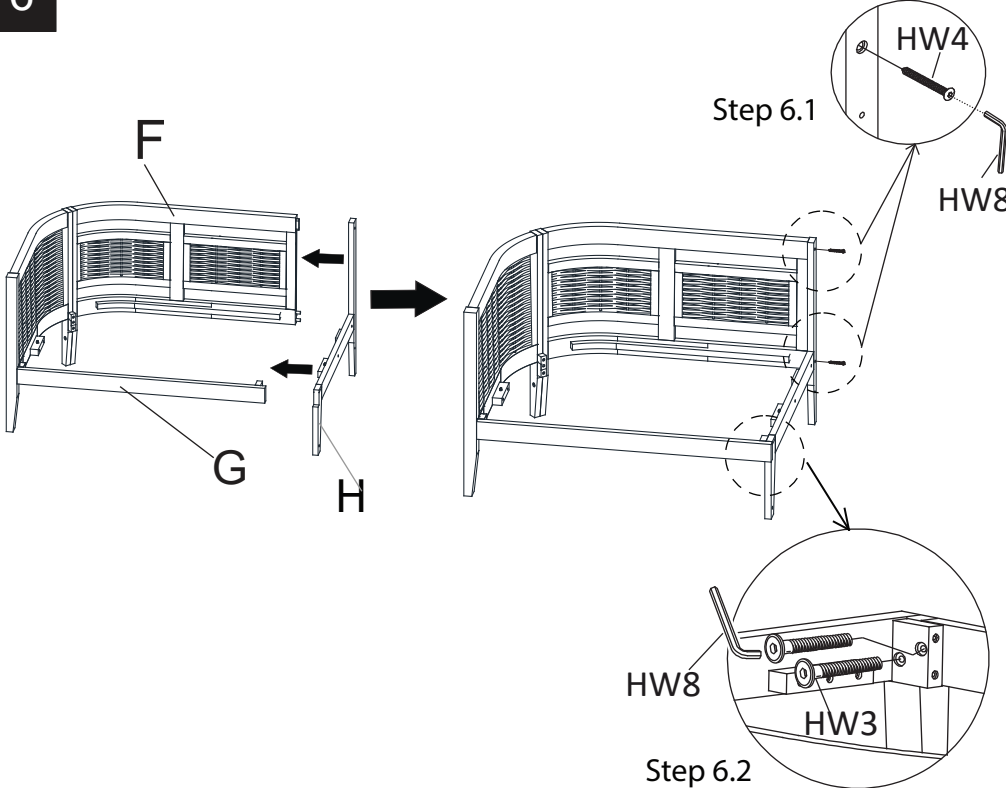
|   |  |
|---|--|
| <p><b>5</b></p>  <p><b>Step 5</b><br/>Attach the Right Support Bar (G) to the Right leg Panel (E) using Bolts(HW3), the Allen kay (HW8 ) as shown above.</p> | <p><b>6</b></p>  <p><b>Step 6.1</b><br/>Attach the Right Middle Leg Panel (H) to the Right Backrest Panel (F) using Screws (HW4) and the Allen kay (HW8 ) as shown above.</p> <p><b>Step 6.2</b><br/>Attach the Right Middle Leg Panel (H) to the Right Support Bar (G) using Bolts (HW3) and the Allen kay (HW8 ) as shown above.</p> |
|---|--|

# PREPARATION

- \*Before beginning assembly of product, make sure all parts are present. Compare parts with package contents list and hardware contents list.
- \*If any part is missing or damaged, do not attempt to assemble the product.
- \* Estimated Assembly Time : 10 minutes.
- \* Tools Required for Assembly (included): Allen Key
- \* If you are having difficulty, our friendly Customer care team is always here to help.

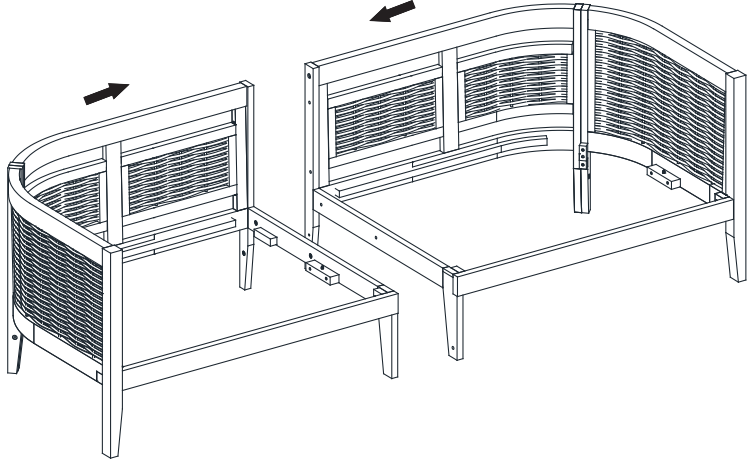
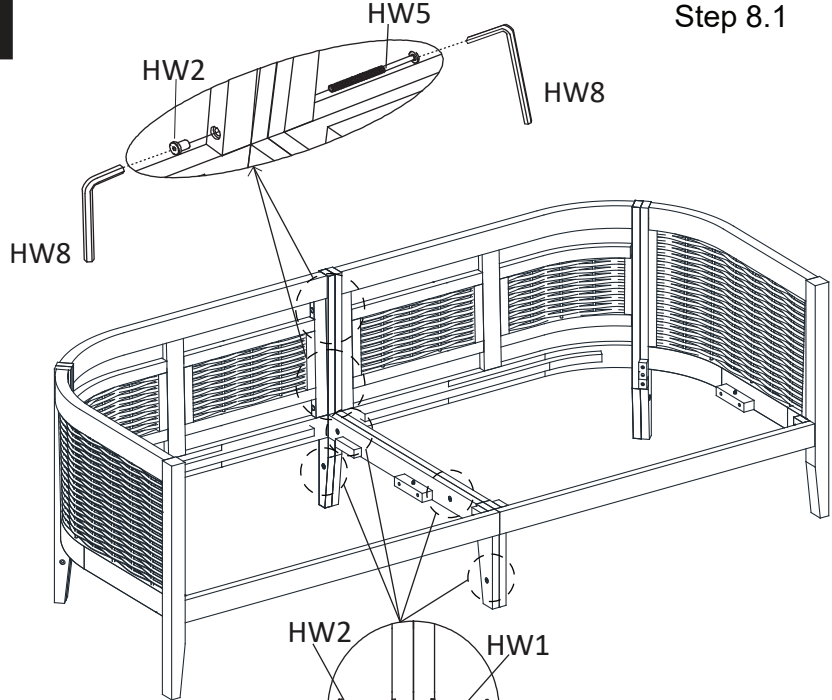
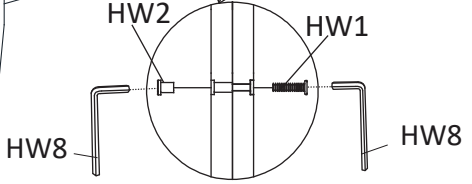
|  |  |
|--|--|
| <p><b>7</b></p>    | <p><b>8</b></p> <p>Step 8.1</p>  <p>Step 8.2</p>  |
| <p><b>Step 7</b></p> <p>With assistance from your adult partner(s), attach the assembled parts in step 7<br/>o the assembled parts in step 3</p> | <p><b>Step 8.1</b><br/>using Bolts ( HW5) and Insert Nuts (HW2) the Allenkey(HW8)<br/>as shown above.</p> <p><b>Step 8.2</b><br/>using Bolts ( HW1) and Insert Nuts (HW2) the Allenkey(HW8)<br/>as shown above.</p>        |

# PREPARATION

- \*Before beginning assembly of product, make sure all parts are present. Compare parts with package contents list and hardware contents list.
- \*If any part is missing or damaged, do not attempt to assemble the product.
- \* Estimated Assembly Time : 10 minutes.
- \* Tools Required for Assembly (included): Allen Key
- \* If you are having difficulty, our friendly Customer care team is always here to help.

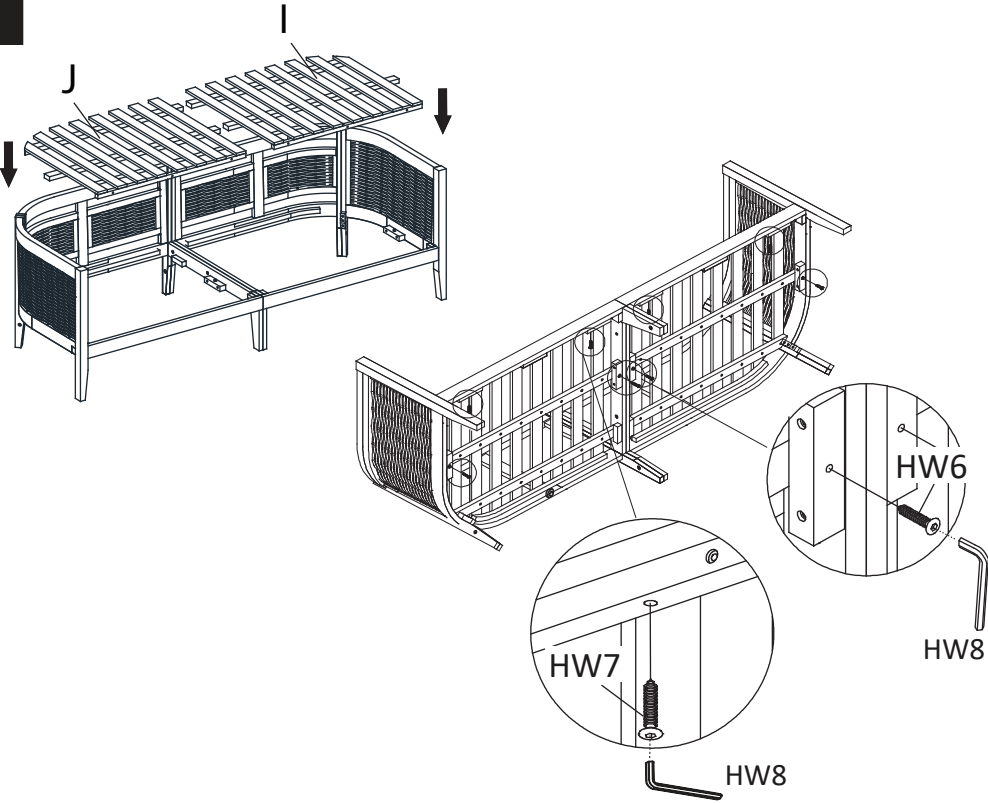
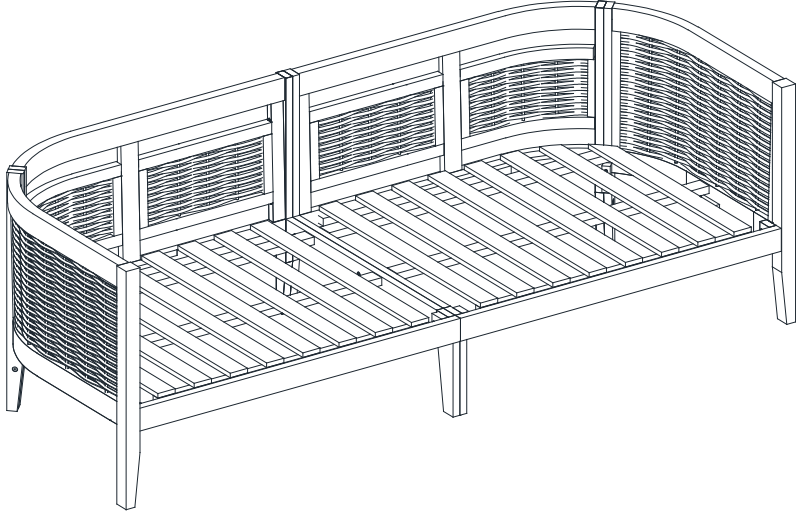
|   |  |
|---|--|
| <p><b>9</b></p>  <p>The diagram illustrates the process of attaching the seat panels (I and J) to the chair frame. Two panels, labeled I and J, are shown being lowered onto the frame. A detailed view shows the panels being secured with screws HW6 and HW7. Hardware HW8, which are Allen keys, are used to tighten the screws. The diagram shows the Allen key being inserted into the frame from the inside to secure the panels from the outside.</p> | <p><b>10</b></p>  <p>The diagram shows the 3-seater chair after being turned right side up. The chair is shown from a perspective that highlights the seat panels and the frame.</p> |
| <p><b>Step 9</b><br/>Attach the Seat Panel (I), (J) into the Chair as shown in picture above.<br/>Affix the Seat Panel (I), (J) to the Chair using Screws(HW6),(HW7) and the Allen (HW8).<br/>Note: Insert the Screws(HW7) from the inside to the outside of the Seat Panel(I),(J).</p>   | <p><b>Step 10</b><br/>Turn the 3 Seater right side up.</p>   |

# PREPARATION

- \*Before beginning assembly of product, make sure all parts are present. Compare parts with package contents list and hardware contents list.
- \*If any part is missing or damaged, do not attempt to assemble the product.
- \* Estimated Assembly Time : 10 minutes.
- \* Tools Required for Assembly (included): Allen Key
- \* If you are having difficulty, our friendly Customer care team is always here to help.

11

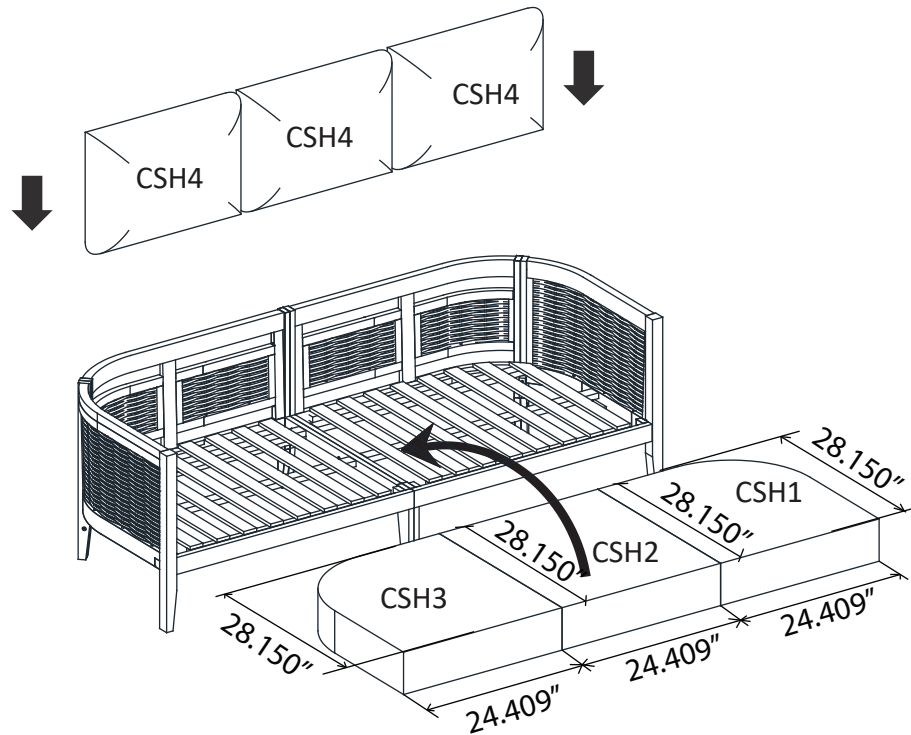

Step 11

Place the Right Seat Cushion (CSH3), Middle seat cushion (CSH2), Left Seat Cushion (CSH1) and the Back Cushions (CSH4) onto the 3 Seater.

12

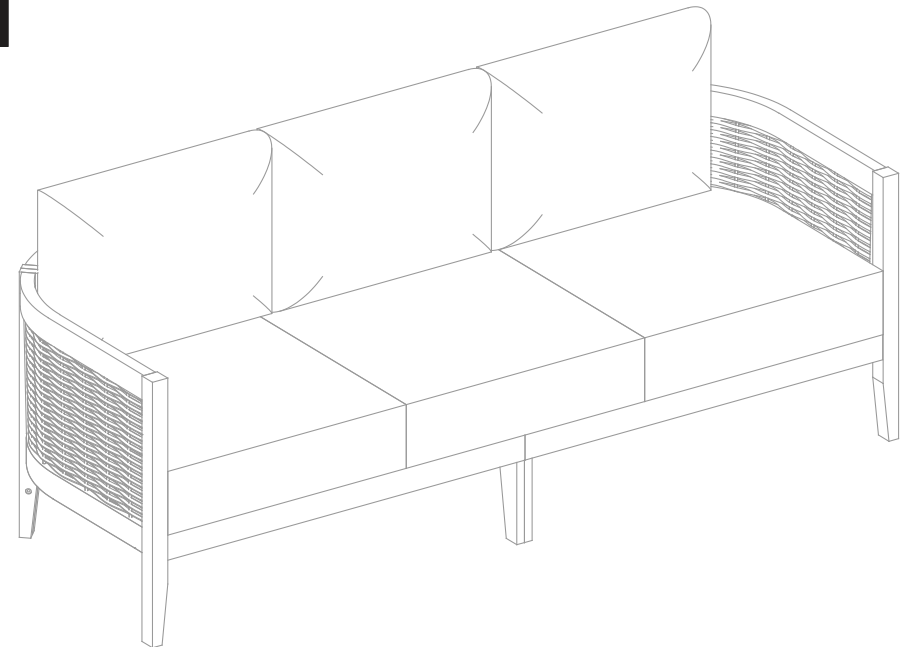

Step 12

Your Chair is ready to be used.