

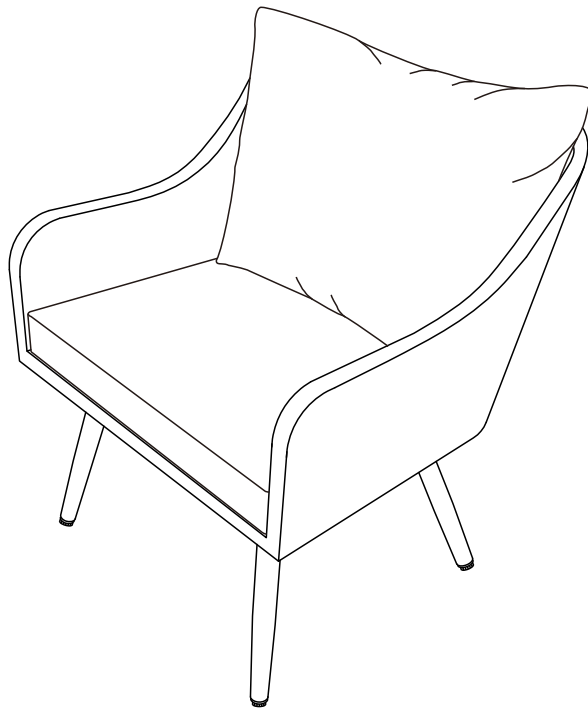

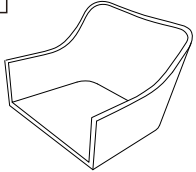

Outdoor Arm Chair

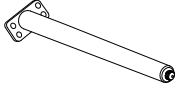
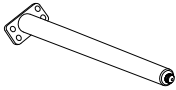
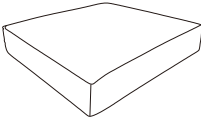
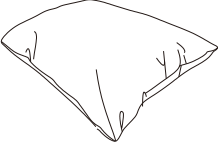

PART LIST

A 	B 	C 	D 	E 
Seat Panel 2 PCS	Front Leg 4 PCS	Back Leg 4 PCS	Seat Cushion 2 PCS	Back Cushion 2 PCS

HARDWARE LIST

#1 	#2 	#3 
M6*15mm Bolt 32 PCS (Extra 1)	M6mm Flat Washer 32 PCS (Extra 1)	M6mm Allen Wrench 1 PC

Step 1. Lay seat panel (part A) upside down on a soft flat surface, such as carpet, as shown below. Attach front legs (part B) and back legs (part C) to seat panel (part A) using bolts (part #1), flat washers (part #2) and allen wrench (part #3).

NOTE: Please fully tighten all bolts at this time.

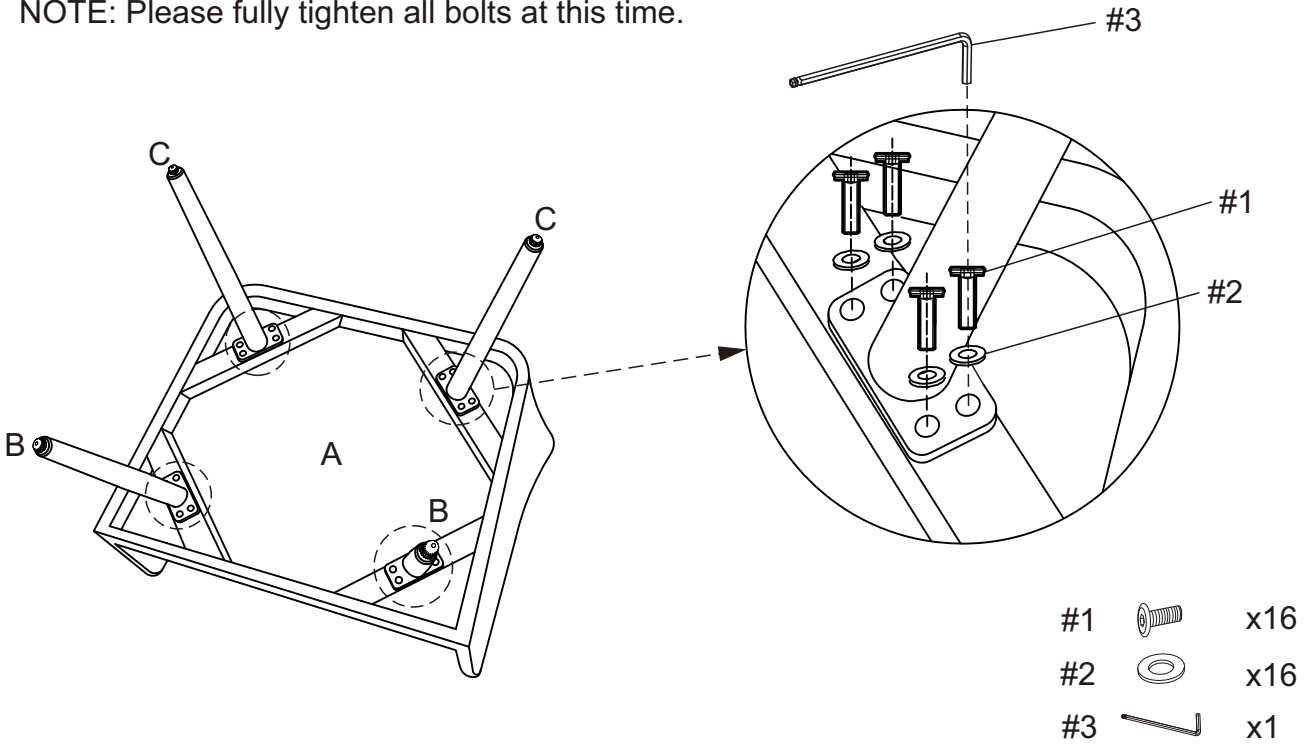

Step 2. Carefully turn unit upright. Add seat cushion (part D) and back cushion (part E) as shown below. Repeat step 1 to assemble remaining chair.

