

Owner Manual



Per Seat Weight Limitation

150 LBS

NOTE:





This brochure contains
IMPORTANT safety info.
Please read and keep it
for future reference.

MAINTENANCE AND WARNINGS



Before You Start

Please follow the steps below:

-  Check the packaging for any damage, deformation, or water stains. If there is significant damage, please contact us promptly.
-  Open the packaging and confirm that the panels, hardware, screws, etc are complete.
-  Please read the installation instructions carefully to understand the installation steps and precautions to ensure proper installation.
-  Clean the installation area in advance and ensure the ground is level and there is enough space to avoid damaging the furniture or making installation difficult.
-  Lay a protective mat on the ground to prevent scratching the floor during installation.

After-Sales Service

- If you encounter any issues or need technical support during use, please contact our after-sales team. We offer long-term maintenance and warranty services.



Precautions

- ⚠ This product for indoor use only. Do not expose it to outdoor elements or high-humidity environments.
- ⚠ Keep the product away from high heat or open flames to prevent fire hazards.
- ⚠ Do not allow children to climb on the product to prevent personal injury caused by tipping



Safety Warnings

- ⚠ If you notice any loose or damaged parts, stop using the product immediately and contact customer service.
- ⚠ Do not attempt to disassemble or replace any components yourself, as this may affect the stability and safety of the product.

Daily Maintenance



- Regularly clean the surface of the sofa with a soft cloth to prevent dust accumulation.

Do not use cleaning agents containing acids, alkalis, or corrosive substances, as they may damage the surface. It is recommended to use neutral cleaning agents or specialized furniture cleaners
- Avoid exposing furniture to humid environments for extended periods to prevent swelling or deformation of the boards. Use a dehumidifier or desiccant during humid weather.
- Avoid direct contact of furniture with water. If water is accidentally spilled, wipe it dry immediately.
- Avoid placing excessively heavy objects on the furniture: ensure the weight is within a reasonable load-bearing range.
- Avoid using sharp or rough items on the furniture surface to prevent scratches, Handle items gently when moving them

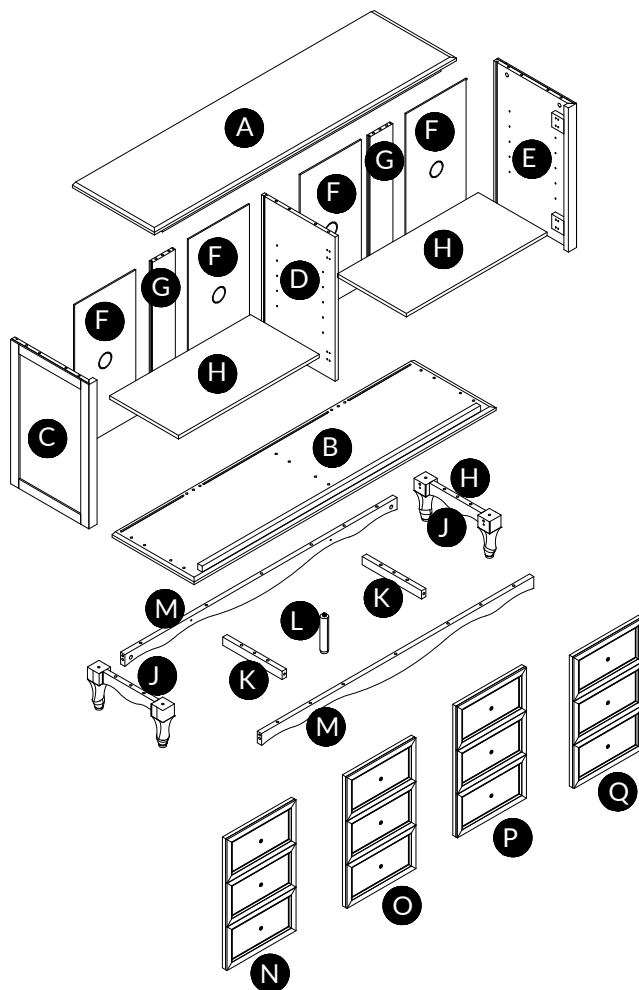
Explosive view

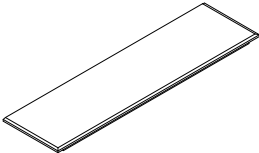
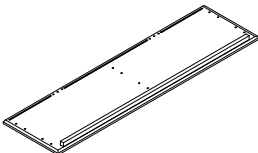
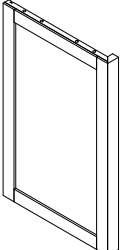
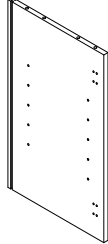
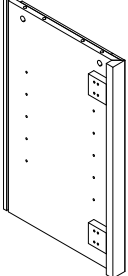
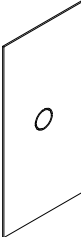

Parts list

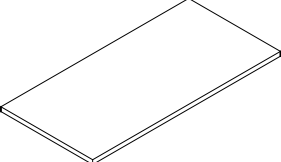
<p>A</p>  <p>x1</p>	<p>B</p>  <p>x1</p>
<p>C</p>  <p>x1</p>	<p>D</p>  <p>x1</p>
<p>E</p>  <p>x1</p>	<p>F</p>  <p>x4</p>
<p>G</p>  <p>x2</p>	<p>H</p>  <p>x2</p>



Installation:
45minutes.



Two Person

Parts list

J

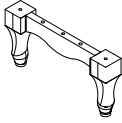

x2

K



x2

L



x1

M

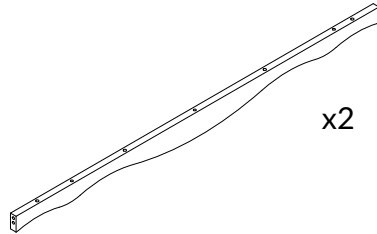

x2

N

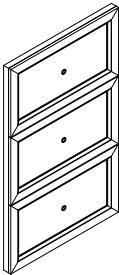

x1

O

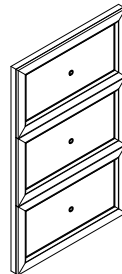

x1

P

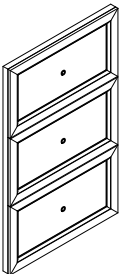





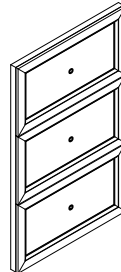



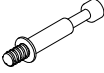

x1

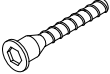
Q







x1

Hardware List

<p>1</p>  <p>x18+2</p> <p>D6x35mm</p>	<p>2</p>  <p>x18+2</p> <p>D15x12mm</p>	<p>3</p>  <p>x30+3</p> <p>D8x30mm</p>
<p>4</p>  <p>x14+1</p> <p>D7x40mm</p>	<p>5</p>  <p>x48+4</p> <p>D4x16mm</p>	<p>6</p>  <p>x18+2</p>
<p>7</p>  <p>x16+1</p> <p>D6x40mm</p>	<p>8</p>  <p>x8</p> <p>x4</p>	<p>9</p>  <p>x4</p> <p>Large Bend</p>
<p>10</p>  <p>x4</p> <p>Medium Bend</p>	<p>11</p> <p>#11</p>  <p>x4</p>	<p>12</p>  <p>x2</p>

Hardware List

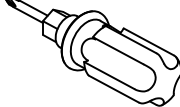
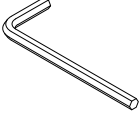
<p>13</p>  <p>x16</p>	<p>14</p>  <p>x12</p> <p>D4x22mm</p>	<p>15</p>  <p>x20</p> <p>D3.5x14mm</p>
<p>16</p>  <p>x4</p>	<p>17</p>  <p>x4</p> <p>D4x30mm</p>	<p>18</p>  <p>x1</p>
<p>19</p>  <p>x1</p>		

Step 1

Prepare for part M & J

1. Tighten the bolt #1 into the corresponding hole of M & J with screwdriver #18
2. Align the holes in part M, insert wooden dowel #3 by hand

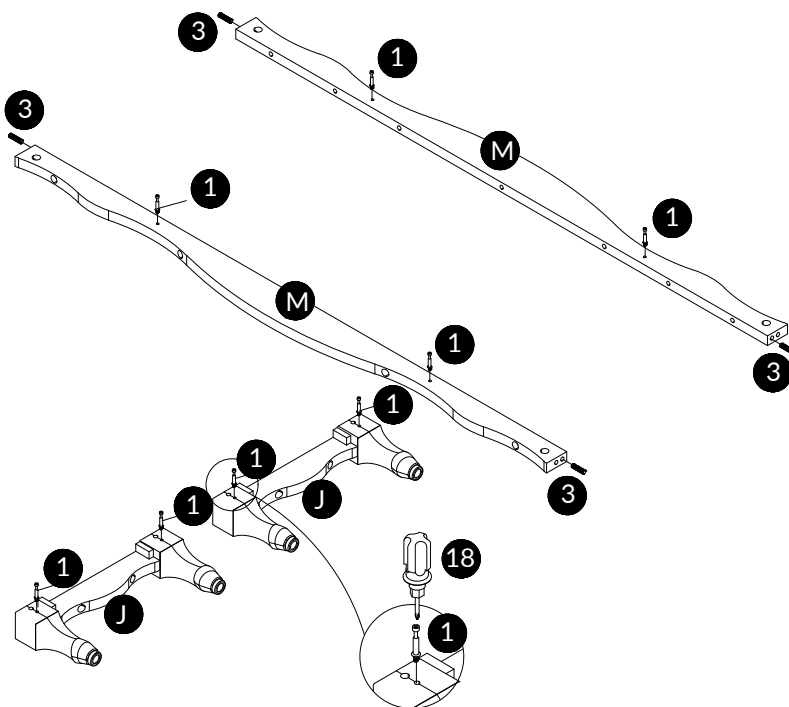

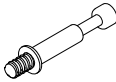
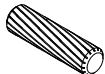
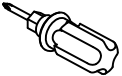

1	x8	3	x4	18	x1
					
D6x35mm		D8x30mm			

Step 2

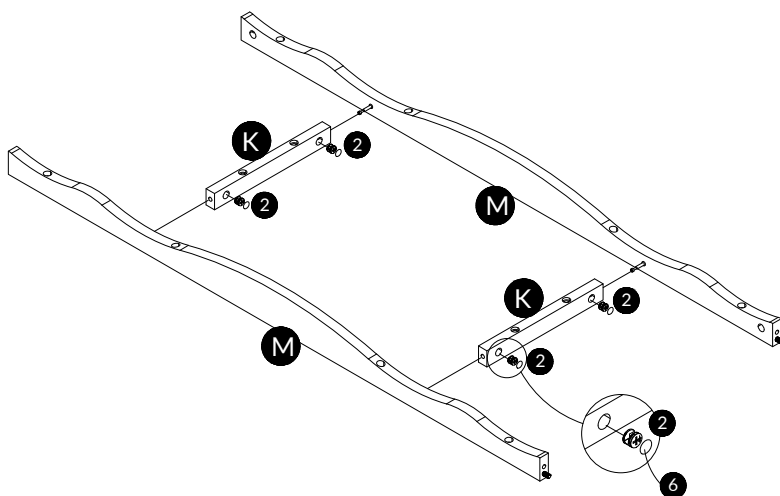
1. Insert cam bolt #2 into the corresponding hole of panel K, then tighten the cam bolt #2 with screwdriver #18
2. Cover the cam lock #2 with sticker #6



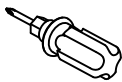

2	x4	6	x4	18	x1
					
D15x12mm					

Step 3

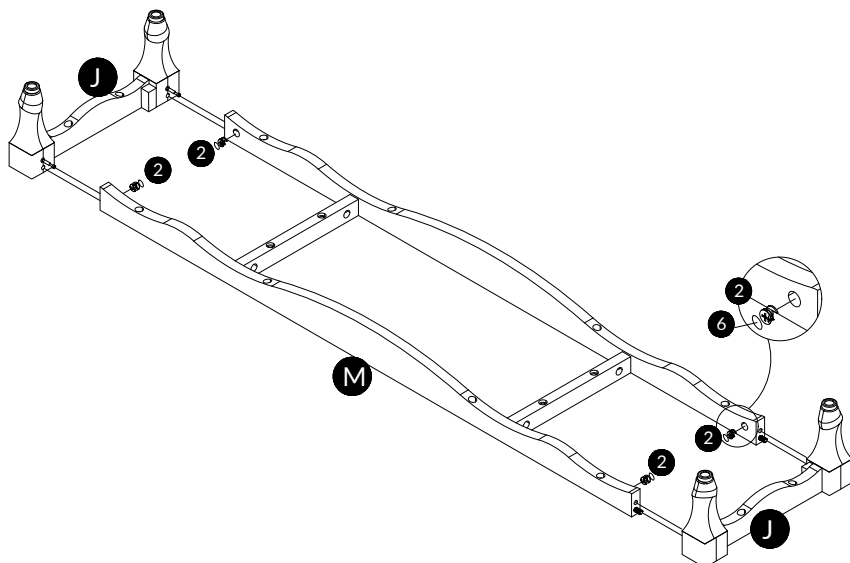
1. Insert cam bolt #2 into the corresponding hole of panel M, then tighten the cam bolt #2 with screwdriver #18
2. Cover the cam lock #2 with sticker #6



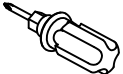

2	x4	6	x4	18	x1
					
D15x12mm					

Step 4

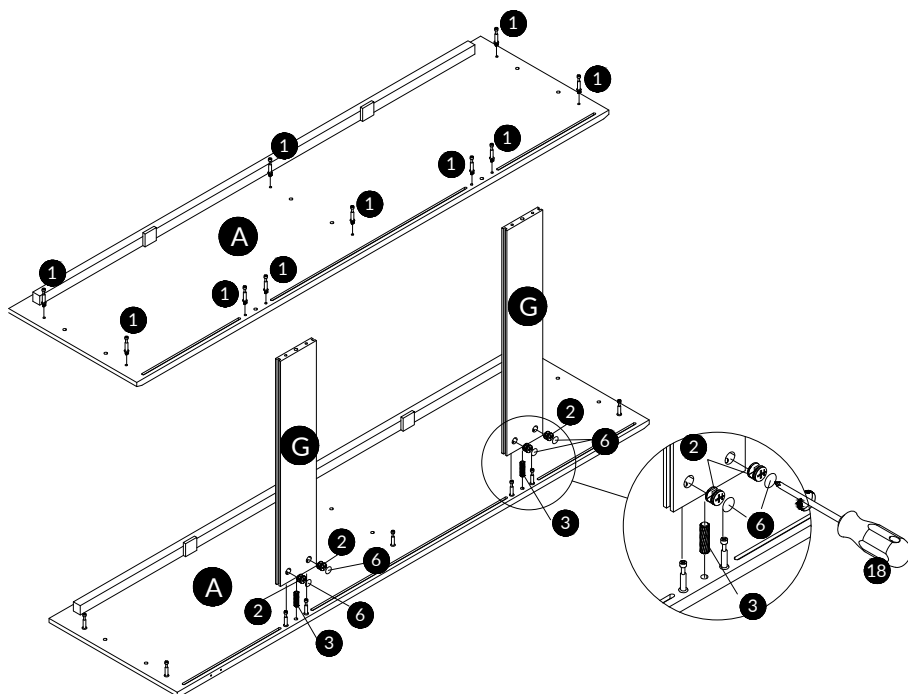
1. Tighten the bolt #1 into the corresponding hole of A with screwdriver #18 as picture show
2. Align the holes in part A, insert wooden dowel #3 by hand
3. Connect the part G with part A, insert cam bolt #2 into the corresponding hole of panel G. then tighten the cam bolt #2 with screwdriver #18
4. cover the cam lock #2 with sticker #6

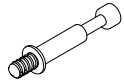
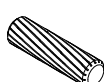

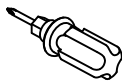

1	x10	3	x2	2	x4	6	x4	18	x1
									
D6x35mm		D8x30mm		D15x12mm					

Step 5

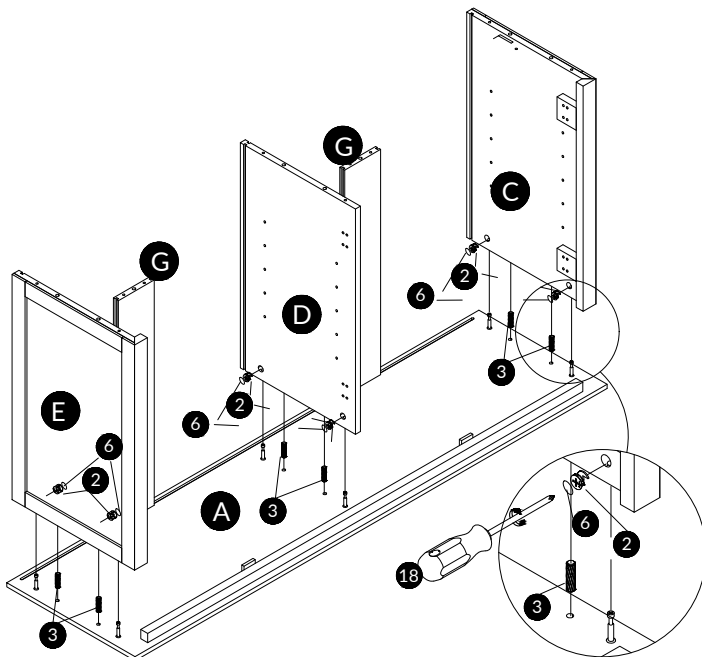
- 1.Align the holes in part A, insert wooden dowel #3 by hand
- 2.Connect the part C&D&E with part A,
insert cam bolt #2 into the corresponding hole of panel C&D&E,then tighten the cam bolt #2 with screwdriver #18
- 3.cover the cam lock #2 with sticker #6

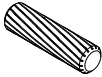

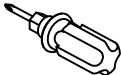
3	x6	2	x6	6	x6	18	x1
							
D8x30mm		D15x12mm					

Step 6

1. Slide in the part F into the groove in part E,G and G,D and D,G,and G,C . make sure they are also in groove in part A
2. Please make sure that the panels which stick "BACK" are towards wall

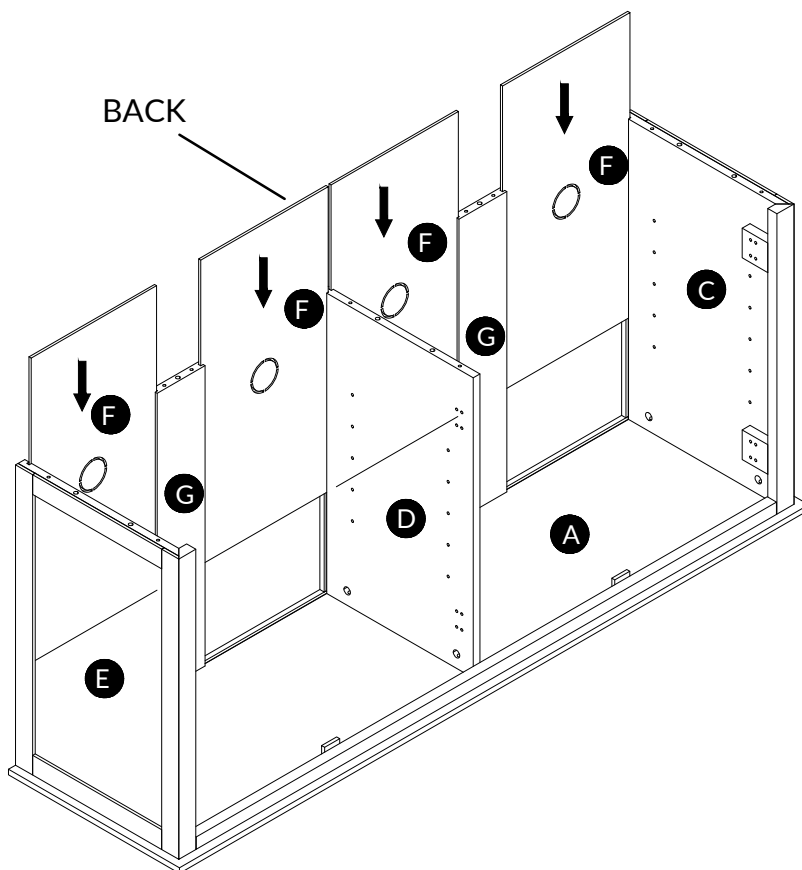

Step 7

- 1.Align the holes in part C&D&E, insert wooden dowel #3 by hand
- 2.Connect the part C&D&E with part B,tighten screw #4 with allenkey #19

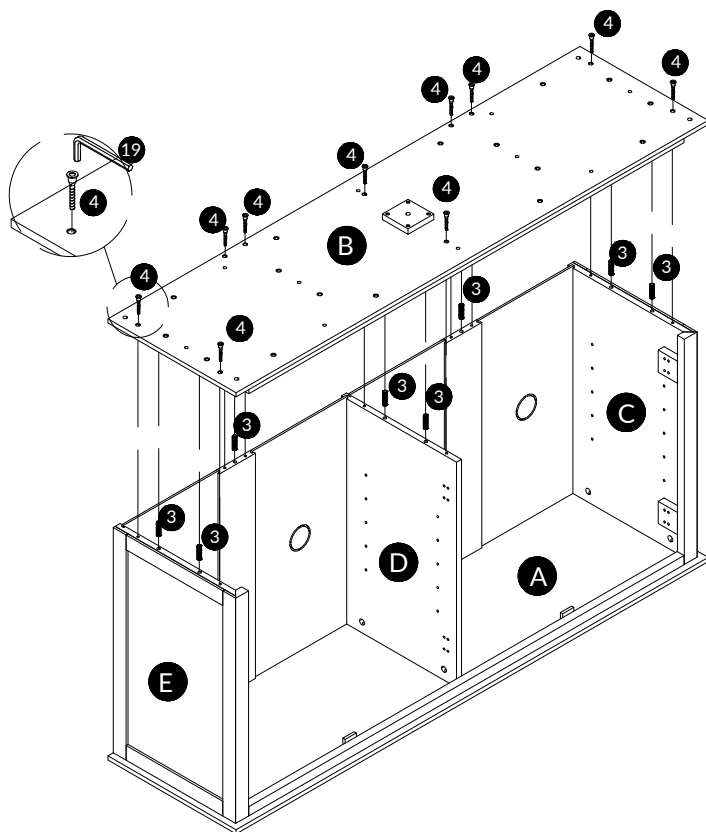

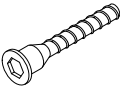
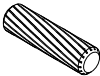
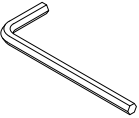
4	x10	3	x8	19	x1
					
D7x40mm		D8x30mm			

Step 8

1. Align the holes in part B, insert wooden dowel #3 by hand
2. Connect the leg with part B, tighten screw #7 with allenkey #19
3. Screw foot L into part B by hand as picture show

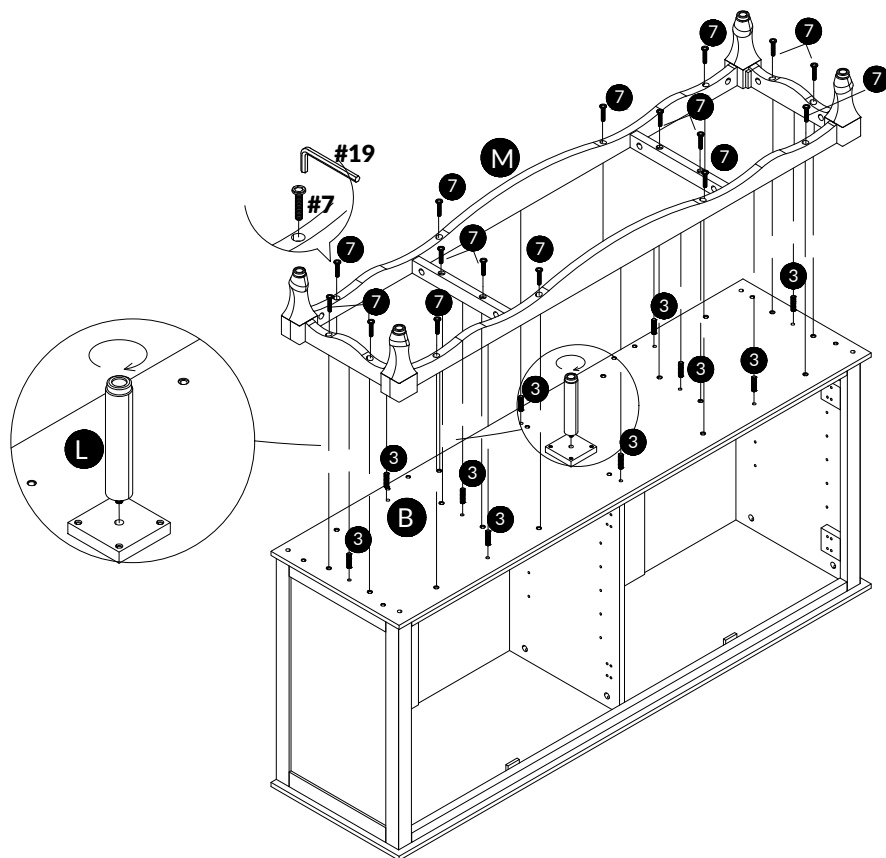

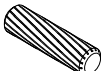
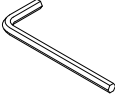
7	x16	3	x10	19	x1
					
D6x40mm		D8x30mm			

Step 9

Tighten screw #4 into the corresponding hole with allenkey #19

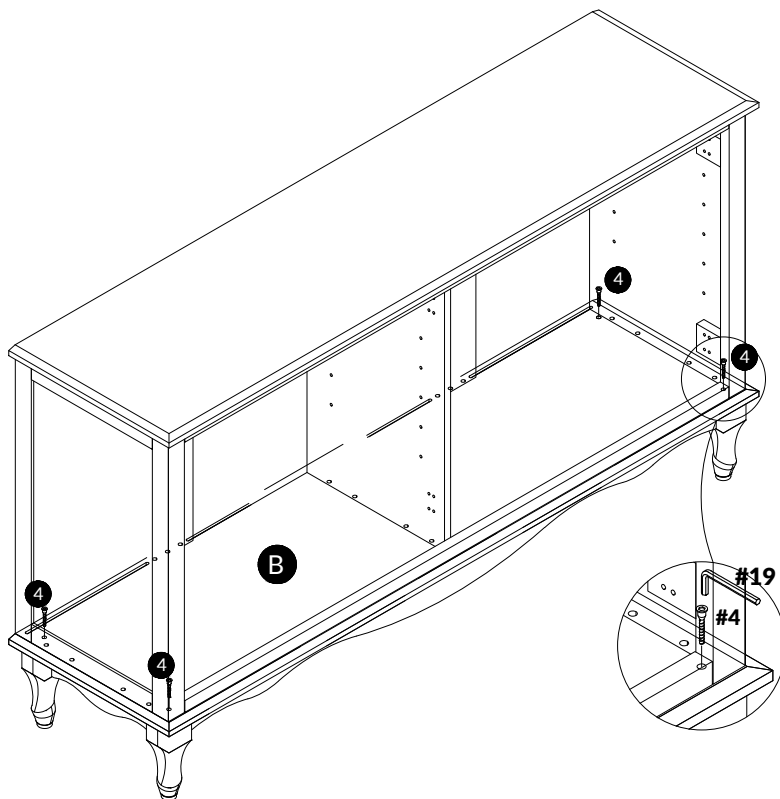

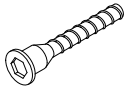
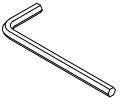
4	x4	19	x1
			
D7x40mm			

Step 10

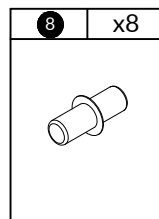
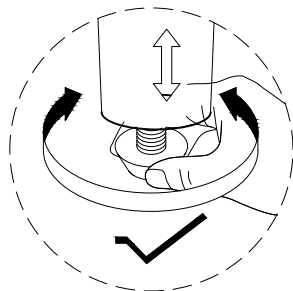
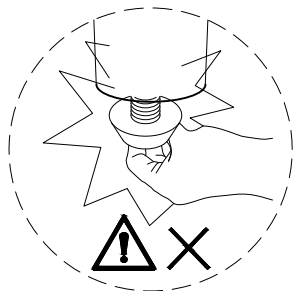
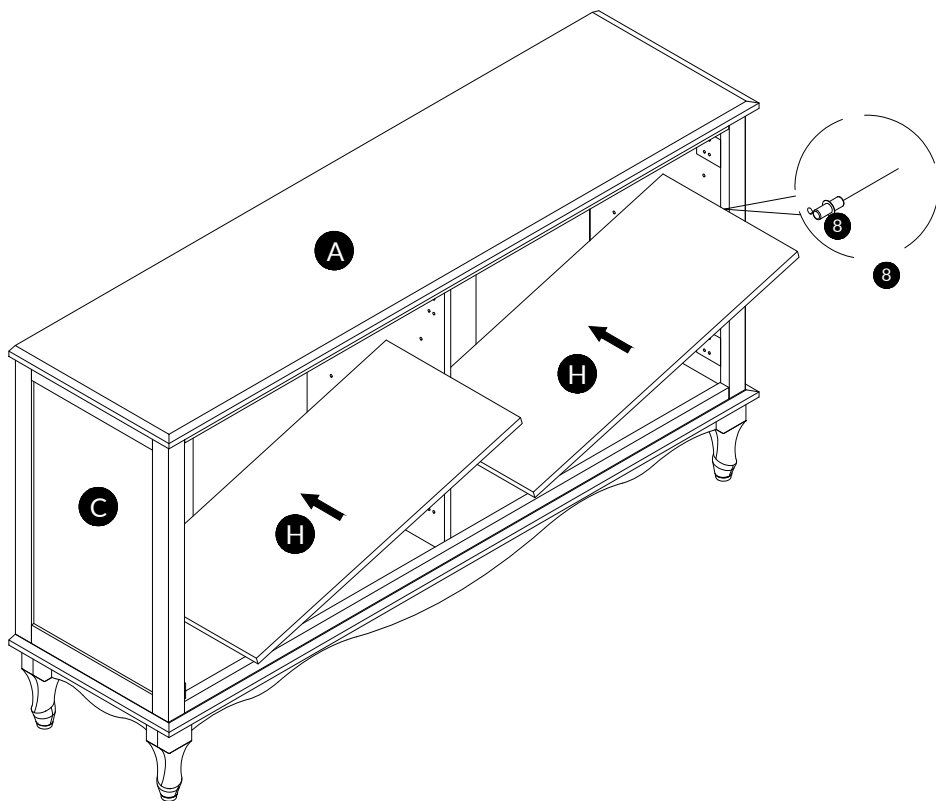

Insert shelf pin #8 into the holes attach adjustable shelf H to pin #8

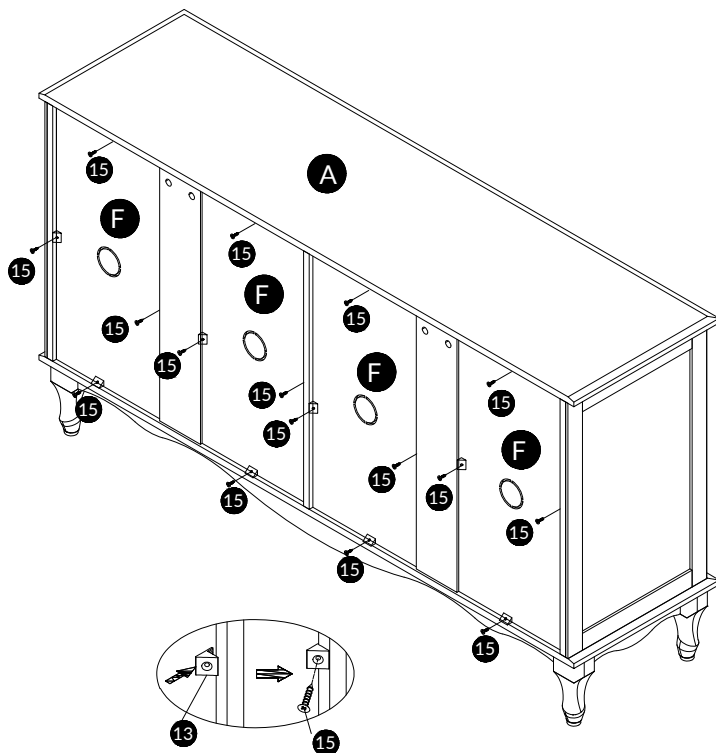

Step 11

Insert hardware #13 into part F as shown, screw in screw #15 using screwdriver #18 and tighten fully.

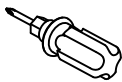

13	x16	15	x16	18	x1
					
D7x40mm		D3.5x14mm			

Step 12

1. Use screw #5 to attach the hinges #9(Large bend) to door panel (N&Q), tighten screws #5 with screwdriver #18.
2. Use screw #14 to attach the handle #14 to door panel (N&Q), tighten screws #14 with screwdriver #18.

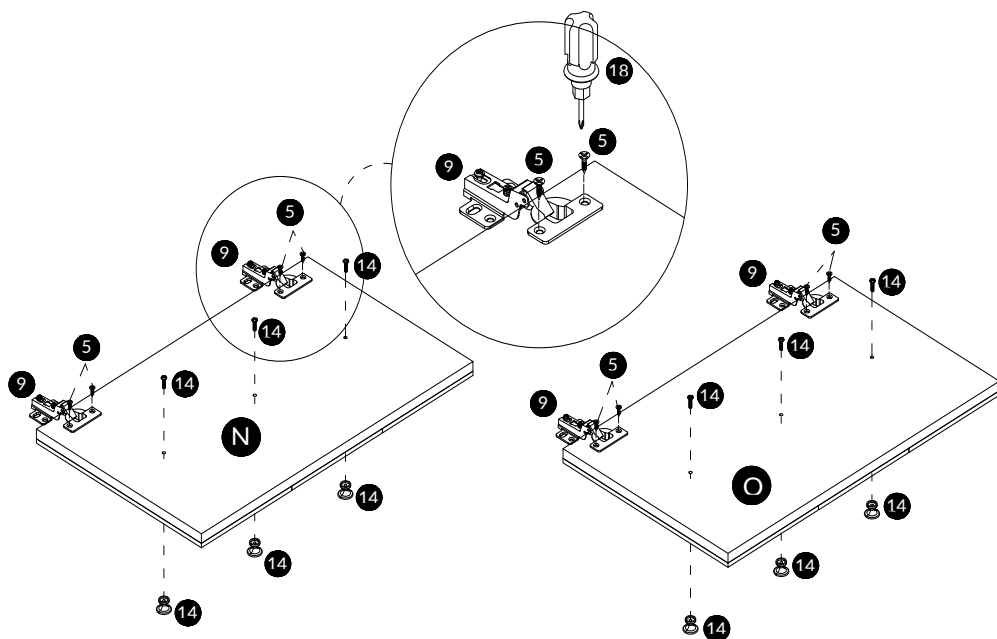

9	x4	14	x6	5	x8	18	x1
Large Bend		D4x22mm		D4x16mm			

Step 13

1. Use screw #5 to attach the door N to side panel C, tighten screws #5 with screwdriver #18.
2. Use screw #5 to attach the door Q to side panel E, tighten screws #5 with screwdriver #18.

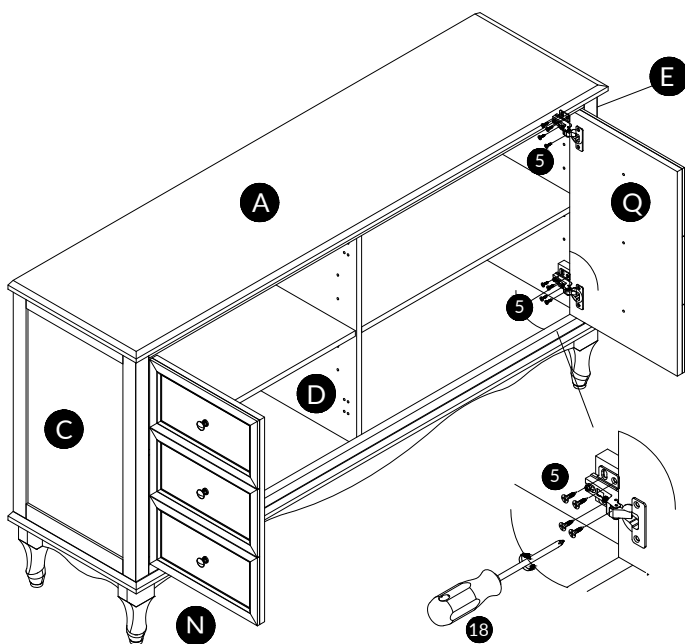

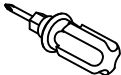
5	x16	18	x1
			
D4x16mm			

Step 14

1. Use screw #5 to attach the hinges #10(Medium bend) to door panel (O&P), tighten screws #5 with screwdriver #18.
2. Use screw #14 to attach the handle #14 to door panel (O&P), tighten screws #14 with screwdriver #18.

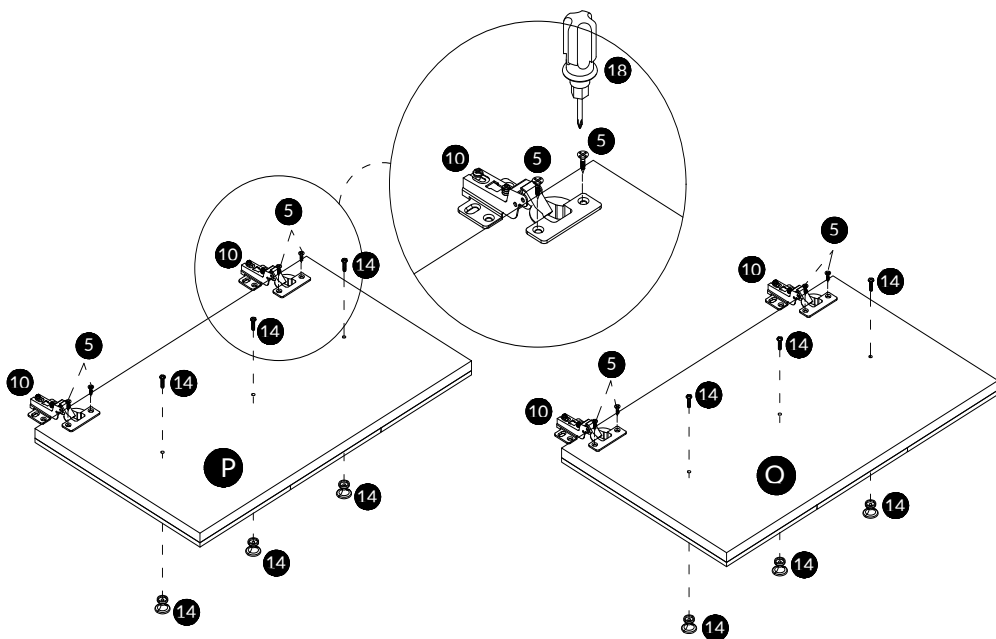

10	x4	14	x6	5	x8	18	x1
Medium Bend		D4x22mm		D4x16mm			

Step 15

1. Use screw #5 to attach the door O to left side of panel D, tighten screws #5 with screwdriver #18.
 2. Use screw #5 to attach the door P to right side of panel D, tighten screws #5 with screwdriver #18.
- Make sure the doors (O&P) are installed as picture show

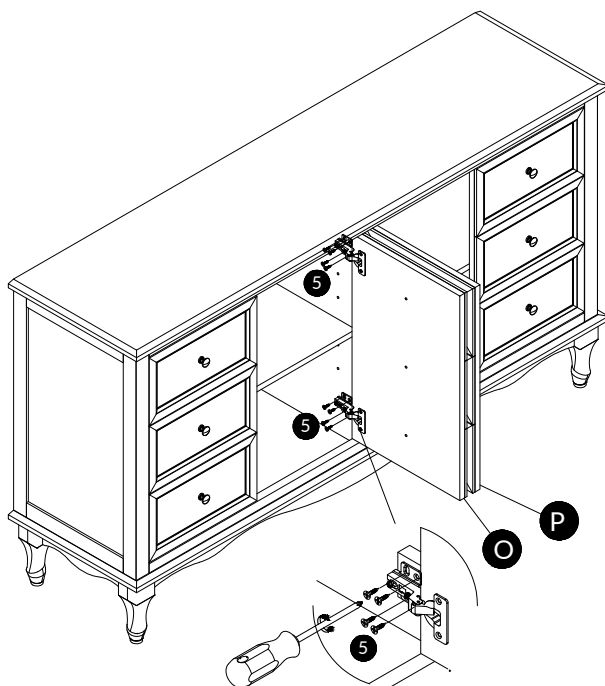

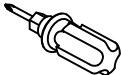
5	x16	18	x1
			
D4x16mm			

Door Hinge Adjustment Instructions

Concealed hinges are three-way adjustable:

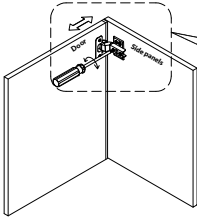

Horizontal
by screw adjustment!

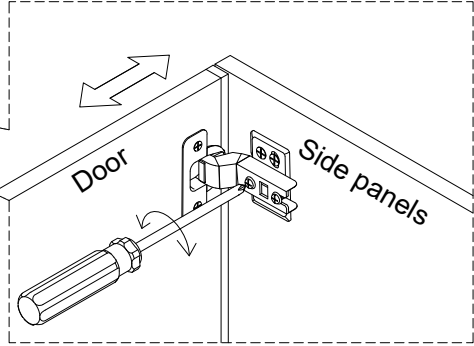

Concealed hinges are three-way adjustable:

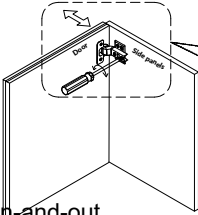

In and out
by loosening the hinge arm
mounting screw or via cam
adjustment!

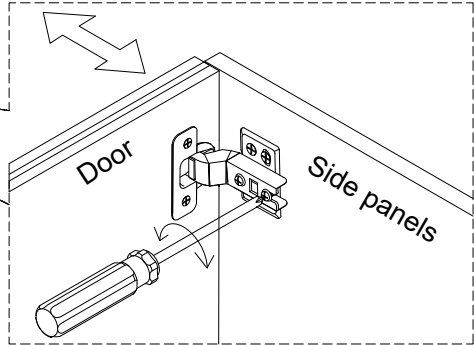

Concealed hinges are three-way adjustable:

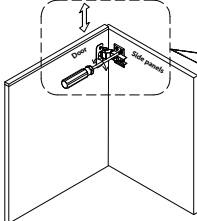

Vertical via slots in
the mounting plate
or via cam
adjustment!

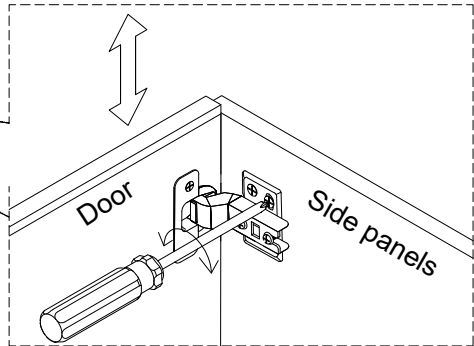



Hinge adjustment method

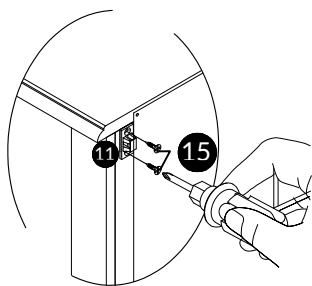
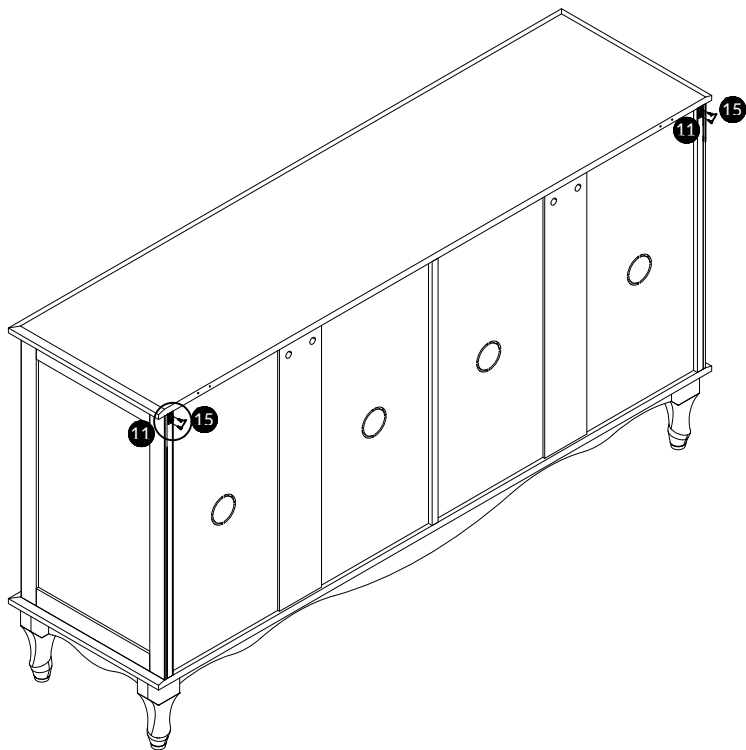

Step 16

Use screws #15 to attach part #11 with screwdriver #18 as picture shown

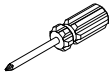

15	x4	11	x2	18	x1
					
D3.5x14mm					

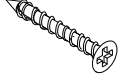
Step 17

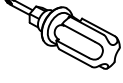
11	x2	17	x4	16	x4	18	x1
							
		D4x30mm					

1. Install the anti-collapse device.
2. Mark the position on the wall, that corresponds to the location of part #11 on the of panel (A); Drill and insert the expandable screw #16 by hammer.
3. Assemble the part #11 to the wall. Align the hole in the part #11 with the expandable screw #16, use screw #17 to attach it and tighten by screwdriver #18.

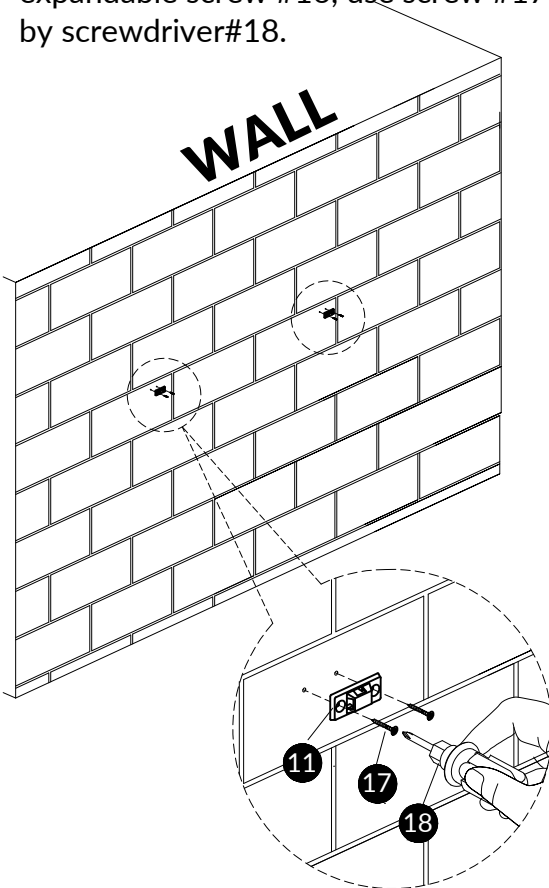

NOT PROVIDED

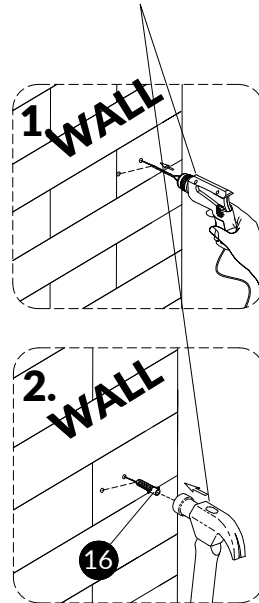

Step 18

Let the plastic belt #12 pass through the both part #11 and pull tightly.

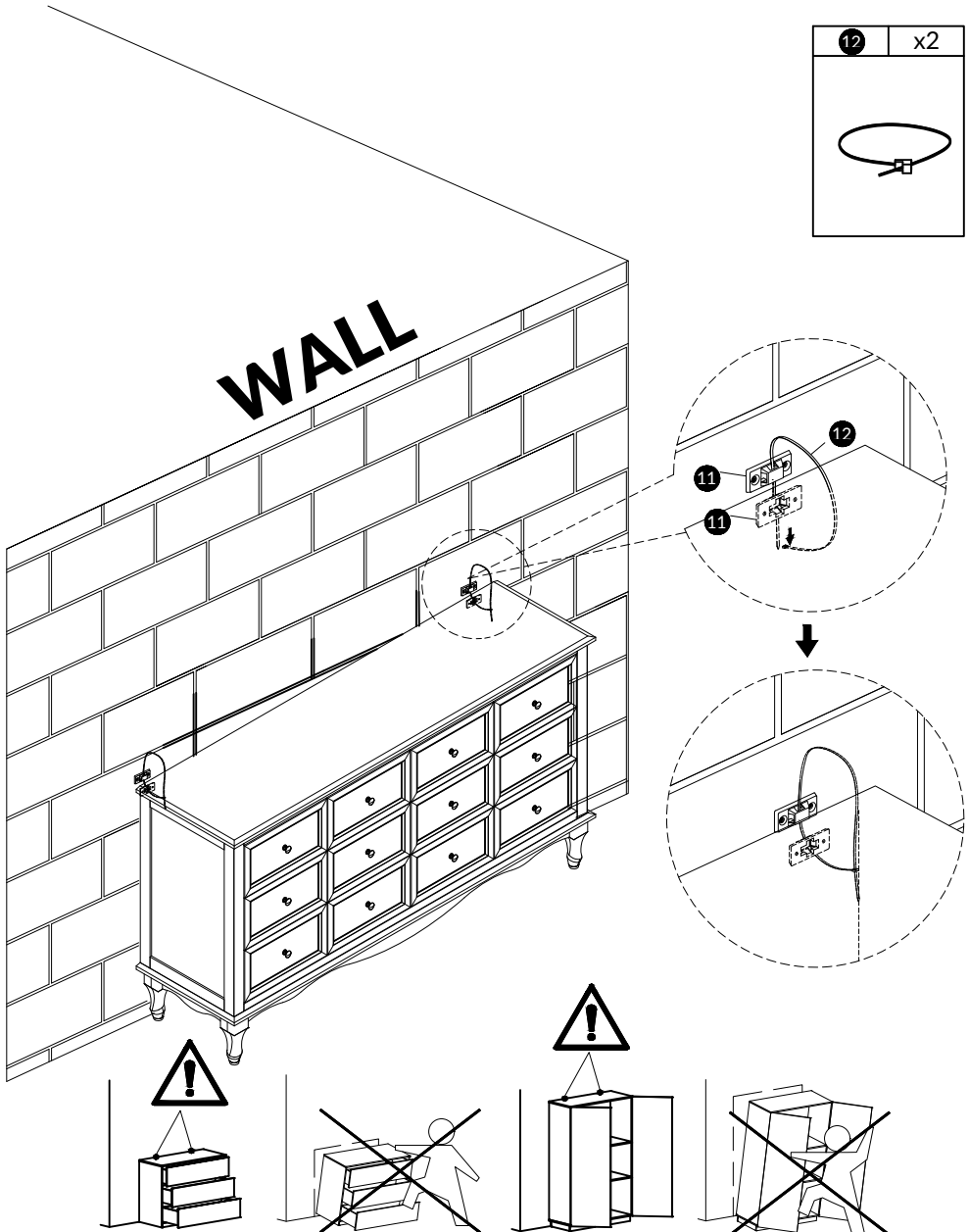

WARRANTY

- We strive to offer quality products, and we also try our best to satisfy every customer who orders from us with products or services as needed.
- We provide 30 days warranty starting from the time you receive the item. Each customer must provide a record of their orders such as the order number, or item receipt for any items that are out of the warranty period you may also still receive.
- Replacement parts by purchasing them from our company if they are available.
- For return, please check the return policy with the retailer or market place you bought from