

# MOUNTING AND WIRE

## 1. Take out Mounting Bracket

Loosen the M5 nut (C) from the canopy(B), and take out the mounting bracket(A).

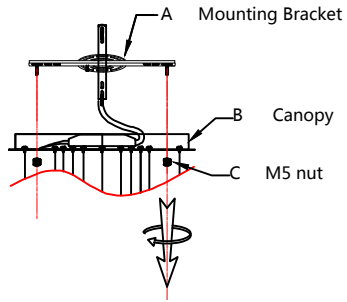

## 2-1. Installation Method One: Installation bracket method for solid wood ceiling structure.

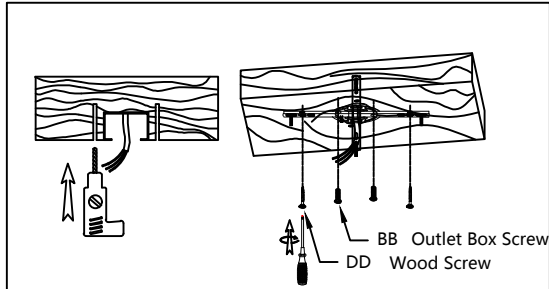

Mark and drill screw holes on the installation position of the installation bracket (using a 1/8" drill bit). Mount the mounting bracket with wood screws (DD) and Outlet Box Screw (BB).

## 2-2. Installation Method Two: Installation method of cement ceiling structure installation brackets.

① Drill the holes. (Use a 5/16" drill bit.)

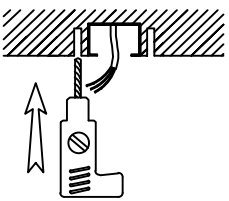

② Drive the anchor expansion bolt(CC) into the hole.

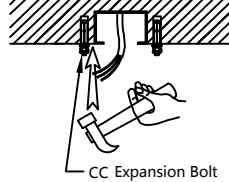

③ Tighten the hex nut(3) until the anchor expansion bolt(CC) is secure.

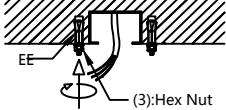

④ Remove (3), (2) and (1).

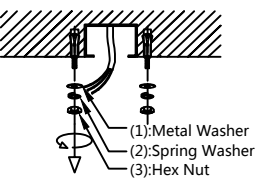

⑤ Attach the mounting bracket (A) onto the ceiling expansion bolt (CC). Fix with outlet box screw (BB), again fit in metal washer (1), spring washer (2), and tighten with the hex nut (3).

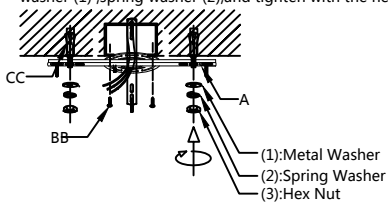

## 4. Connect the wires

STEP 1: Wrap the ground wire from the outlet box around the Ground Screw on the Mounting Bracket (A), and then connect the ground wire from the fixture to the ground wire from the outlet box.

STEP 2: Connect the wires from the fixture to the house supply wires, neutral (white) to neutral wire, and hot (black) to hot wire.

STEP 3: Spread apart the wires so that the hot wires are on one side of the outlet box and the neutral wires are on the other.

STEP 4: Push the screw Canopy (B) aligned with Mounting Bracket (A) to the ceiling, and use M5 nut (C) to fix Canopy (B) to the ceiling.

# INSTALL CRYSTAL AND BULBS

Schematic diagram of replacing the driver without disassembling the lamp

Ajuste de altura.

Unscrew the screws from the side of the ceiling panel, pull out the small drawer, and take out the driver for replacement.

Step 1: The light source is an LED light source and has been pre-installed.

Step 2: Install the crystal strip.

Schematic diagram of bubble column and light source installation and replacement.