

## IMPORTANT NOTE

1. PLACE ALL PARTS ON A CLEAN AND SMOOTH SURFACE SUCH AS A RUG OR CARPET TO AVOID THE PARTS FROM BEING SCRATCHED
2. BEFORE YOU BEGIN, KINDLY FOLLOW THE ASSEMBLY INSTRUCTIONS STEP BY STEP
3. DO NOT TIGHTEN ALL SCREWS AND BOLTS UNTIL THE CABINET IS FULLY SET-UP

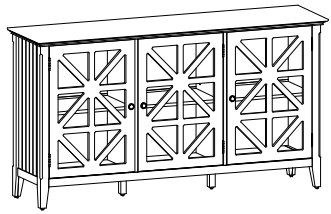

Recommendations Before Beginning Assembly

- Read instructions, cover to cover
- Have 2-4 adults on hand for assembly depending on product size
- Do not assemble directly on flooring or carpet
- Assemble on a clean non-marring surface (example: packing foam)
- Save all packaging until finished

Assembly Notice:

- If you encounter any problems during assembly and find that you cannot continue, rest assured we will help you solve the situation as soon as possible. Simply keep all of the parts of the product stored in a safe place and contact us immediately so we may assist you further.
- Once you have opened your package, remove all inner hardware packages and take the parts out. One by one, Place the parts out neatly in front of you, then refer to the instructions to ensure no parts are missing. If any pieces are found missing, please carefully look in the box first, as the hardware packaging might have torn making the hardware spill in the box.
- Some key parts of your product may be stored and hidden inside of other parts. Please open any zippered or hook & loop storage compartments to remove all parts. (example: cushions and legs being stored in the underside of a sofa)

It is **STRONGLY RECOMMENDED** that you **ANCHOR** this product. Toppling furniture can cause serious injuries and death. This product has not been fitted with an anchor strap. To prevent your furniture from tipping forward it is strongly recommended that you securely attach this product to a wall or other solid surface, using the anchor straps provided and appropriate fixings.

**IMPORTANT:** When setting up your product, **DO NOT INSTALL THE SCREWS ALL THE WAY IN THE BEGINNING.** Place each screw into their proper hole and use your hand to twist the screw halfway. Twist all the screws in halfway to ensure the holes will match up properly and the product is level on the ground. When everything seems fitted, then tighten the screws.

- When you have completed assembly, we suggest you have more than one person to assist you with lifting and placing the product.

This product contains small components. Please ensure that they are kept away from small children. Do not use power tools to assemble your furniture. Power tools may strip or damage the parts.

Thank you for choosing our products.

Return Policy

**DO NOT RETURN TO THE STORE!**

Skip the process of returning your product and contact us directly for a replacement









If your product's quality does not meet your expectations or you have found any sort of defect, please contact our customer service department and let us know the details of your order and any issues encountered, we will try our best to provide you with a solution.

Care & Maintenance

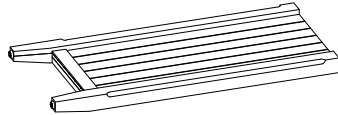
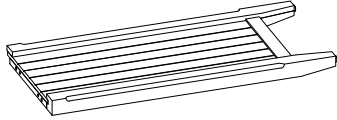
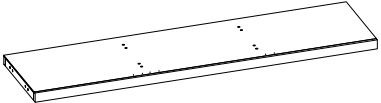
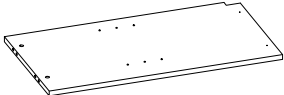
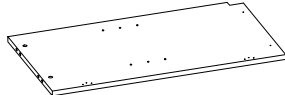

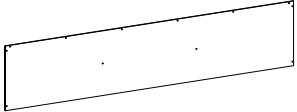

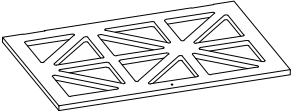
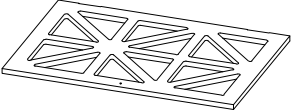
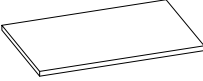



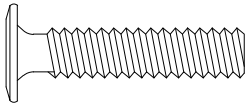
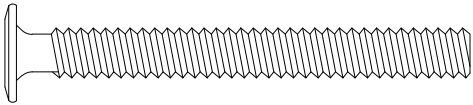

- Do not put hot items directly on furniture surface
- Do not clean furniture with harsh cleansers or polish
- Do not place furniture under direct sunlight
- Do not place furniture near heating or cooling vents
- Do not write on furniture without a padded barrier to protect the surface
- Do not place furniture outside. For indoor use only
- Not for commercial use. For residential use only
- Stains may be removed with mild soap solution and damp cloth
- Children should not climb or jump on the furniture
- Dust and pick-up spills using a clean, non-colored, lint-free cloth

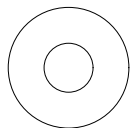
# ASSEMBLY INSTRUCTION

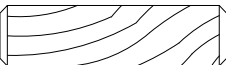
## PART LIST

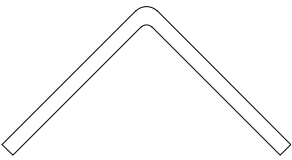
<p>A</p>  <p>TOP (1PC)</p>	<p>B</p>  <p>SUPPORT RAIL (1PC)</p>	<p>C1</p>  <p>SIDE FRAME LEFT (1PC)</p>	<p>C2</p>  <p>SIDE FRAME RIGHT (1PC)</p>
<p>D</p>  <p>BOTTOM FRAME (1PC)</p>	<p>E1</p>  <p>CENTER PANEL LEFT (1PC)</p>	<p>E2</p>  <p>CENTER PANEL RIGHT (1PC)</p>	<p>F</p>  <p>CENTER LEGS (2PCS)</p>
<p>G</p>  <p>BACK PANEL (2PCS)</p>	<p>H1</p>  <p>CENTER H - RAIL (2PC)</p>	<p>H2</p>  <p>SIDE H - RAIL (1PCS)</p>	<p>I1</p>  <p>DOOR LEFT (1PC)</p>
<p>I2</p>  <p>DOOR RIGHT (2PCS)</p>	<p>K1</p>  <p>SIDE SHELF (2PCS)</p>	<p>K2</p>  <p>CENTER SHELF (1PC)</p>	

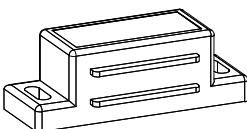
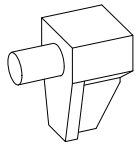
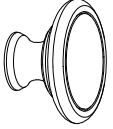

## HARDWARE LIST

<p>1</p>  <p>ALLEN KEY (1PC) K4 x 60 mm</p>	<p>2</p>  <p>HEX HEAD BOLT (8PCS) 1/4 x 30 mm</p>	<p>3</p>  <p>HEX HEAD BOLT (4PCS) 1/4 x 60 mm</p>	<p>4</p>  <p>SPRING WASHER (12PCS) 1.2 x Ø6.5 x 11 mm</p>
<p>5</p>  <p>FLAT WASHER (12PCS) 1.2 x Ø6.5 x 16 mm</p>	<p>6</p>  <p>BARREL NUT (4PCS) 1/4 x Ø10 x 10 mm</p>	<p>7</p>  <p>WOOD DOWEL (19PCS) Ø8 x 30 mm</p>	<p>8</p>  <p>WOOD SCREW (6PCS) Ø4 x 40 mm</p>
<p>9</p>  <p>V - BRACKET (4PCS) 2 x 15 x 27 mm</p>	<p>10</p>  <p>WOOD SCREW (38PCS) Ø3.5 x 15 mm</p>	<p>11</p>  <p>WOOD SCREW (24PCS) Ø3.5 x 15 mm</p>	<p>12</p>  <p>DOOR STOPPER (6PCS) 13 x 15 x 45 mm</p>
<p>13</p>  <p>SHELF PIN (12PCS)</p>	<p>14</p>  <p>HANDLE (3PCS)</p>	<p>15</p>  <p>BOLT (3PCS) M4 x 20 mm</p>	

# ASSEMBLY INSTRUCTION

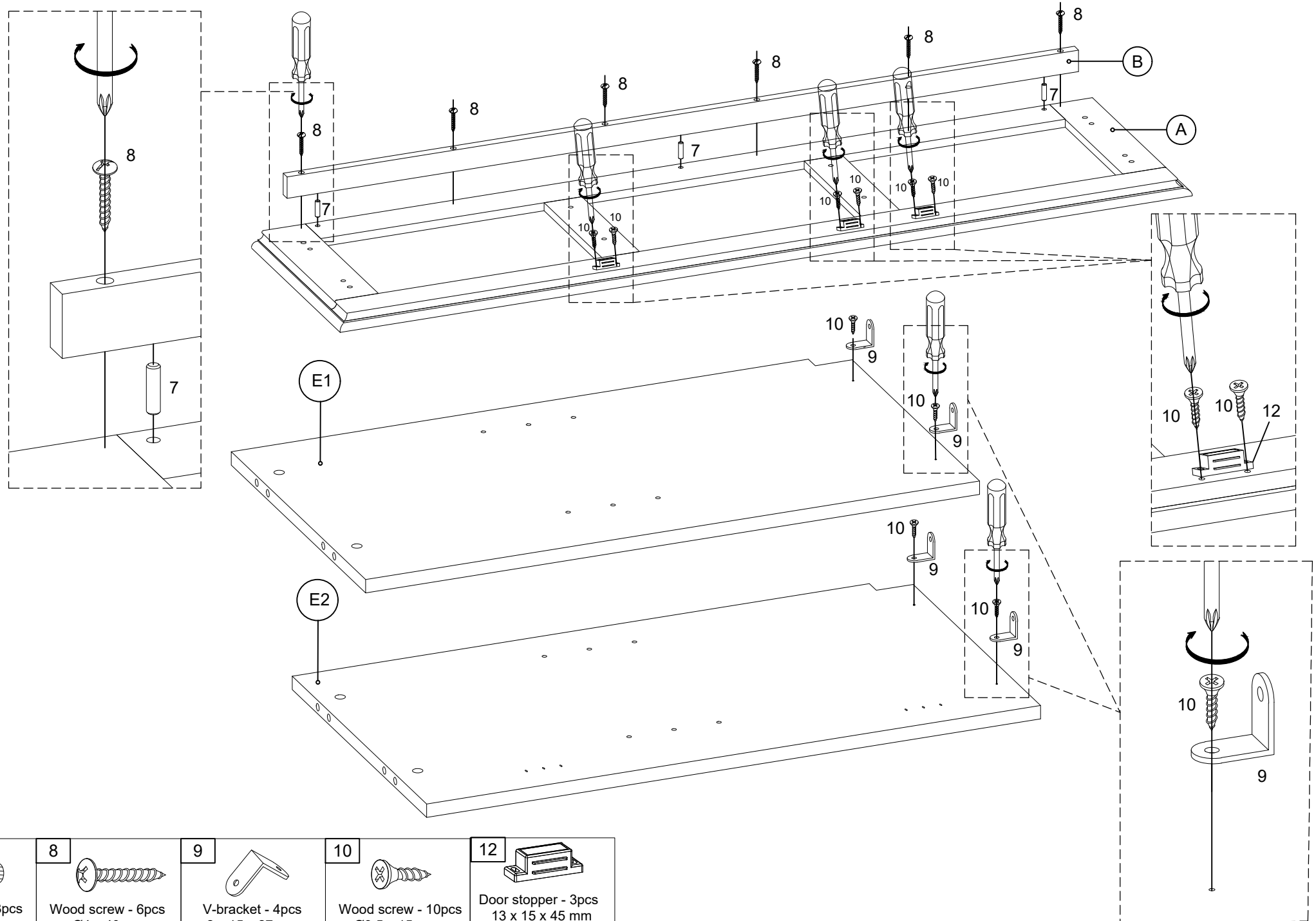
STEP 1

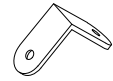
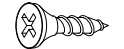
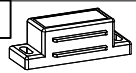

7		8		9		10		12	
Wood dowel - 3pcs Ø8 x 30 mm		Wood screw - 6pcs Ø4 x 40 mm		V-bracket - 4pcs 2 x 15 x 27 mm		Wood screw - 10pcs Ø3.5 x 15 mm		Door stopper - 3pcs 13 x 15 x 45 mm	



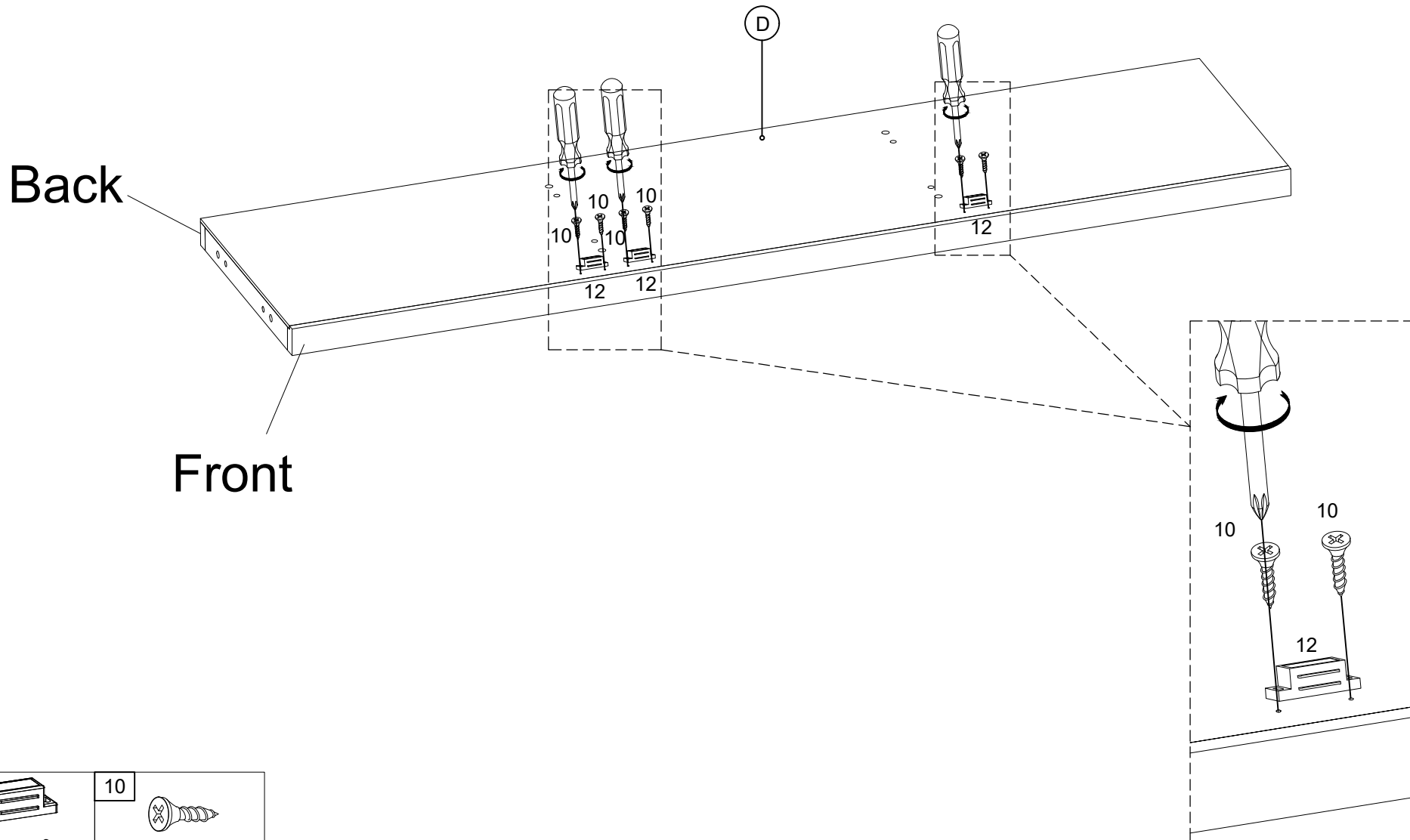

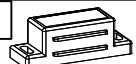
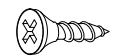
STEP 2

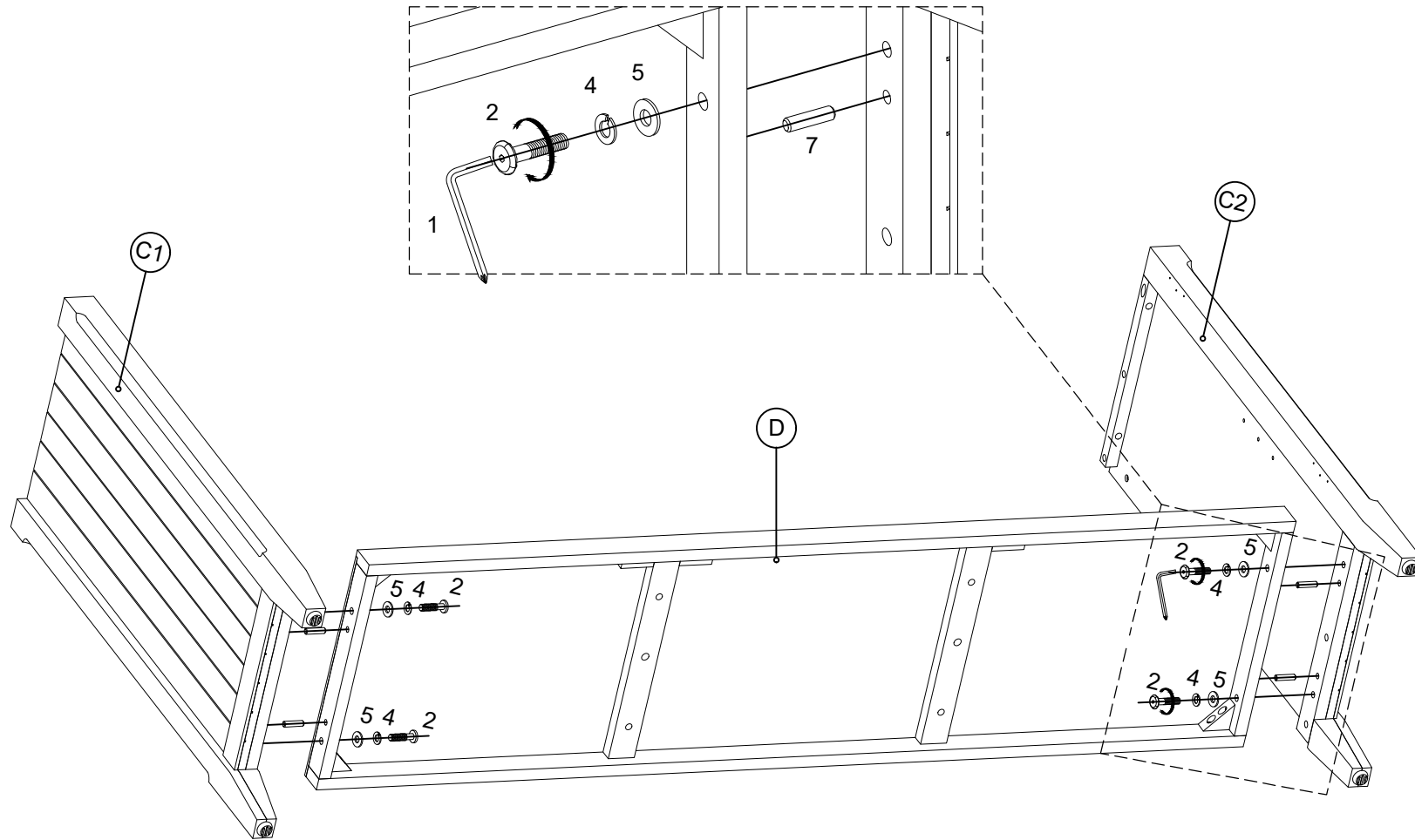

12 	10 
Door stopper - 3pcs 13 x 15 x 45 mm	Wood screw - 6pcs Ø3.5 x 15 mm

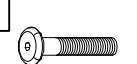





STEP 3

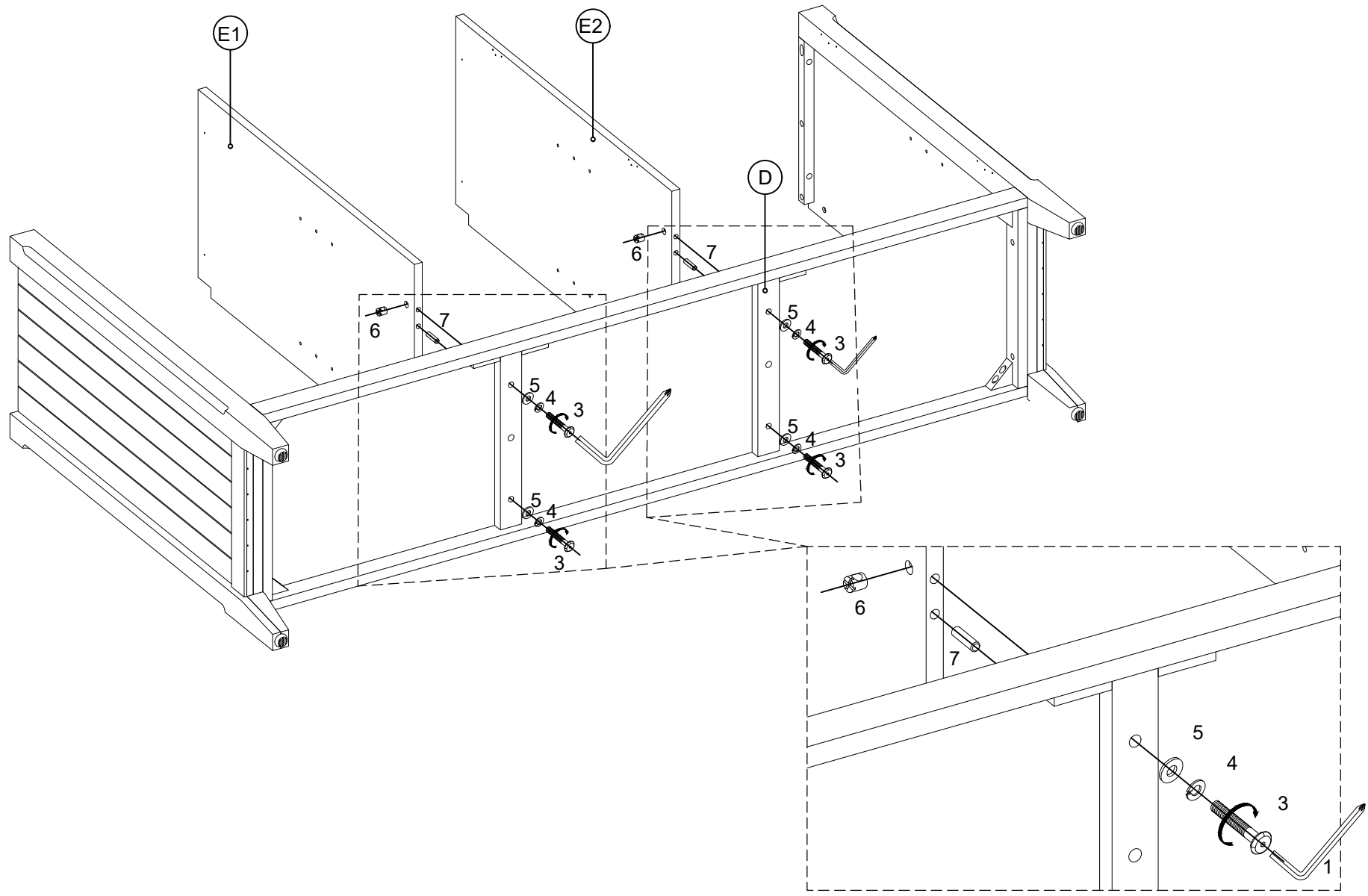

1		2		4		5		7	
Allen key - 1pc K4 x 60 mm	Hex head bolt - 4pcs 1/4 x 30 mm	Spring washer - 4pcs 1.2 x Ø6.5 x 11 mm	Flat washer - 4pcs 1.2 x Ø6.5 x 16 mm	Wood dowel - 4pcs Ø8 x 30 mm					



STEP 4

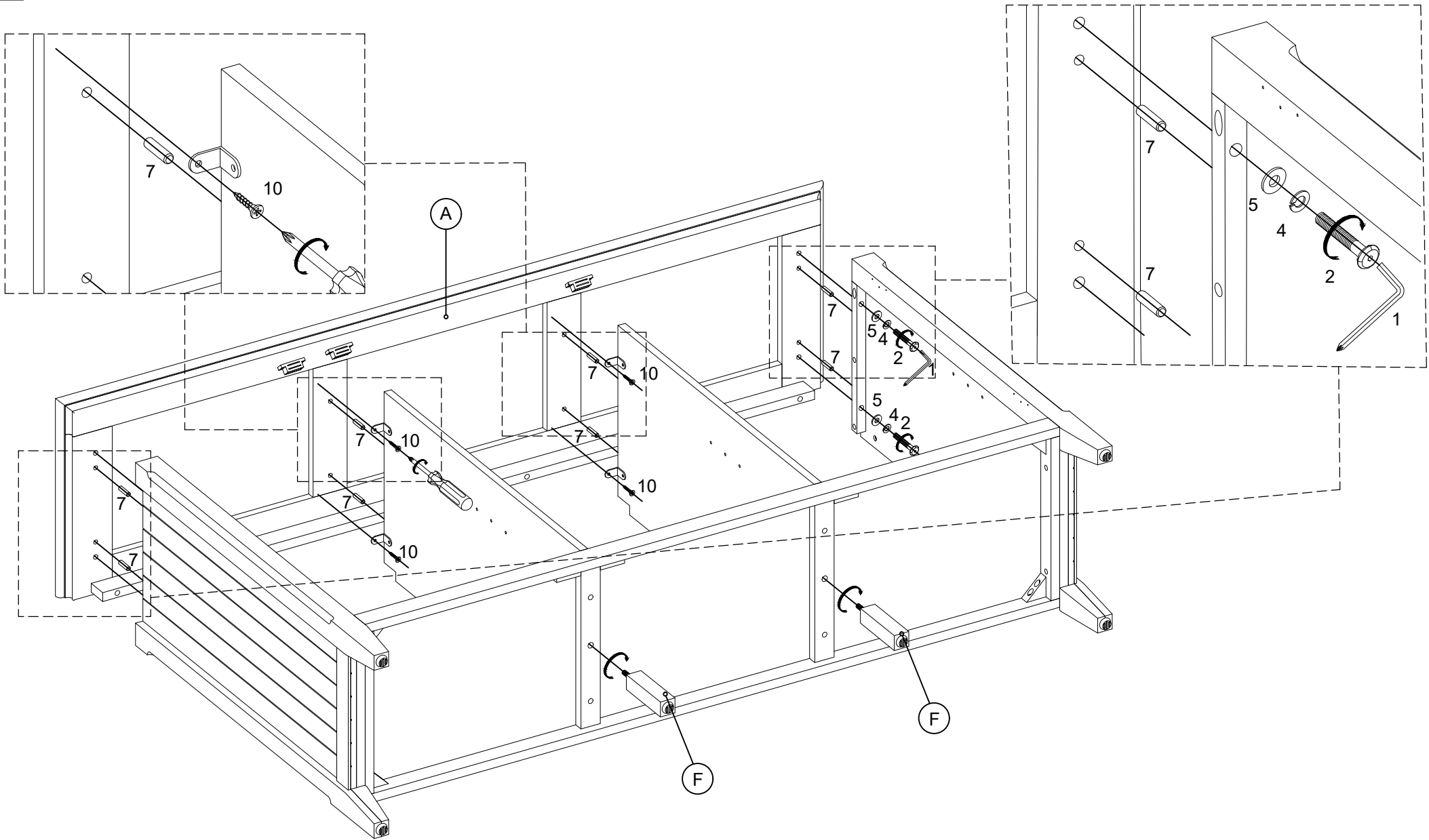

<p>1</p> 	<p>3</p> 	<p>4</p> 	<p>5</p> 	<p>6</p> 	<p>7</p> 
<p>Allen key - 1pc K4 x 60 mm</p>	<p>Hex head bolt - 4pcs 1/4 x 60 mm</p>	<p>Spring washer - 4pcs 1.2 x Ø6.5 x 11 mm</p>	<p>Flat washer - 4pcs 1.2 x Ø6.5 x 16 mm</p>	<p>Barrel nut - 4pcs 1/4 x Ø10 x 10 mm</p>	<p>Wood dowel - 4pcs Ø8 x 30 mm</p>

STEP 5

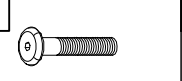

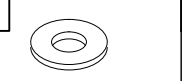
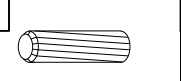
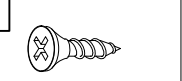
<p>1</p> 	<p>2</p> 	<p>4</p> 	<p>5</p> 	<p>7</p> 	<p>10</p> 
<p>Allen key - 1pc K4 x 60 mm</p>	<p>Hex head bolt - 4pcs 1/4 x 30 mm</p>	<p>Spring washer - 4pcs 1.2 x Ø6.5 x 11 mm</p>	<p>Flat washer - 4pcs 1.2 x Ø6.5 x 16 mm</p>	<p>Wood dowel - 8pcs Ø8 x 30 mm</p>	<p>Wood screw - 4pcs Ø3.5 x 15 mm</p>

STEP 6

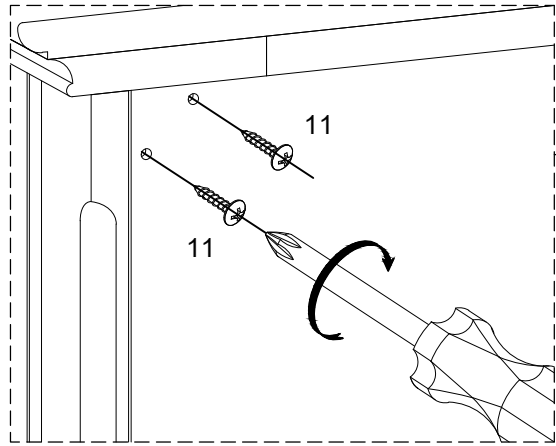
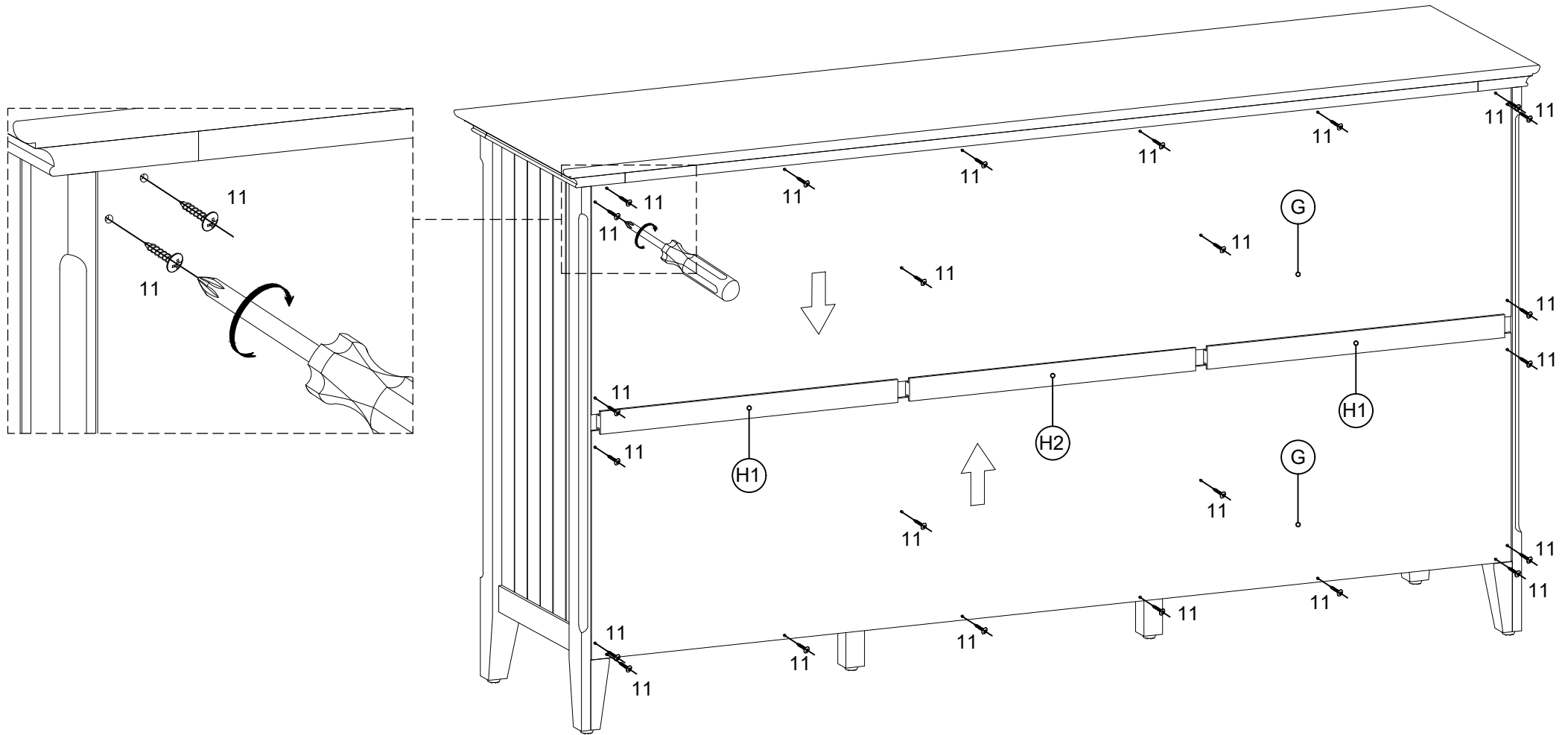

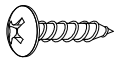

11

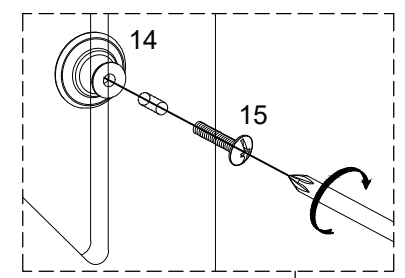
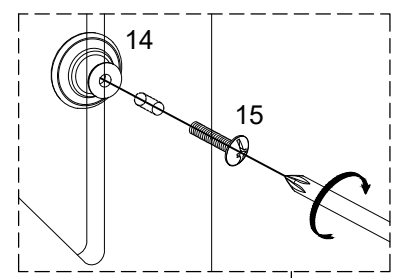
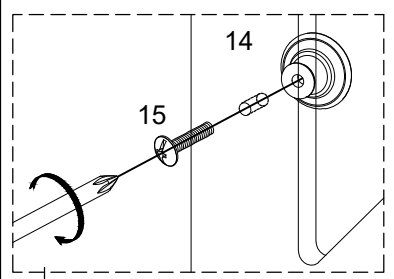
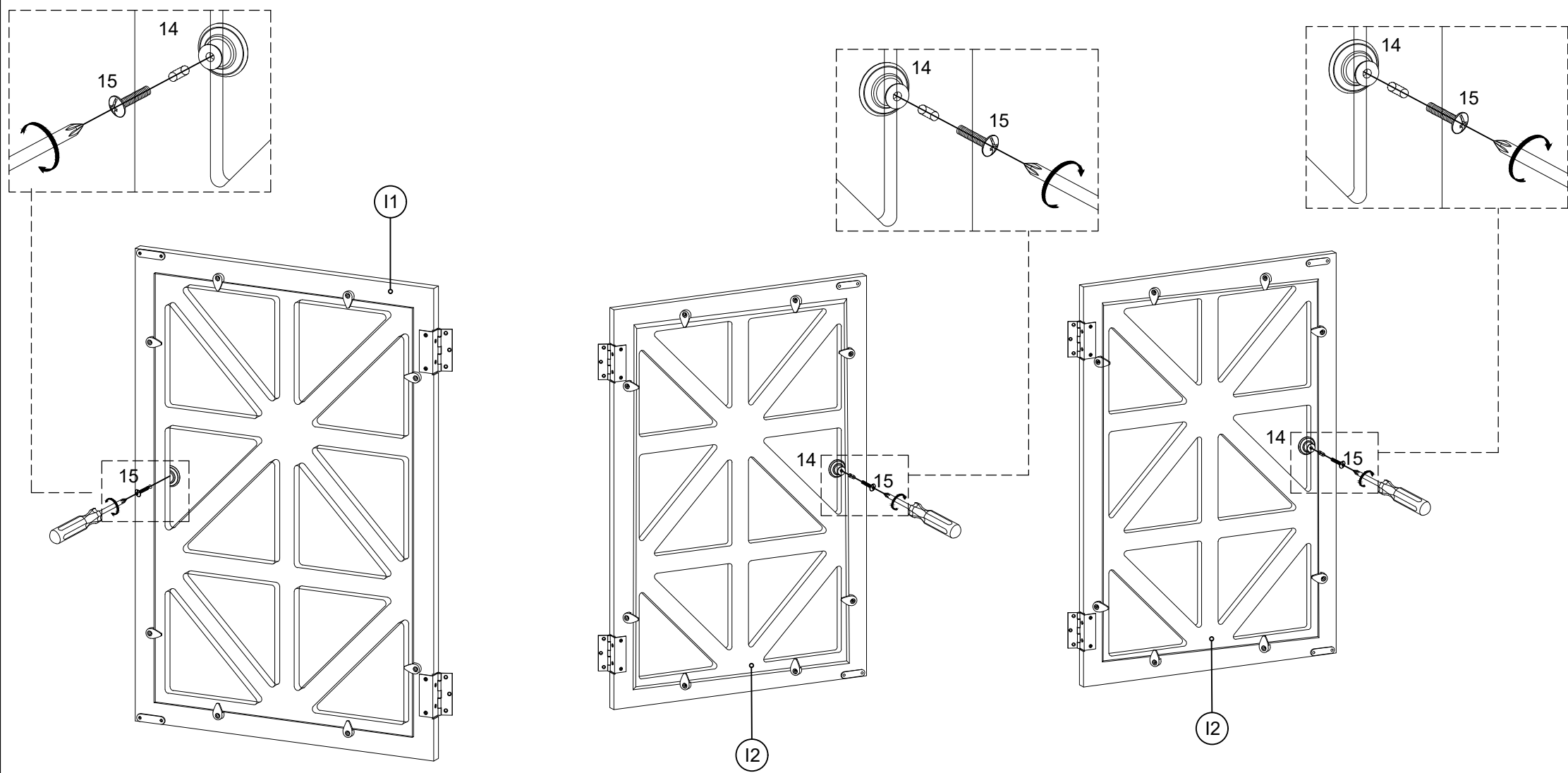

Wood screw - 24pcs  
Ø3.5 x 15 mm

STEP 7

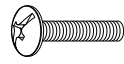

14 	15 
Handle - 3pcs	Bolt - 3pcs M4 x 20 mm

STEP 8

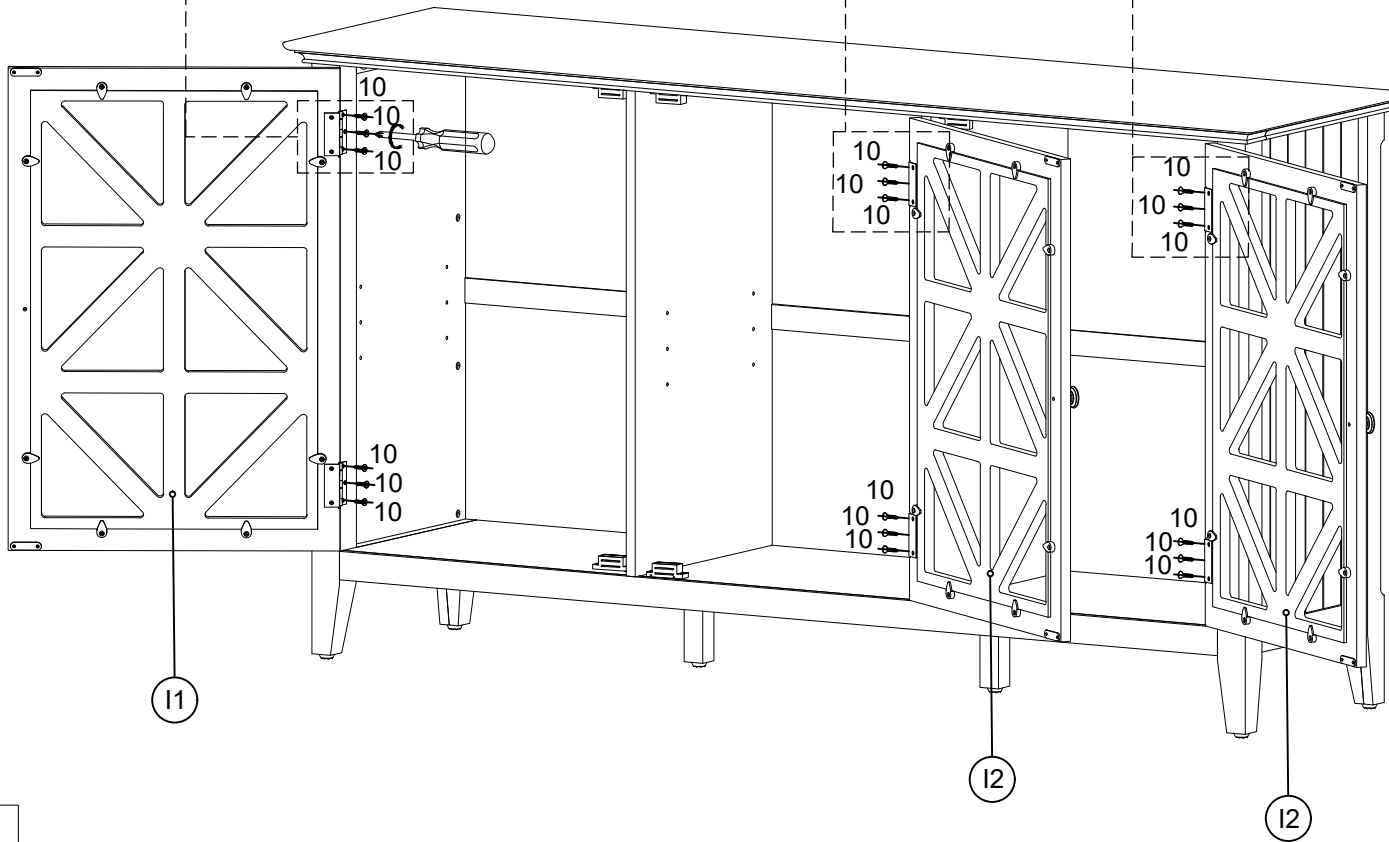
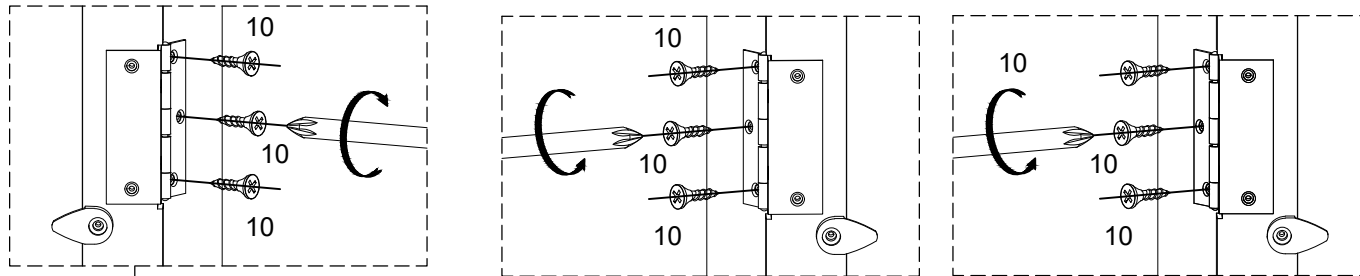

10



Wood screw - 18 pcs  
Ø3.5 x 15 mm

STEP 9

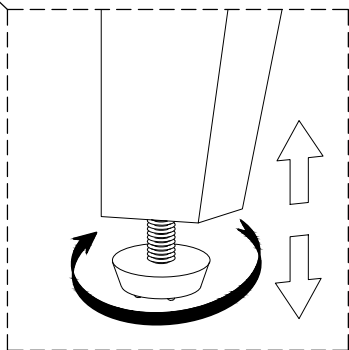
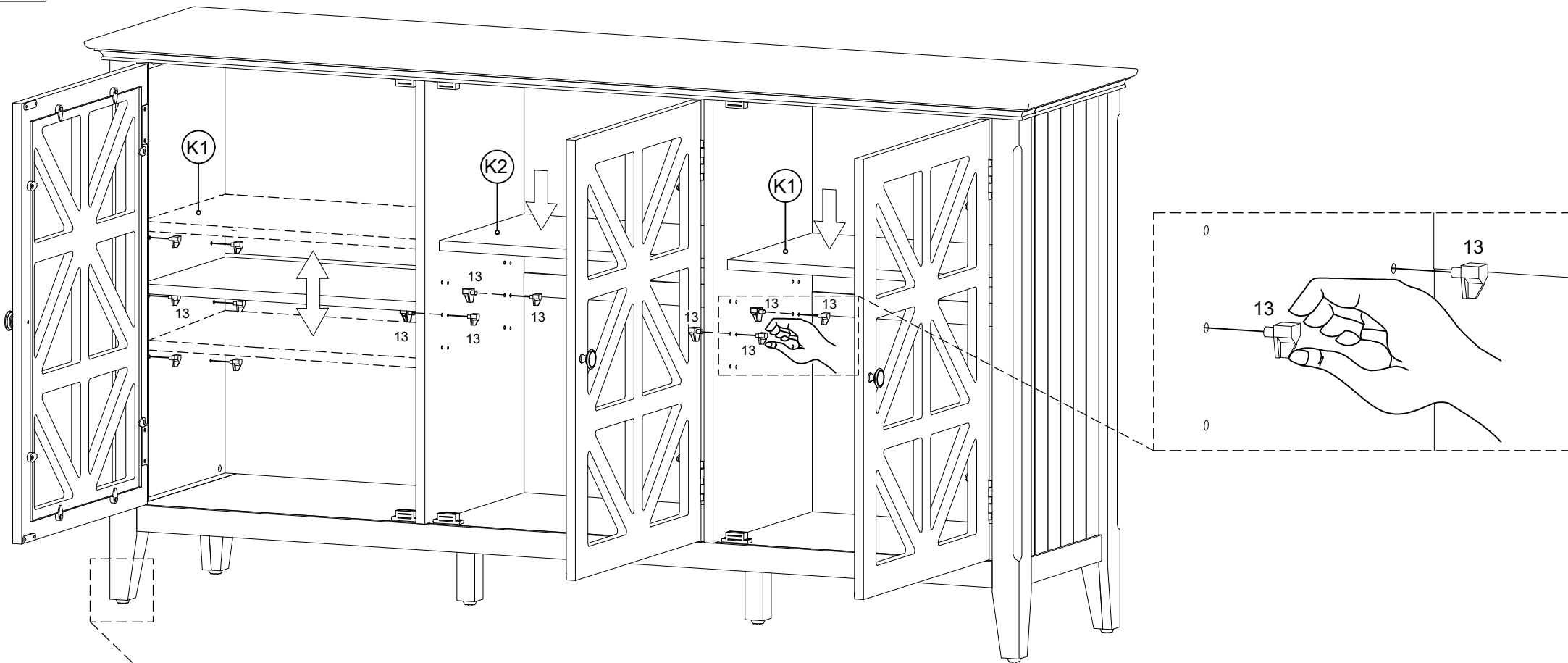

moving up and down the adjustable panel to adjust its height by moving the pin position follow the step 9.

13



Shelf pin - 12pcs