

Model No.: HVD02

INSTRUCTION MANUAL

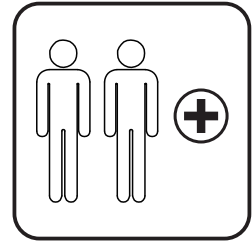
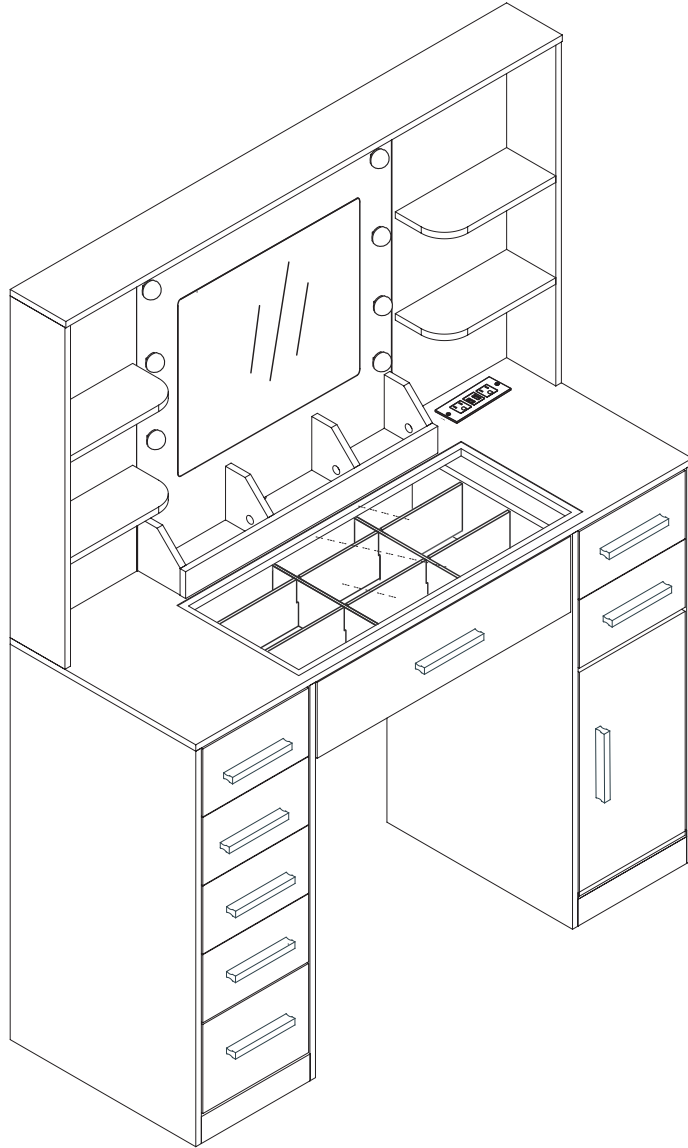

Size: 110*40*135cm

Customer service is here to assist you all the time.
Please contact us and Leave ordernumber if you have difficulty
with installing or need replacement parts.

- Important, retain for future reference: read carefully
- Wichtig, für spätere nachschlage aufbewahren: sorgfältig lesen
- Importante, guardar para referencia futura: leer atentamente
- Importante, conservare per riferimenti futuri: leggere attentamente
- Important, à conserver pour référence future : lire attentivement

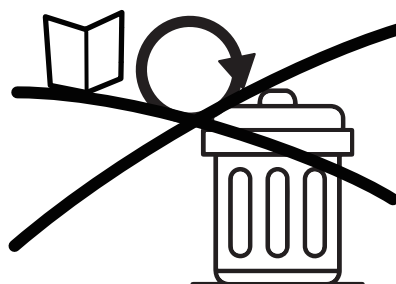
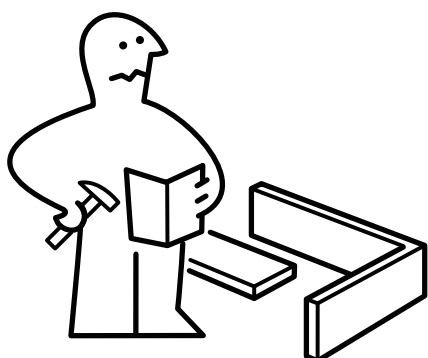

- Assemble on a flat, clean and soft surface.
- Auf einer flachen, sauberen und weichen Oberfläche zusammenbauen.
- Assembler sur une surface plate, propre et douce.
- Assemblare su una superficie piatta, pulita e morbida.
- Ensamblar sobre una superficie plana, limpia y suave.

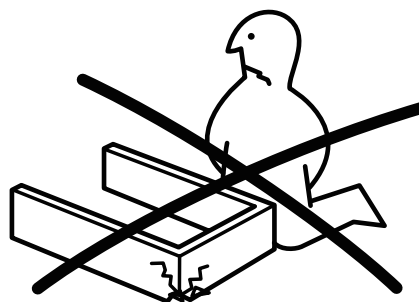
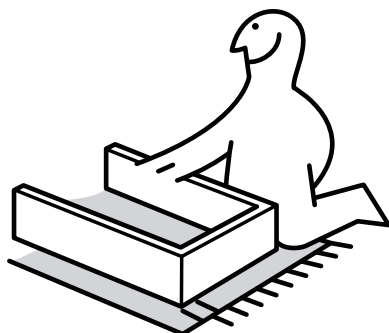

- Professional installation is highly recommended.
- Eine professionelle Installation wird dringend empfohlen.
- Une installation professionnelle est fortement recommandée.
- Si raccomanda vivamente l'installazione professionale.
- Se recomienda altamente la instalación profesional.



- Periodically check that all components are tightly secured.
- Überprüfen sie regelmäßig, dass alle komponenten fest gesichert sind.
- Vérifiez périodiquement que tous les composants sont bien fixés.
- Controllare periodicamente che tutti i componenti siano ben fissati.
- Verifique periódicamente que todos los componentes estén bien asegurados.



- It is recommended that multiple people assemble this product.
- Es wird empfohlen, dass mehrere Personen dieses Produkt zusammenbauen.
- Il est recommandé que plusieurs personnes assemblent ce produit.
- Si raccomanda che più persone assemblino questo prodotto.
- Se recomienda que varias personas ensamben este producto.

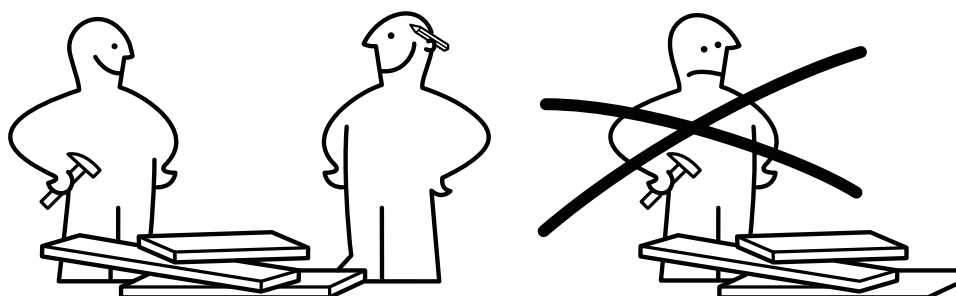

- Please have the following auxiliary tools ready:
- Bitte haben Sie die folgenden Hilfswerkzeuge bereit:
- Veuillez avoir les outils auxiliaires suivants à portée de main:
- Si prega di avere pronti i seguenti strumenti ausiliari:
- Por favor, tenga listos las siguientes herramientas auxiliares:

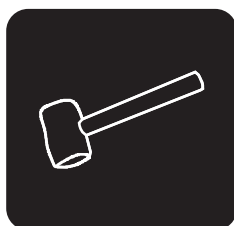
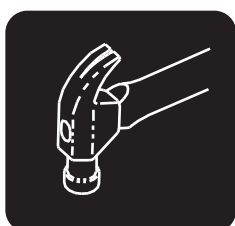

- Serious or fatal crushing injuries can occur due to furniture tip-over. Always secure this furniture to the wall with tip-over restraints.
- Schwere oder tödliche Quetschverletzungen können durch das Umkippen von Möbeln verursacht werden. Sichern Sie diese Möbel immer mit Kipp-Sicherungen an der Wand.
- Des blessures graves ou mortelles par écrasement peuvent survenir lors du basculement de meubles. Fixez toujours ces meubles au mur avec des dispositifs anti-basculement.
- Lesioni gravi o mortali da schiacciamento possono verificarsi a causa del ribaltamento dei mobili. Fissare sempre questi mobili alla parete con i sistemi antiribaltamento.
- Pueden ocurrir lesiones graves o fatales por aplastamiento por el volcamiento de muebles. Asegure siempre este mueble a la pared con dispositivos anti-vuelco.

- Never let children climb or hang on drawers, doors, or shelves.
- Lassen Sie Kinder niemals auf Schubladen, Türen oder Regalen klettern oder hängen.
- Ne laissez jamais les enfants grimper ou se suspendre aux tiroirs, portes ou étagères.
- Non permettere mai ai bambini di arrampicarsi o appendersi ai cassetti, alle porte o agli scaffali.
- Nunca permita que los niños trepen o se cuelguen de los cajones, puertas o estantes.

How to use furniture connector cam lock screw and fitting?

Eccentric wheel(A)

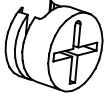

Dowel(B)



1

Use screwdriver to attach
dowel into pre-inserted nut

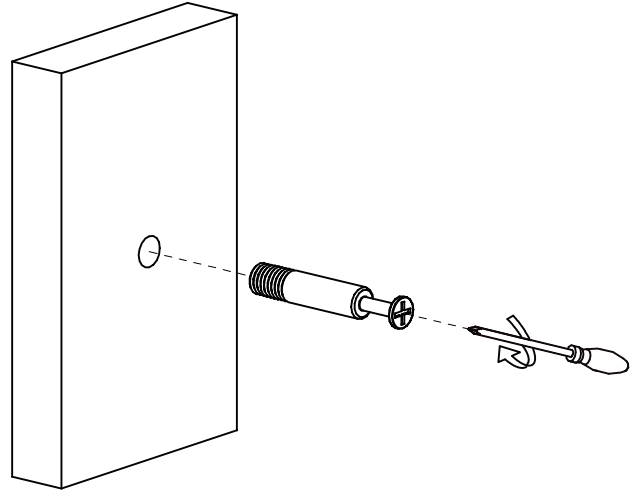

2

Step 1 completed

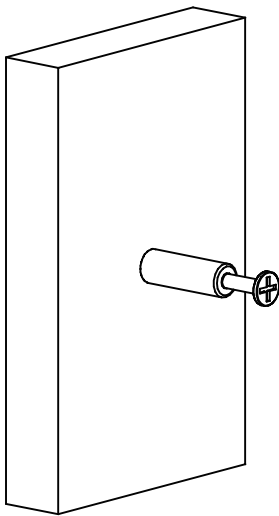

3

Attach dowel into hole on fitting board

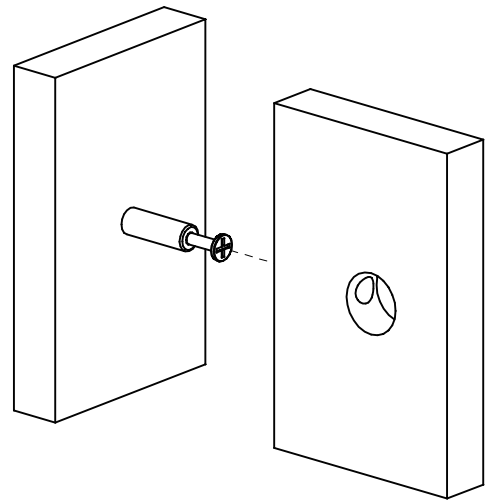

4

Put eccentric wheel (cam lock fitting) into hole

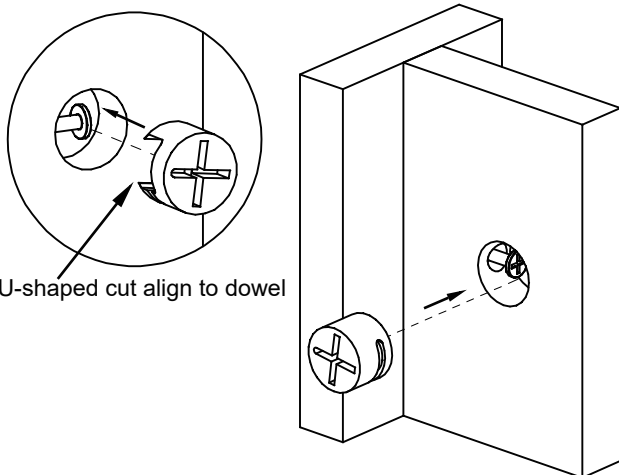

5

Tighten: Turn the eccentric wheel clockwise
Loosen: Turn it anticlockwise

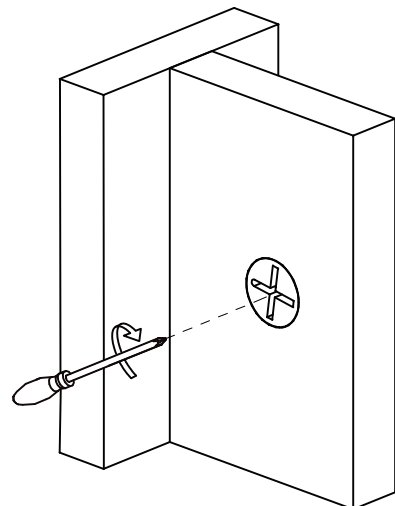

Slide rail specifications

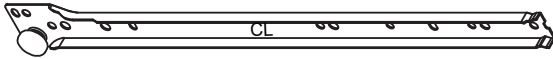

CL
x8
L300mm



CR
x8
L300mm

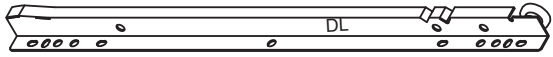



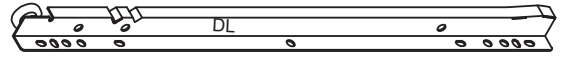





DL
x8
L300mm

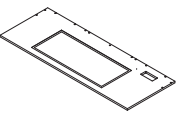

DR
x8
L300mm

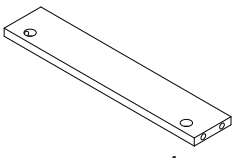
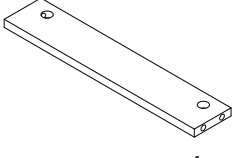
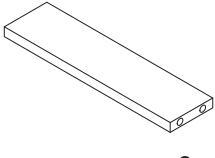
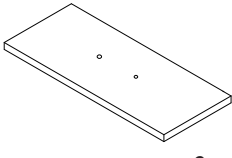
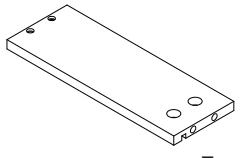
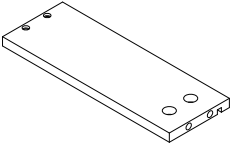
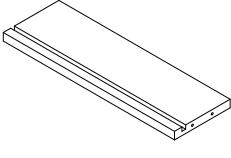
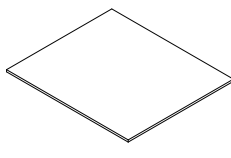
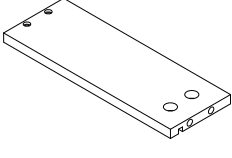
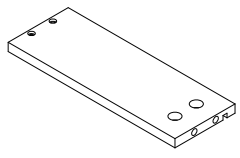
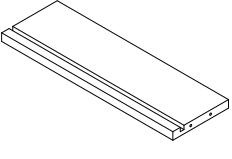
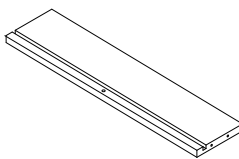
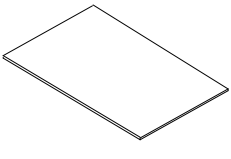
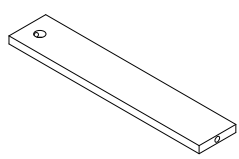
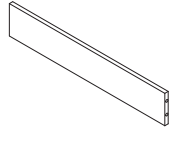
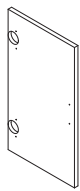
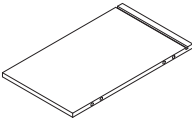
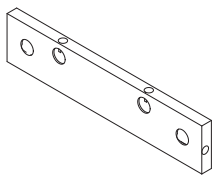
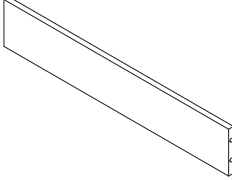
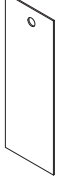

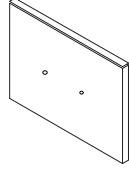
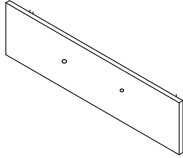
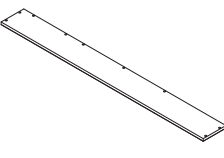
List Of Installation Parts

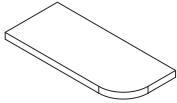
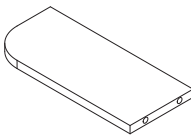
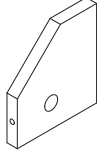
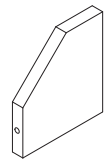
● Before installation, please check all parts for any missing components.

<p>1 1100X400X12MM</p>  <p>1pcs</p>	<p>2 738X398X12MM</p>  <p>1pcs</p>	<p>3 738X398X12MM</p>  <p>1pcs</p>	<p>4 738X398X12MM</p>  <p>1pcs</p>	<p>5 738X398X12MM</p>  <p>1pcs</p>
<p>6 246X50X12MM</p>  <p>1pcs</p>	<p>7 246X50X12MM</p>  <p>1pcs</p>	<p>8 246X60X12MM</p>  <p>2pcs</p>	<p>9 240X127X12MM</p>  <p>6pcs</p>	<p>10 300X100X12MM</p>  <p>7pcs</p>
<p>11 300X100X12MM</p>  <p>7pcs</p>	<p>12 198X100X12MM</p>  <p>6pcs</p>	<p>13 206X295X3MM</p>  <p>7pcs</p>	<p>14 300X120X12MM</p>  <p>1pcs</p>	<p>15 300X120X12MM</p>  <p>1pcs</p>
<p>16 198X120X12MM</p>  <p>1pcs</p>	<p>17 510X100X12MM</p>  <p>1pcs</p>	<p>18 518X295X3MM</p>  <p>1pcs</p>	<p>19 287X50X12MM</p>  <p>1pcs</p>	<p>20 558X80X12MM</p>  <p>1pcs</p>
<p>21 440X240X12MM</p>  <p>1pcs</p>	<p>22 383X246X12MM</p>  <p>1pcs</p>	<p>23 246X50X12MM</p>  <p>2pcs</p>	<p>24 558X100X12MM</p>  <p>2pcs</p>	<p>25 684X254X3MM</p>  <p>1pcs</p>
<p>26 696X254X3MM</p>  <p>1pcs</p>	<p>27 240X180X12MM</p>  <p>1pcs</p>	<p>28 552X127X12MM</p>  <p>1pcs</p>	<p>29 1100X120X12MM</p>  <p>1pcs</p>	<p>30 588X118X12MM</p>  <p>1pcs</p>
<p>31 588X118X12MM</p>  <p>1pcs</p>	<p>32 250X104X12MM</p>  <p>2pcs</p>	<p>33 250X104X12MM</p>  <p>2pcs</p>	<p>34 100X92X12MM</p>  <p>3pcs</p>	<p>35 100X92X12MM</p>  <p>1pcs</p>



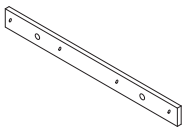
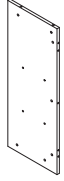
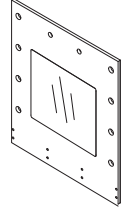

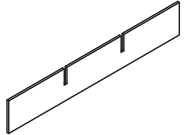
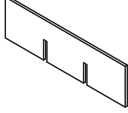

List Of Installation Parts

● Before installation, please check all parts for any missing components.

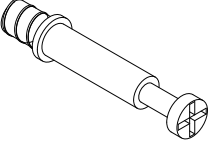
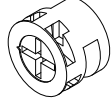
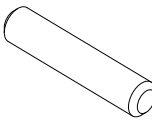
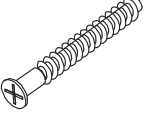
<p>36 570X50X12MM</p>  <p>1pcs</p>	<p>37 588X252X12MM</p>  <p>1pcs</p>	<p>38 588X570X12MM</p>  <p>1pcs</p>	<p>39 588X252X12MM</p>  <p>1pcs</p>
<p>40 508X84X5MM</p>  <p>2pcs</p>	<p>41 285X84X5MM</p>  <p>2pcs</p>		

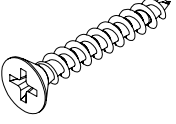
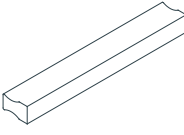
List Of Installation Parts

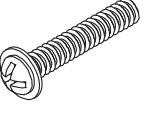
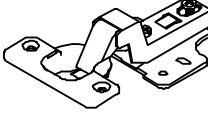
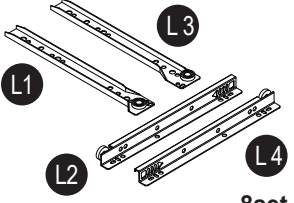
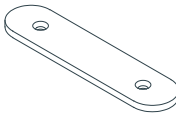
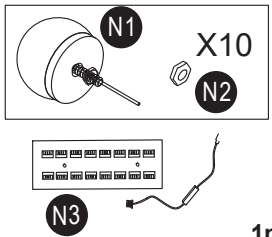
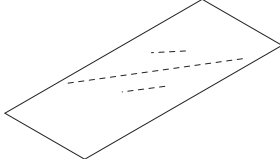
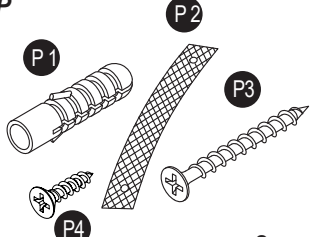
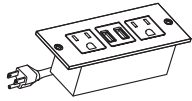
● Before installation, please check all parts for any missing components.

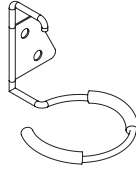
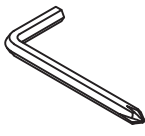
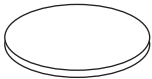
<p>A M6 X 35MM</p>  <p>100+2pcs</p>	<p>B M15 X 9.5MM</p>  <p>100+2pcs</p>	<p>C M6 X 30MM</p>  <p>35+2pcs</p>	<p>D M5 X 40MM</p>  <p>28+2pcs</p>
<p>E M3.5 X 12MM</p>  <p>30+2PCS</p>	<p>F M3.5 X 35MM</p>  <p>33+2pcs</p>	<p>G</p>  <p>9pcs</p>	<p>H M3*14MM</p>  <p>12+1pcs</p>
<p>I M3 X 12MM</p>  <p>64+2pcs</p>	<p>J M4 X 14MM</p>  <p>18+1pcs</p>	<p>K</p>  <p>2pcs</p>	<p>L</p>  <p>8set</p>
<p>M</p>  <p>6PCS</p>	<p>N</p>  <p>1pcs</p>	<p>O</p>  <p>1pcs</p>	<p>P</p>  <p>2pcs</p>
<p>Q</p>  <p>1pcs</p>	<p>R</p>  <p>12+1pcs</p>	<p>S</p>  <p>1pcs</p>	<p>T</p>  <p>1pcs</p>
<p>U</p>  <p>12+1pcs</p>			

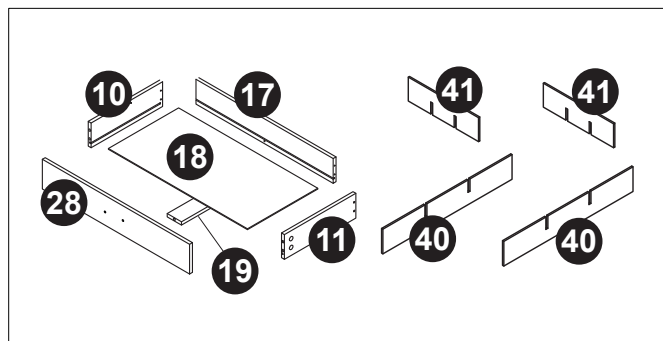
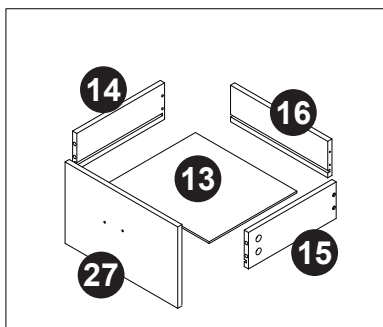
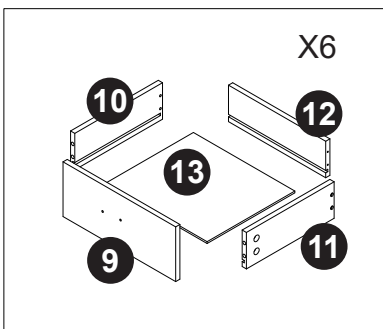
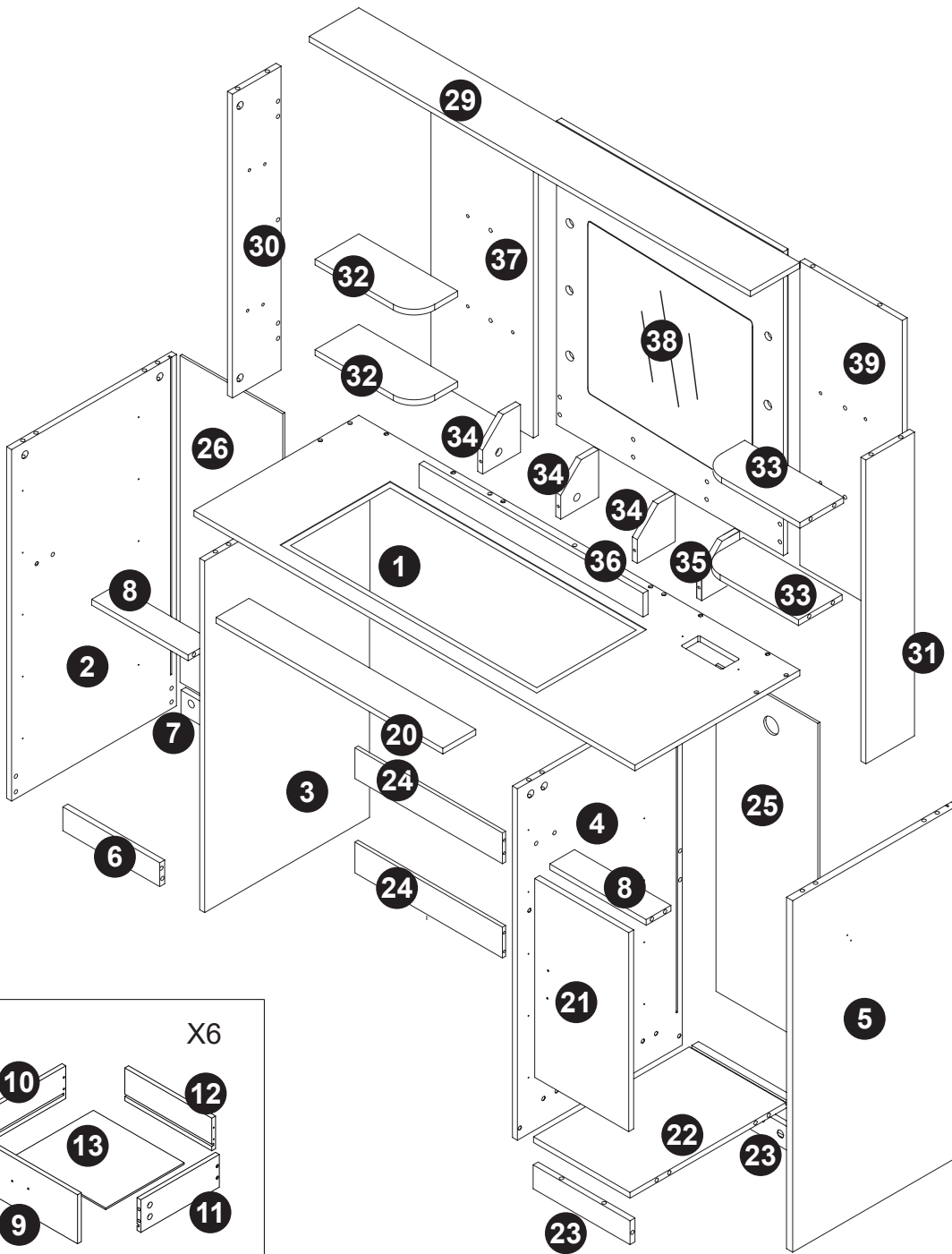

Step:1

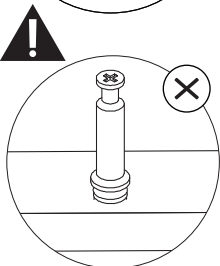
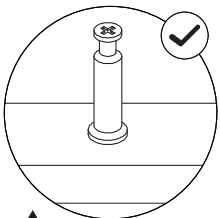
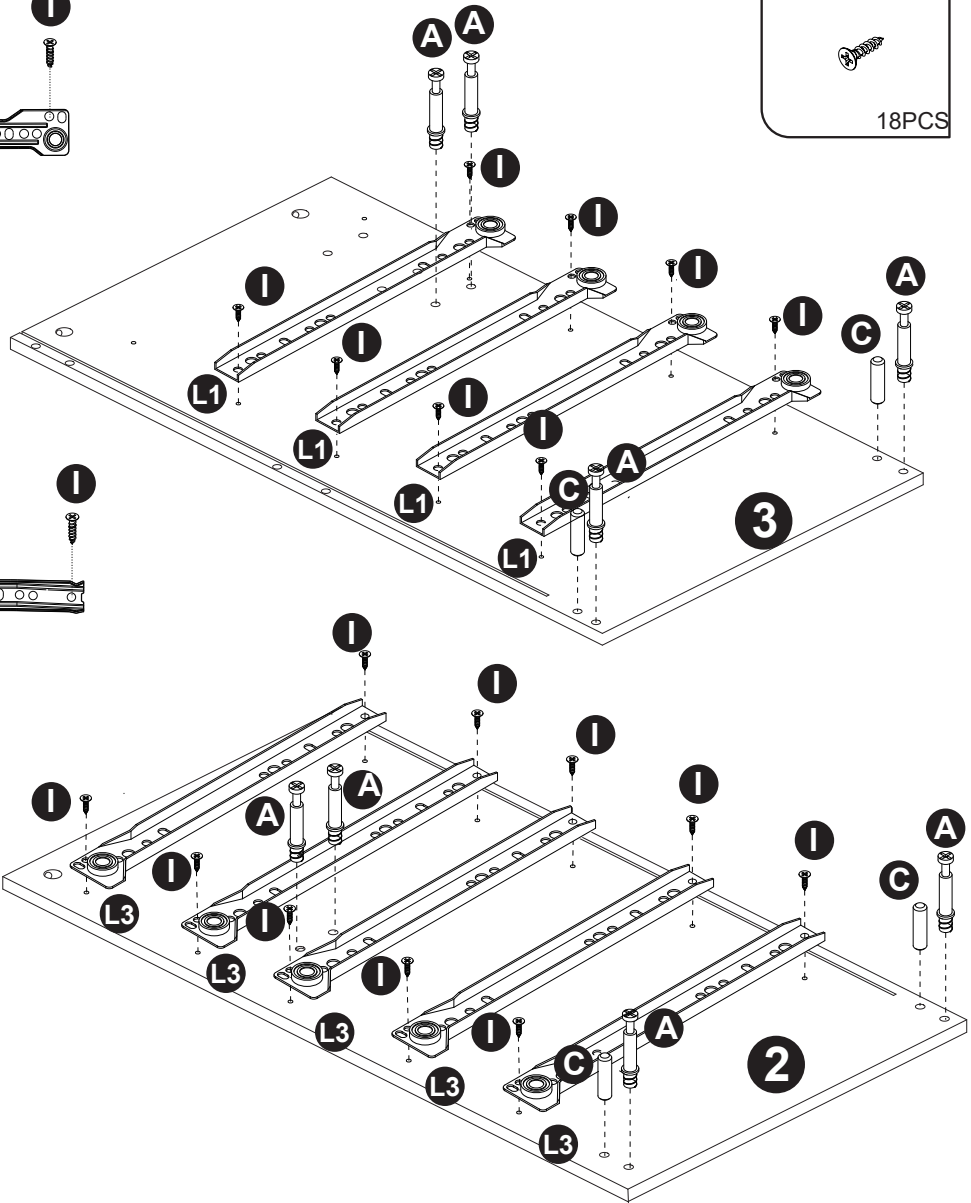
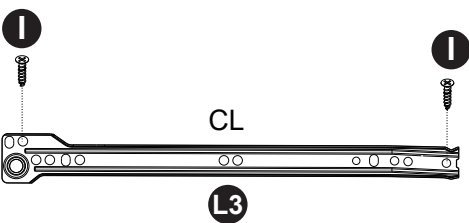
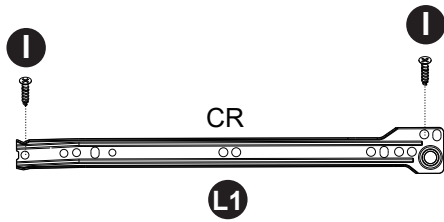
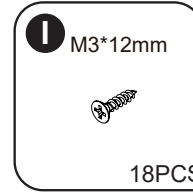
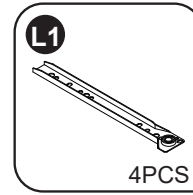
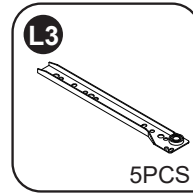
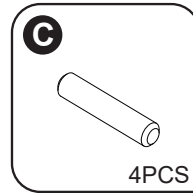
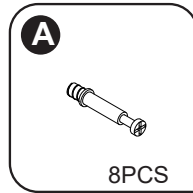
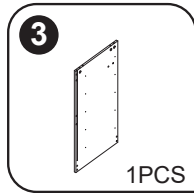
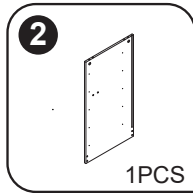

Step:2

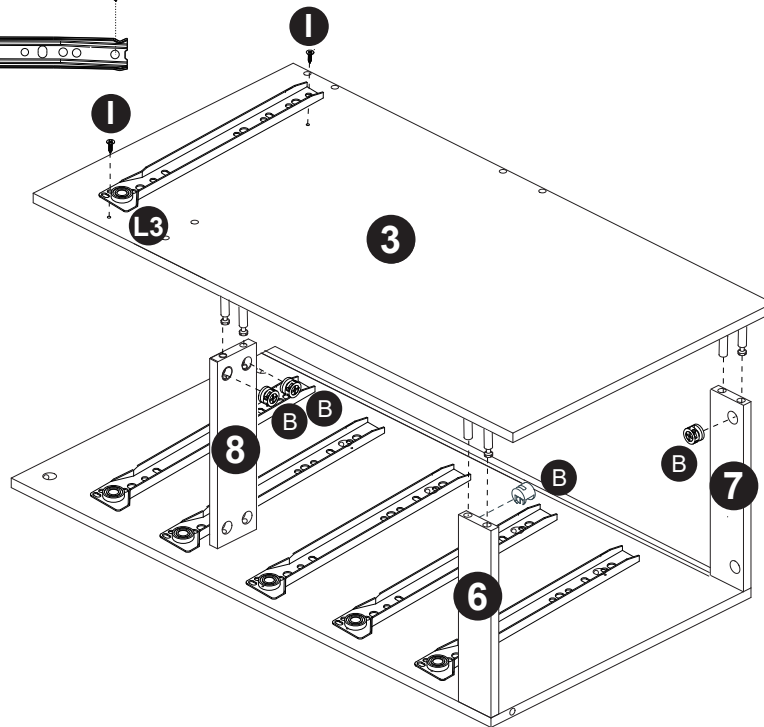
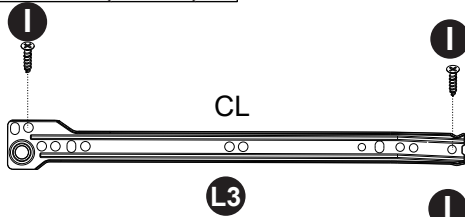
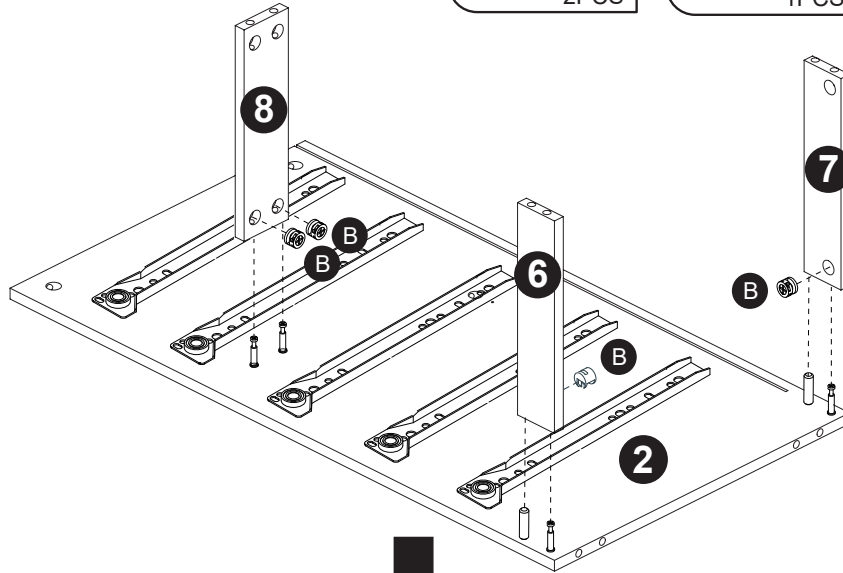
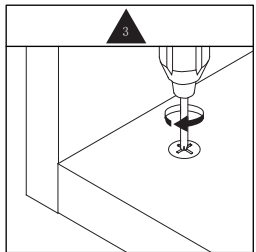
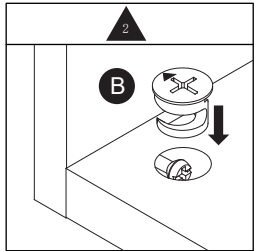
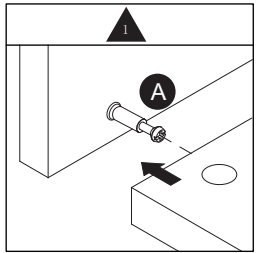
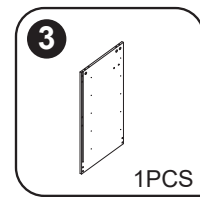
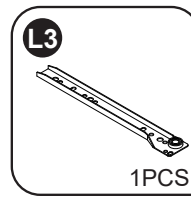
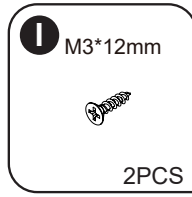
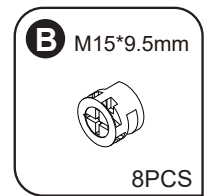
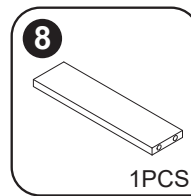
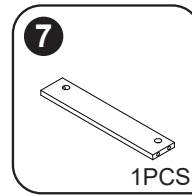
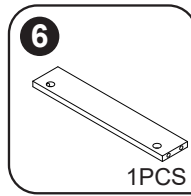

Step:3

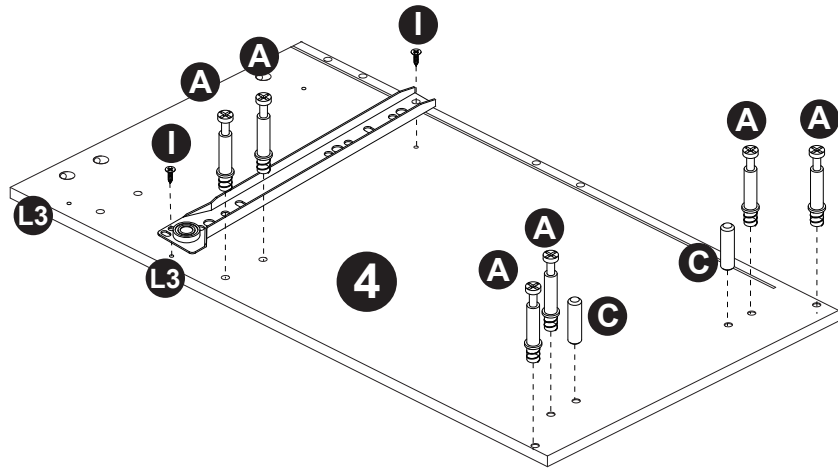
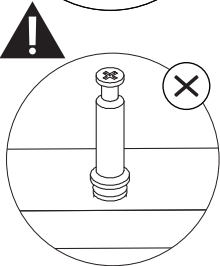
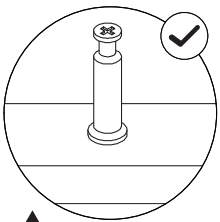
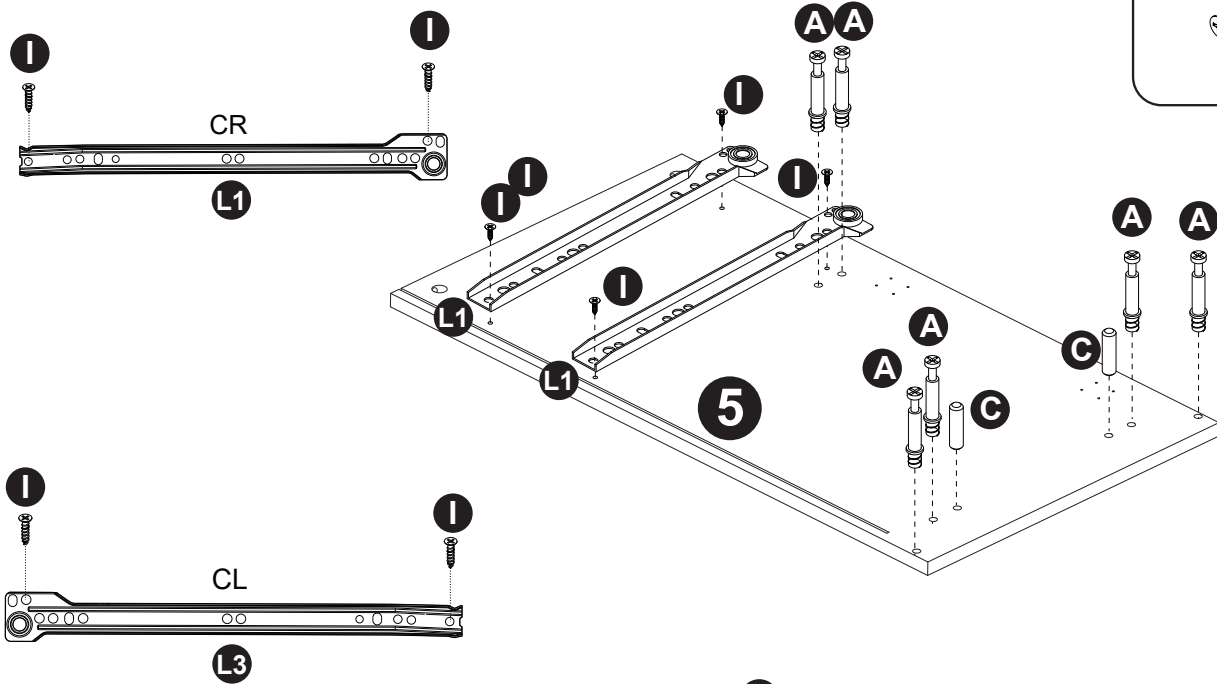
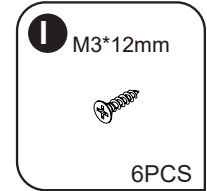
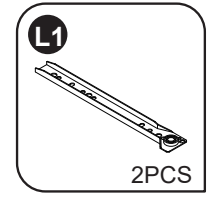
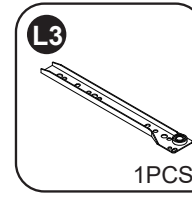
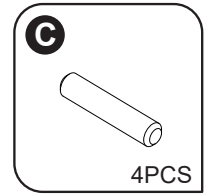
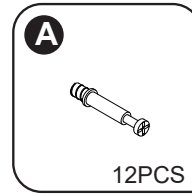
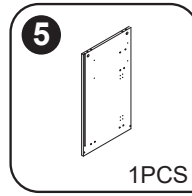
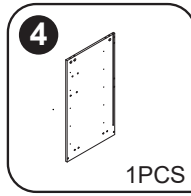

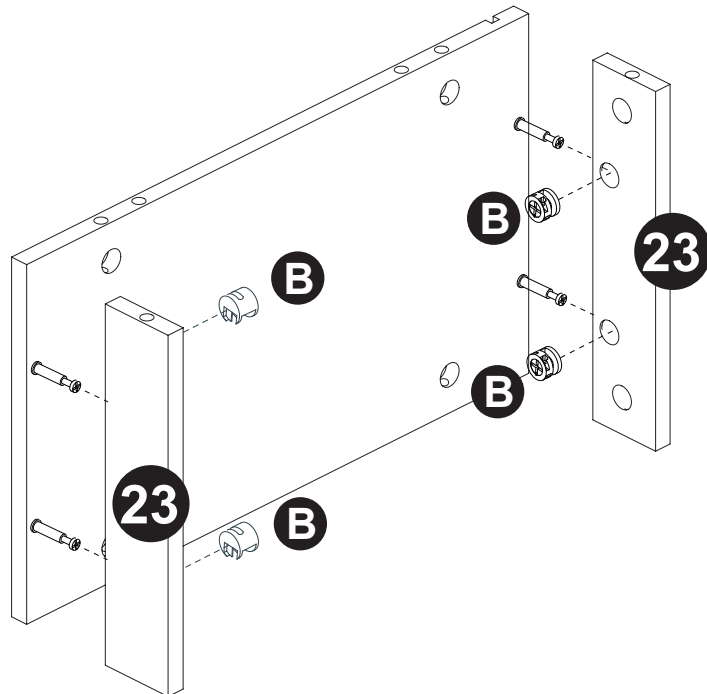
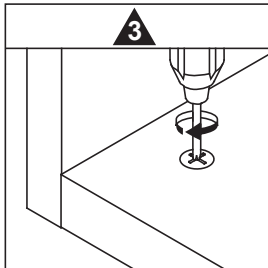
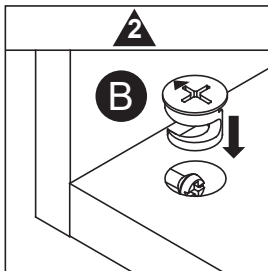
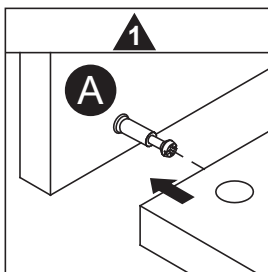
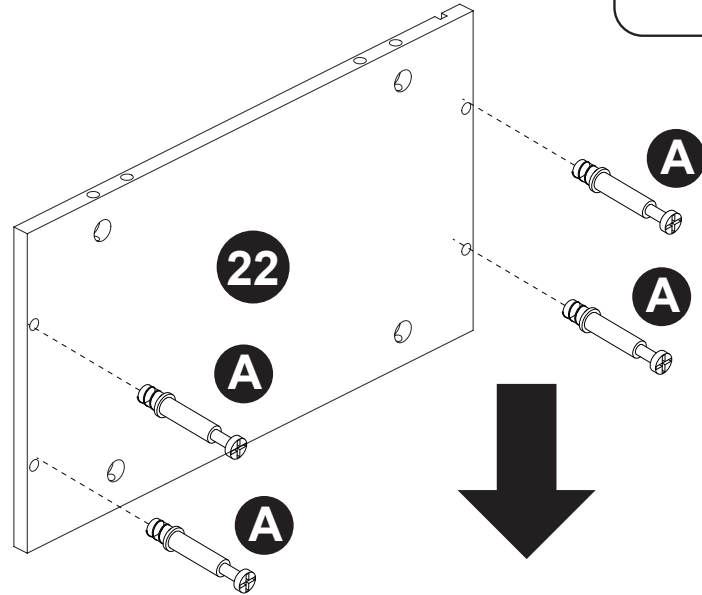
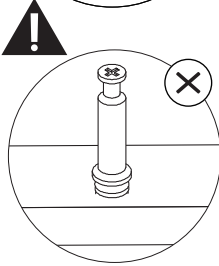
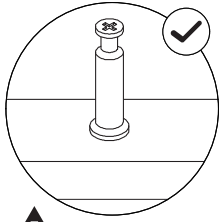
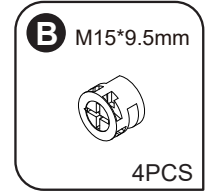
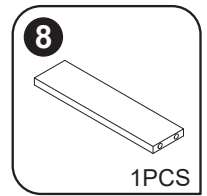
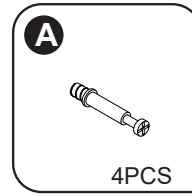
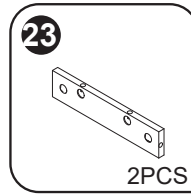
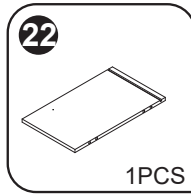

Step:4

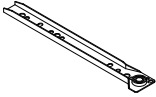

Step:5

I M3*12mm

 2PCS

L1

 1PCS

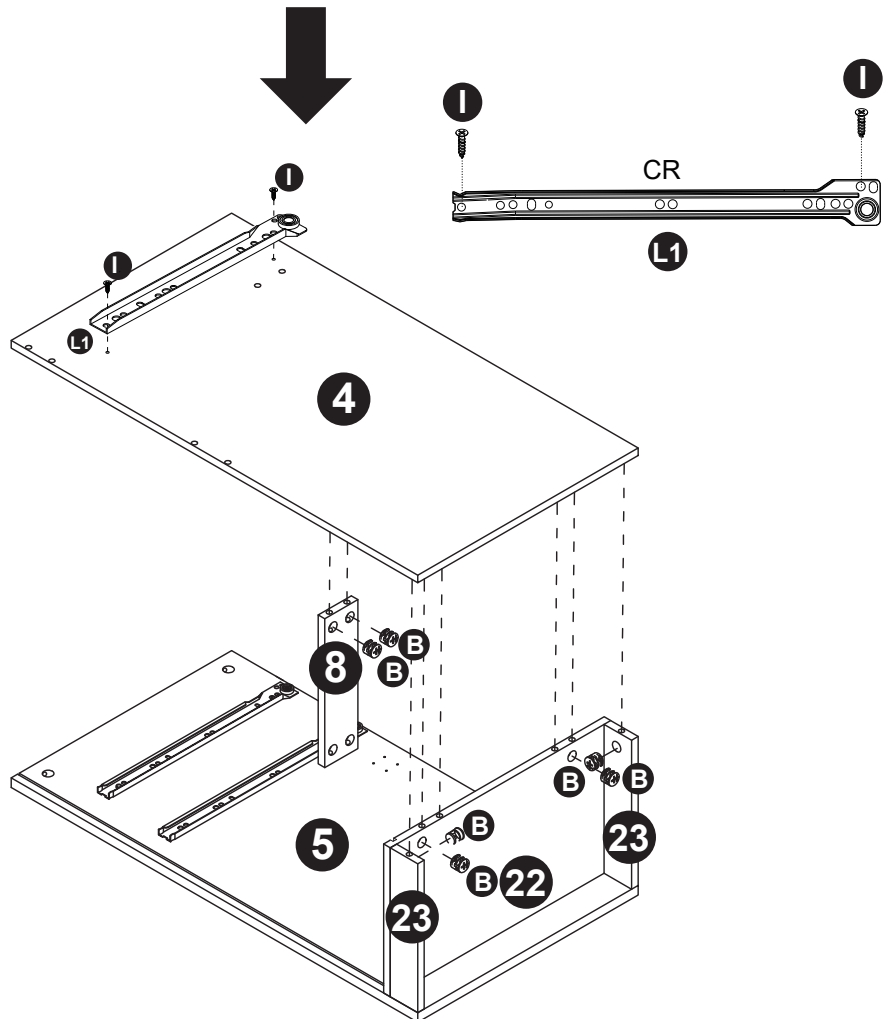
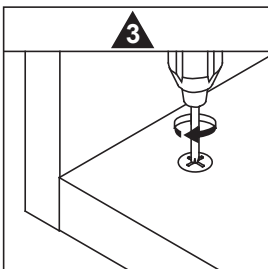
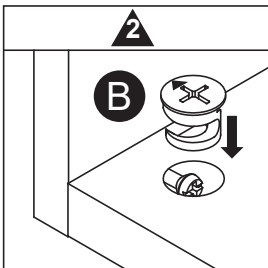
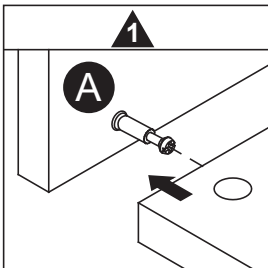
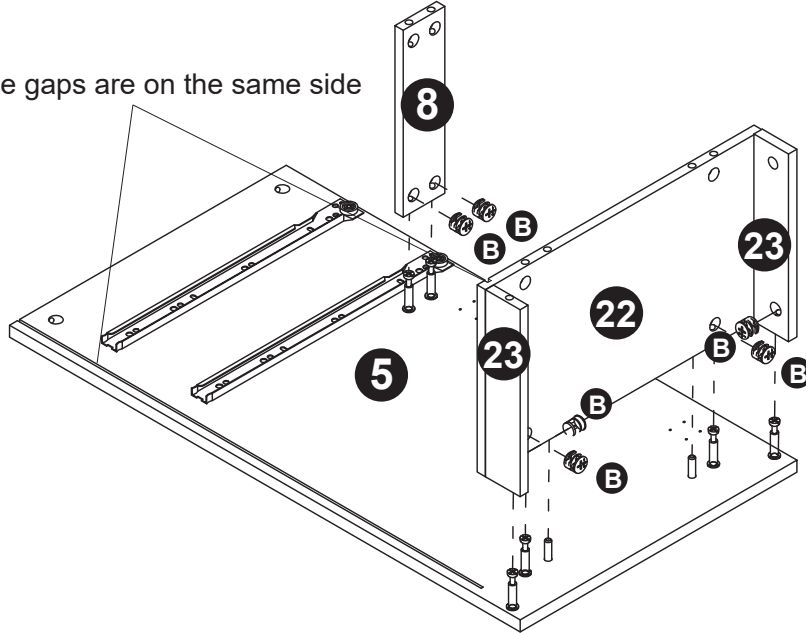
B M15*9.5mm

 12PCS

Note: that the gaps are on the same side

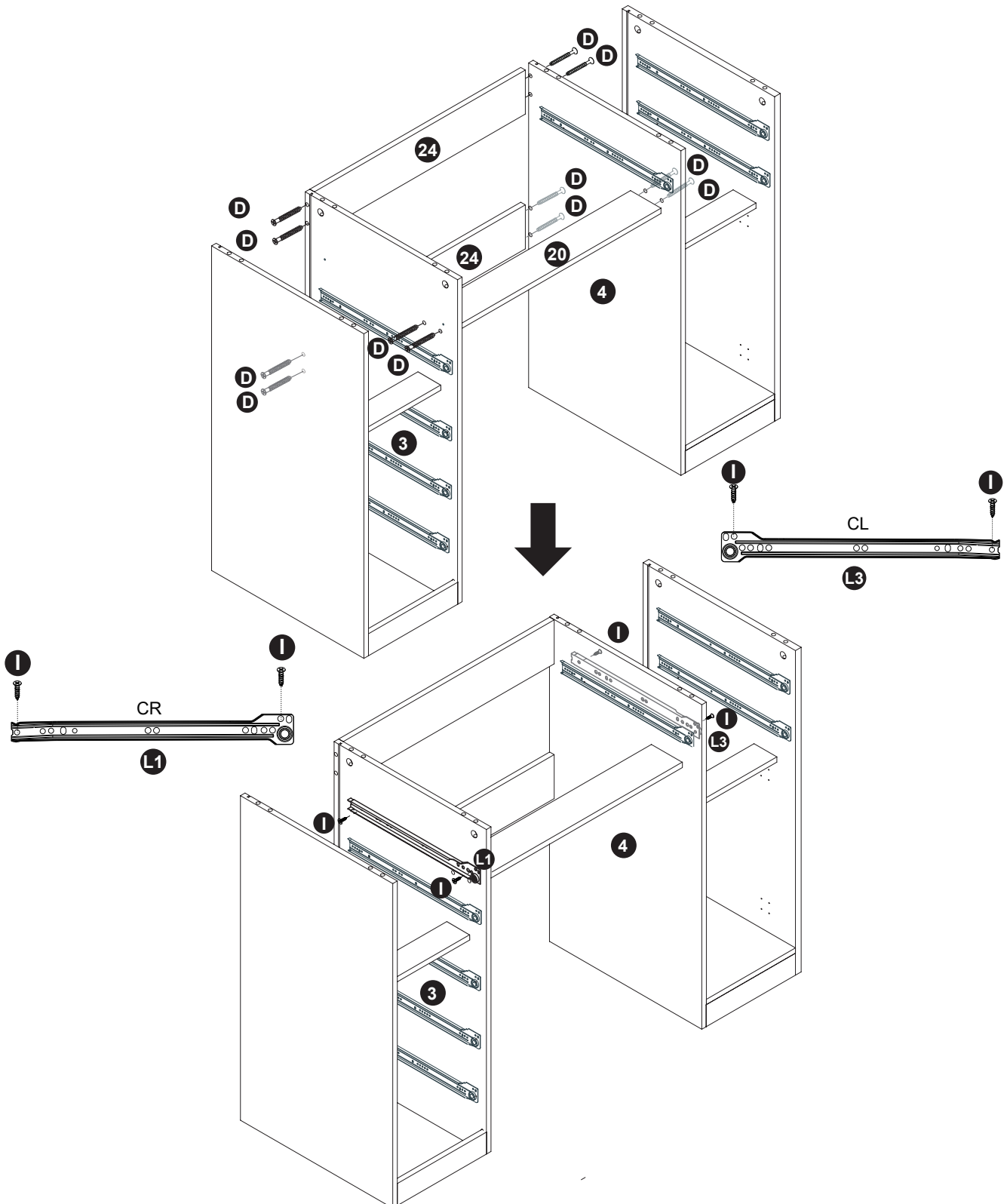
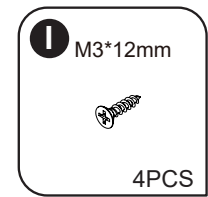
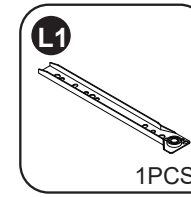
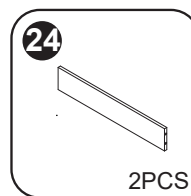
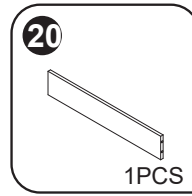

Step:6

It is recommended that assembly is undertaken by at least 2 adults. Be careful to support the wooden board.



Step:7

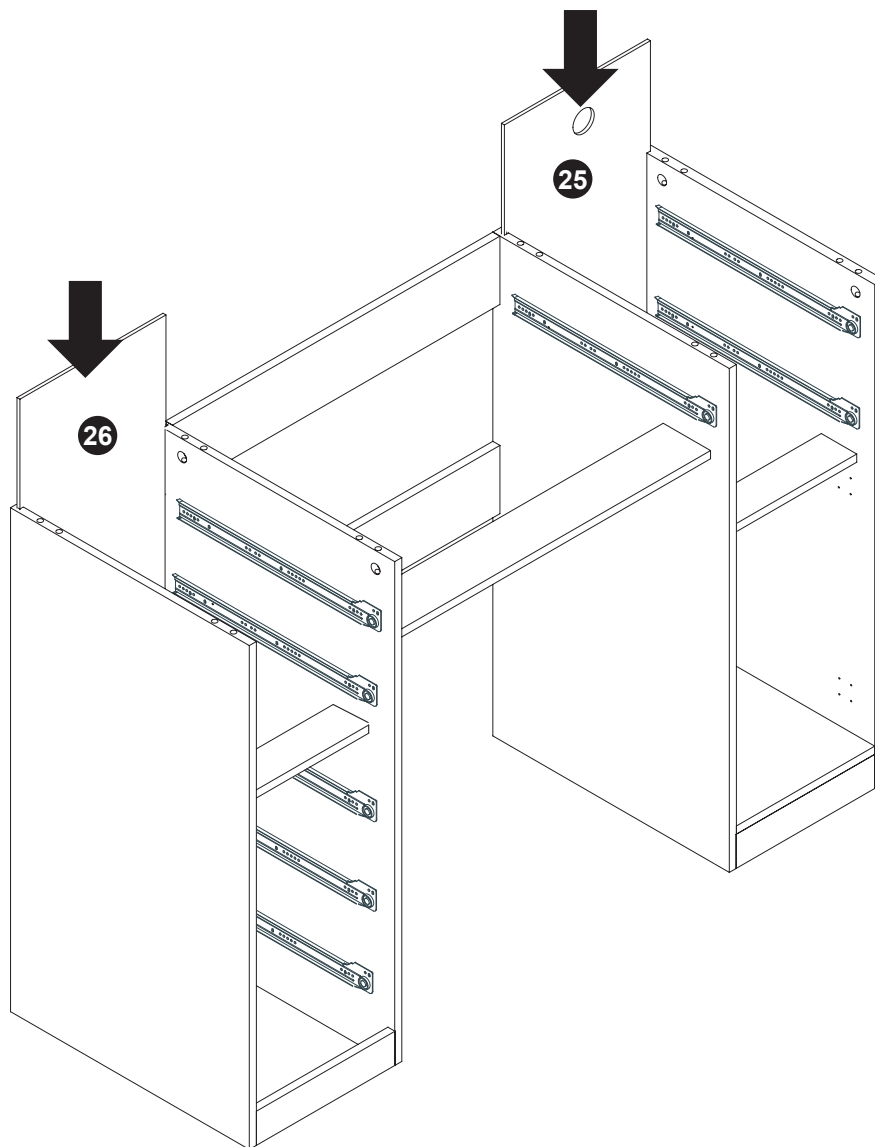
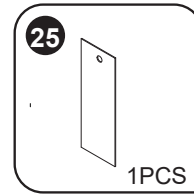

Step:9

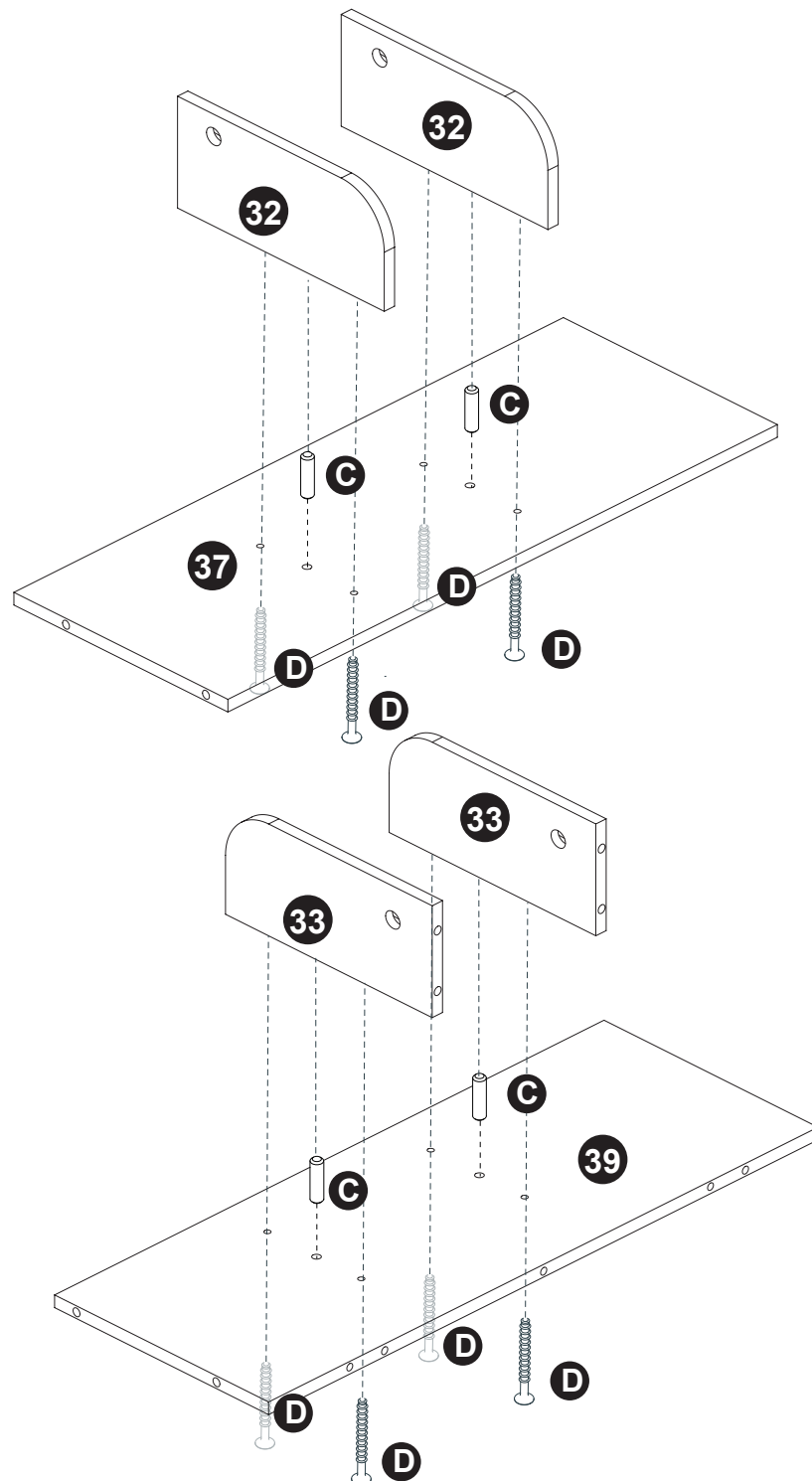
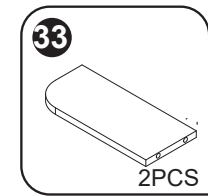
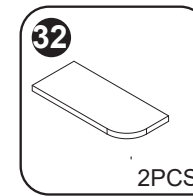
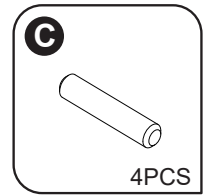
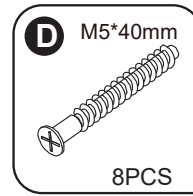
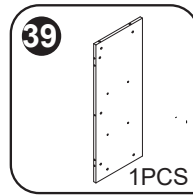
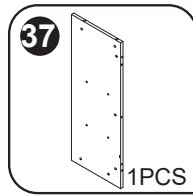

Step:10

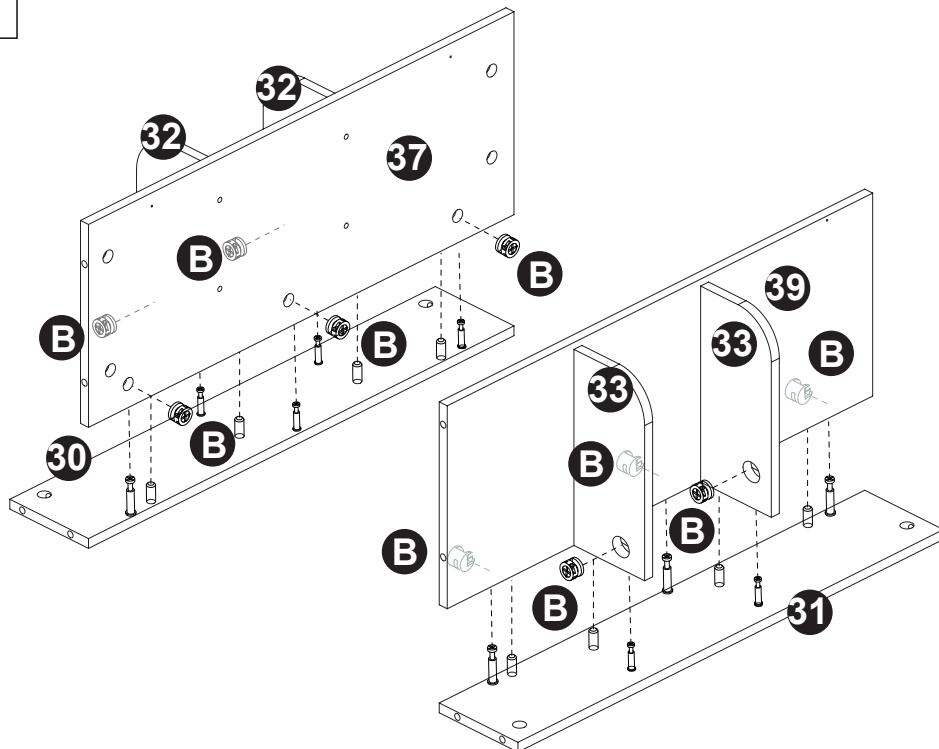
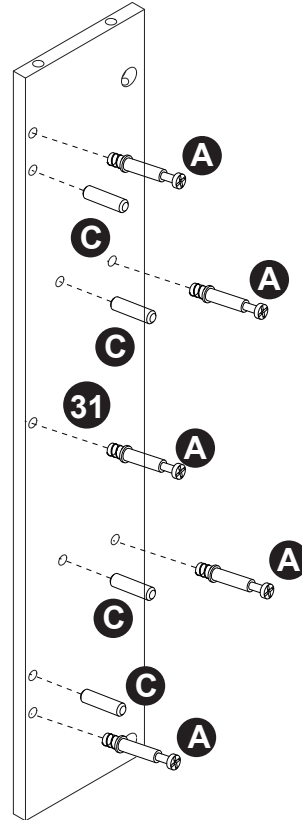
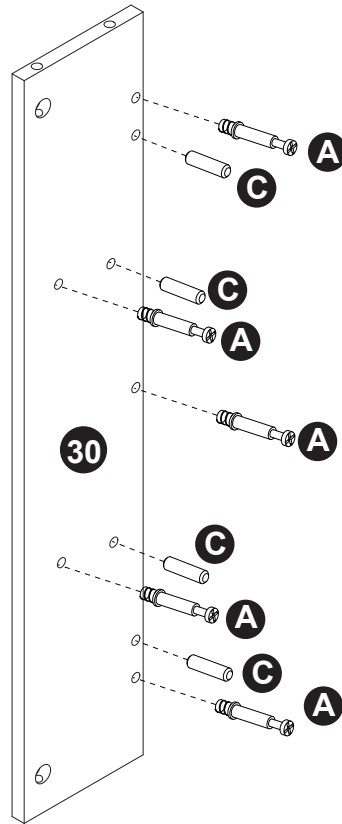
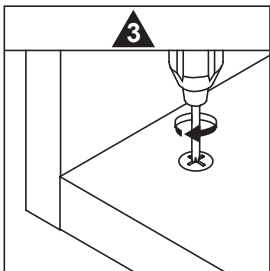
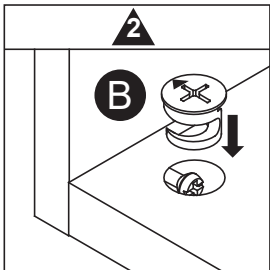
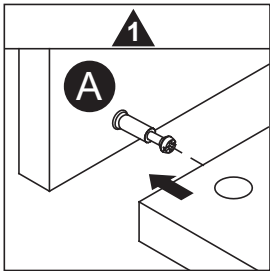
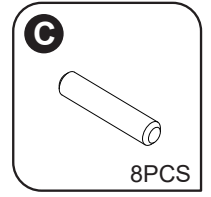
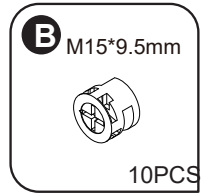
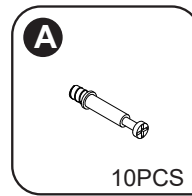
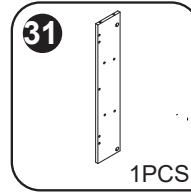
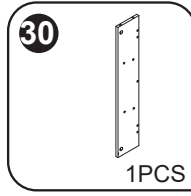

Step:11

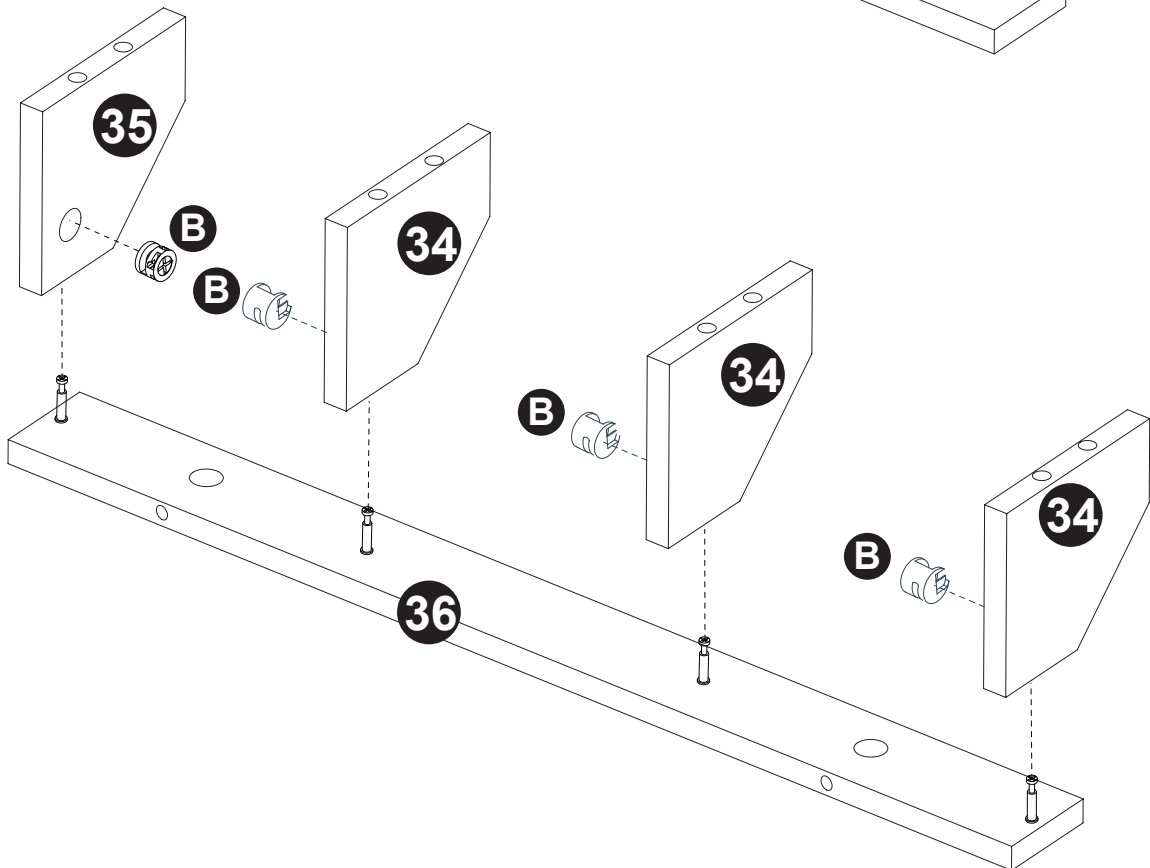
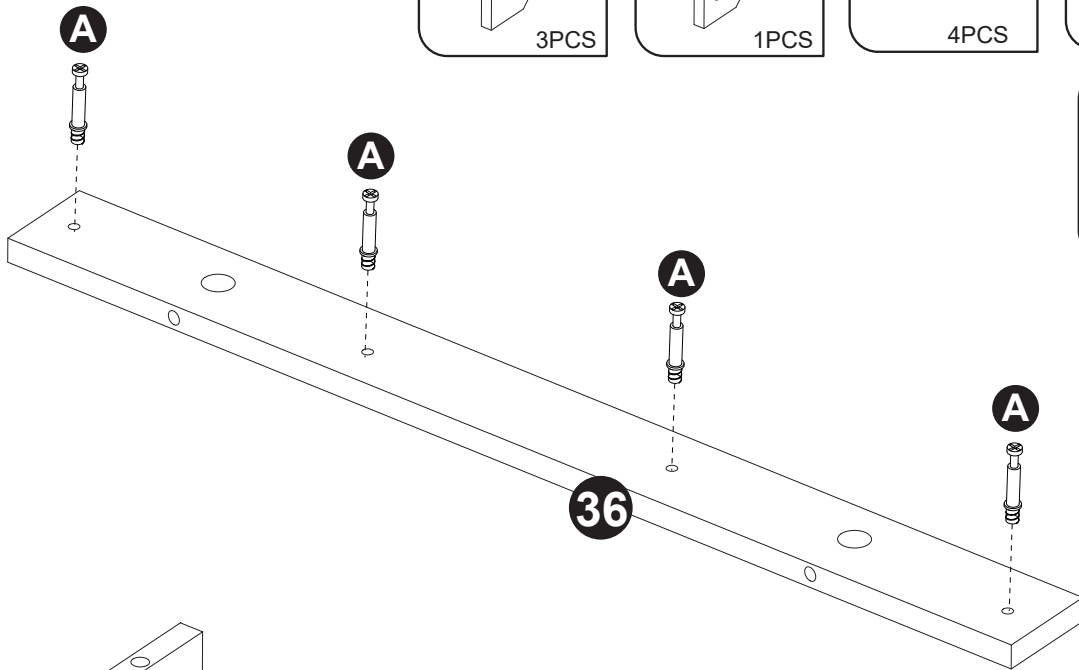
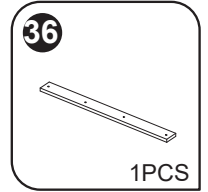
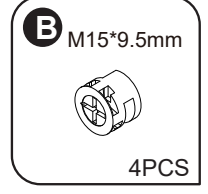
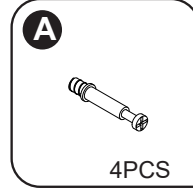
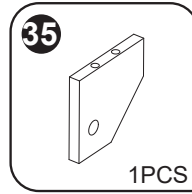

Step:12

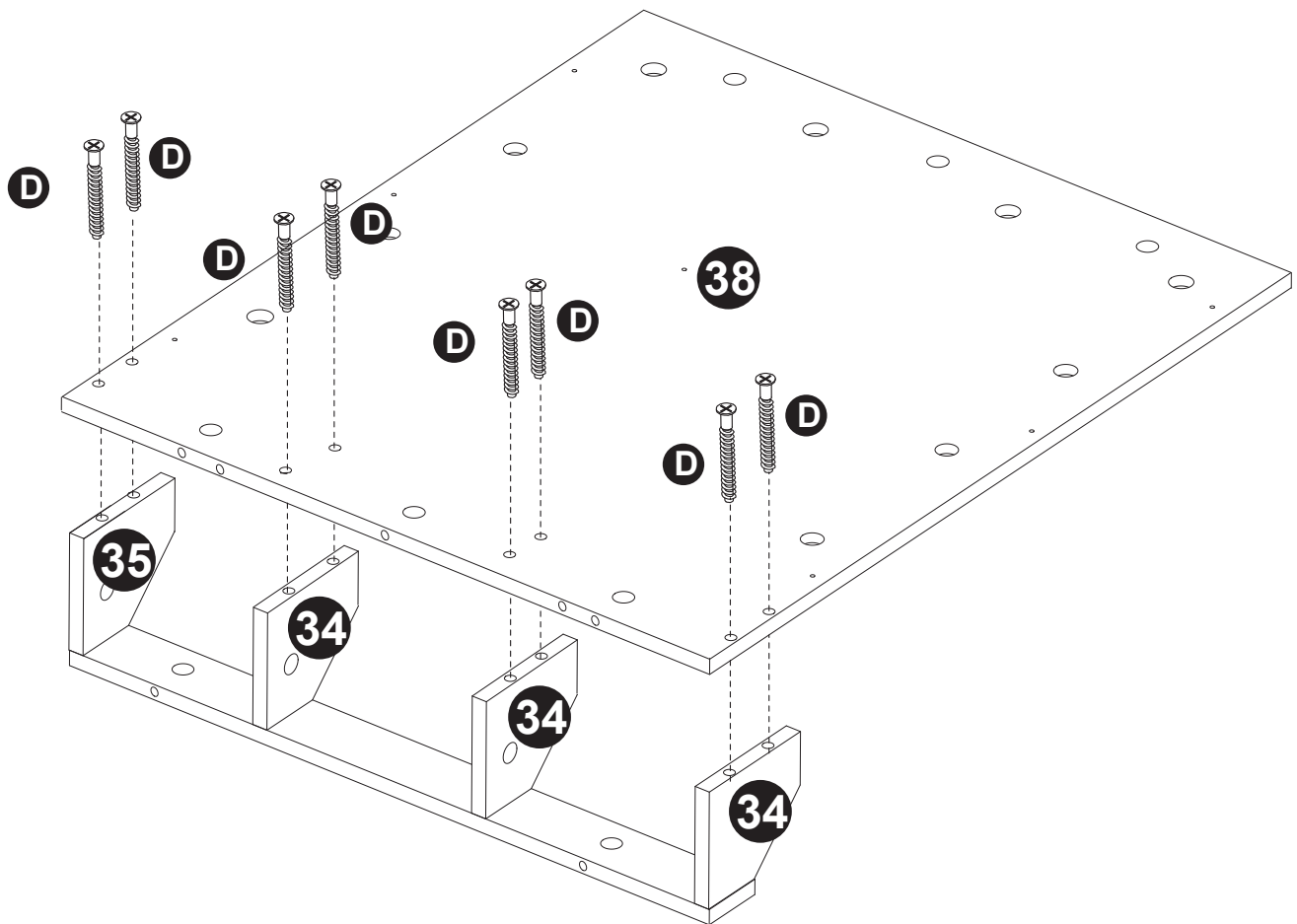
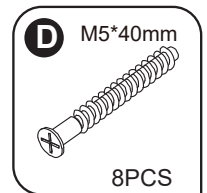
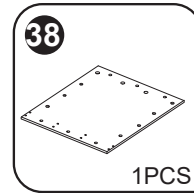

Step:13

It is recommended that assembly is undertaken by at least 2 adults. Be careful to support the wooden board.

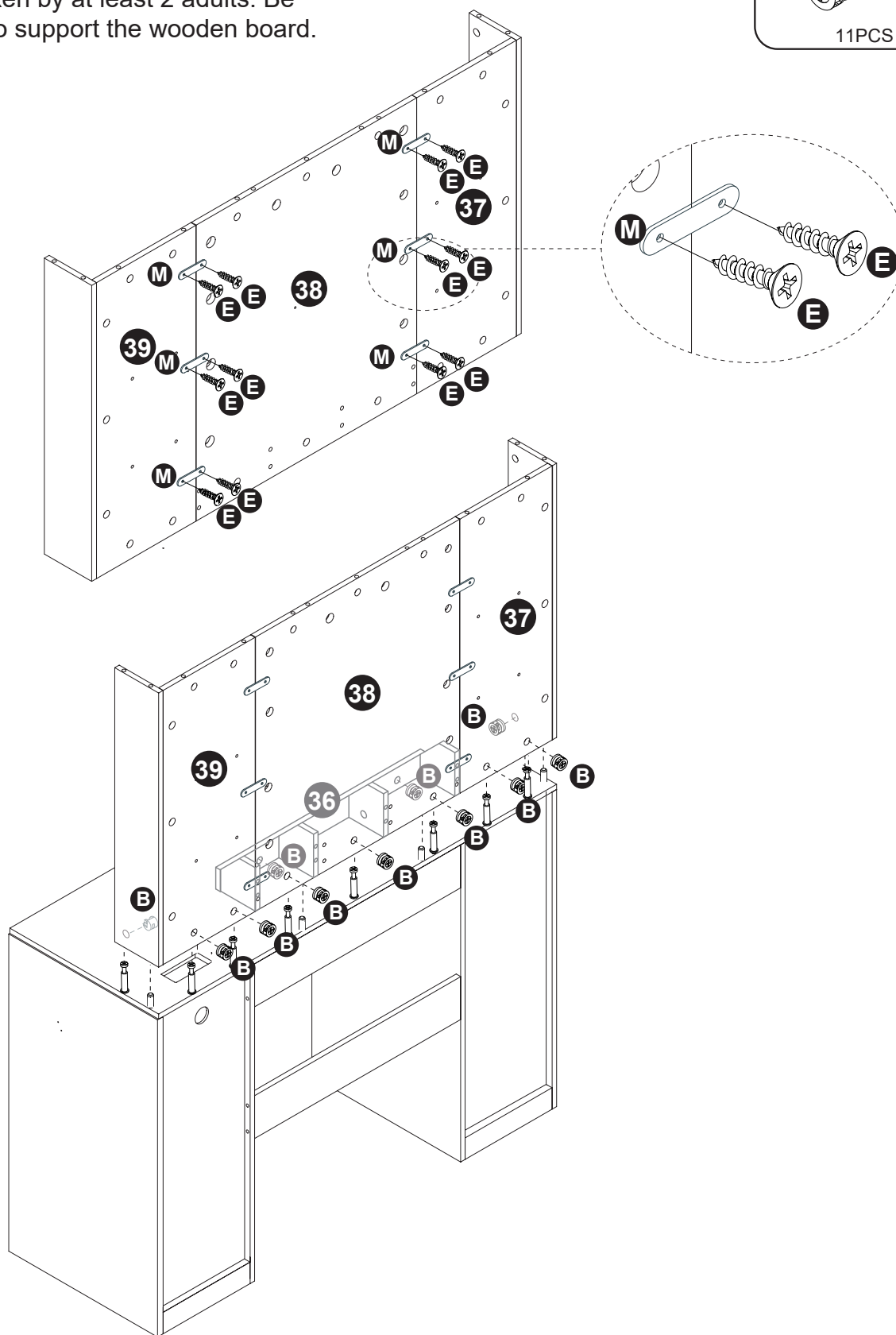
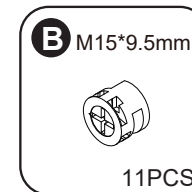
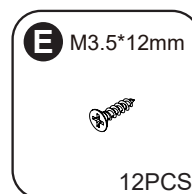
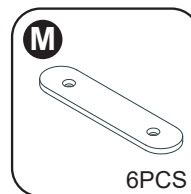

Step:14

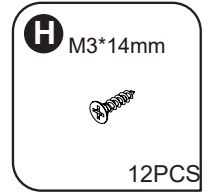
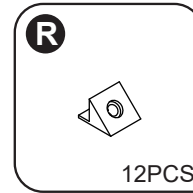
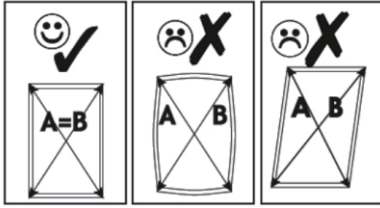

ATTENTION PLEASE

Please make sure the left and right doors are the same level and the backboard is right Angle before installing hardware D, MUST install hardware D to strengthen product stability

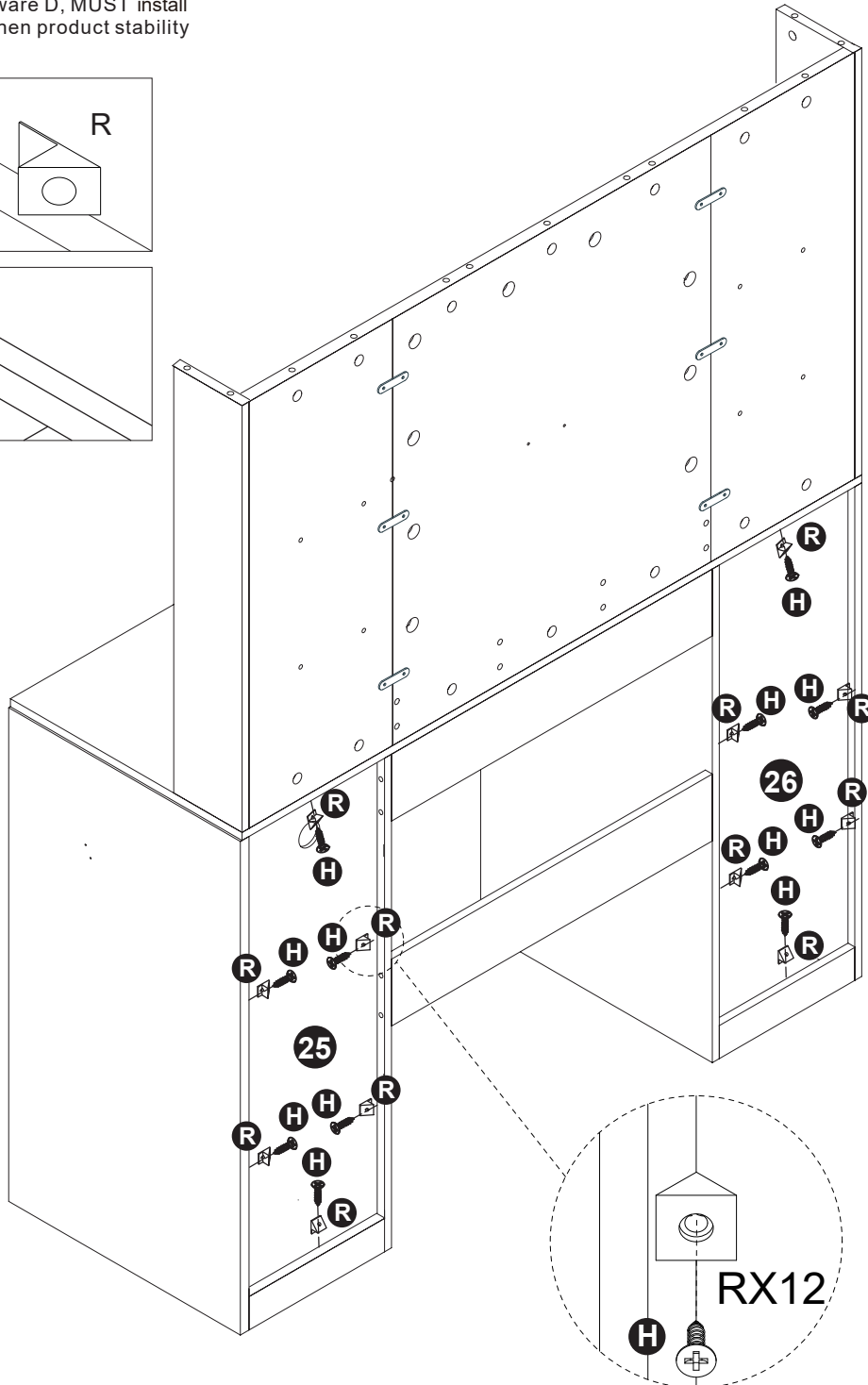
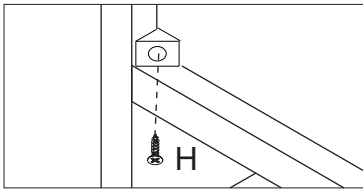
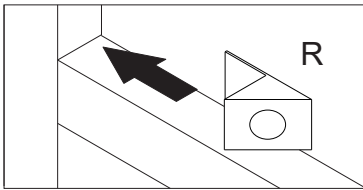

Step:15

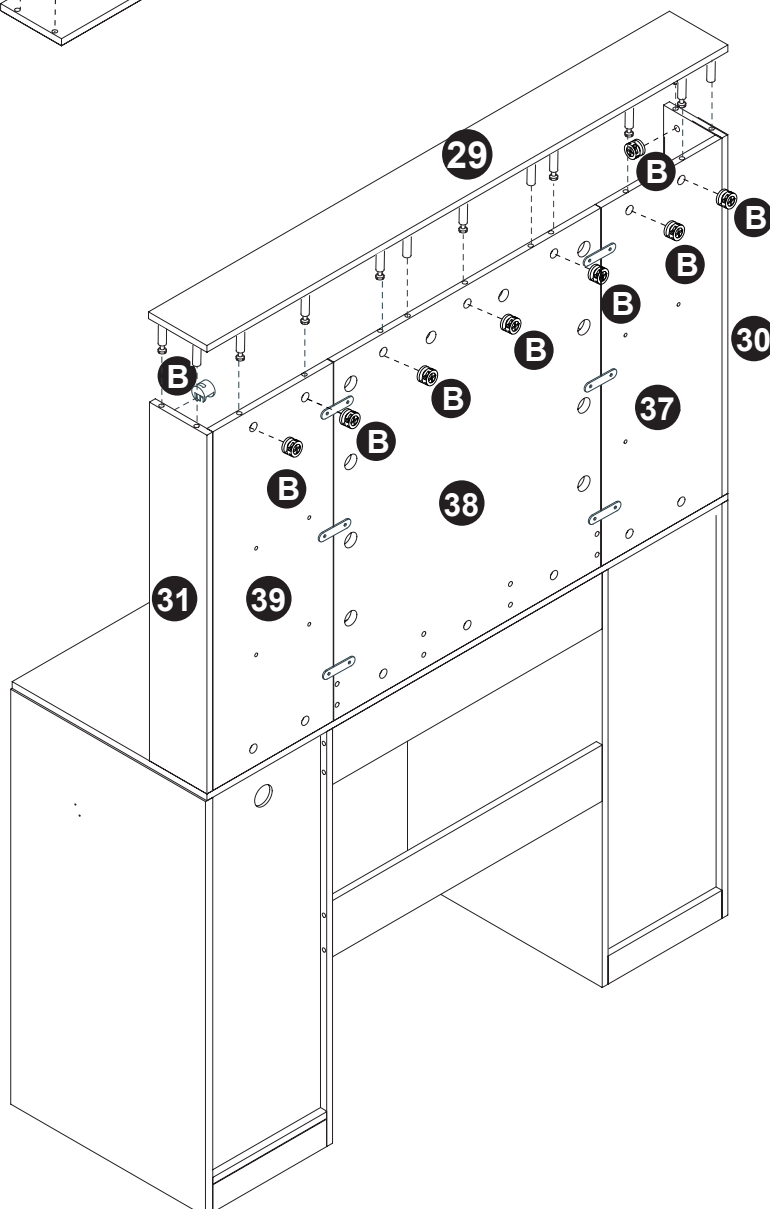
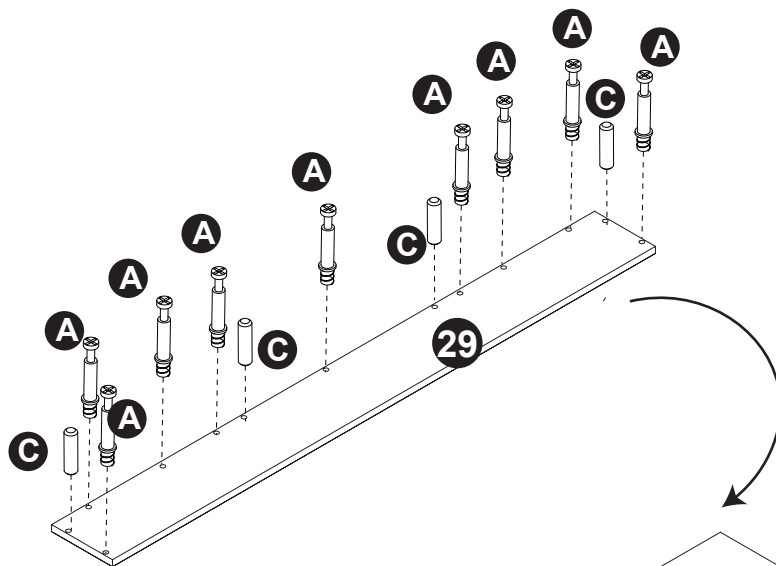
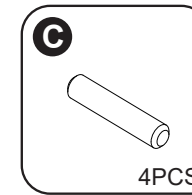
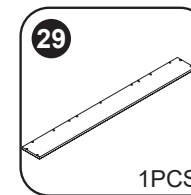
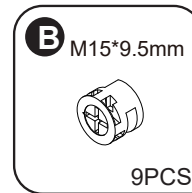
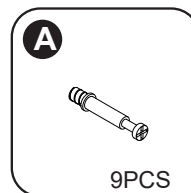

180°

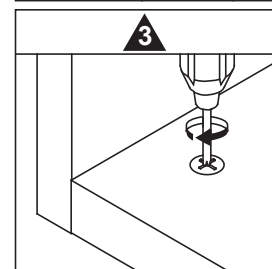
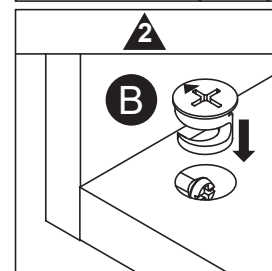
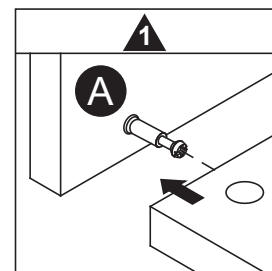

Step:16

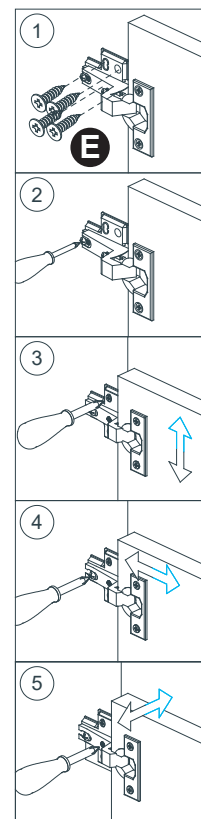
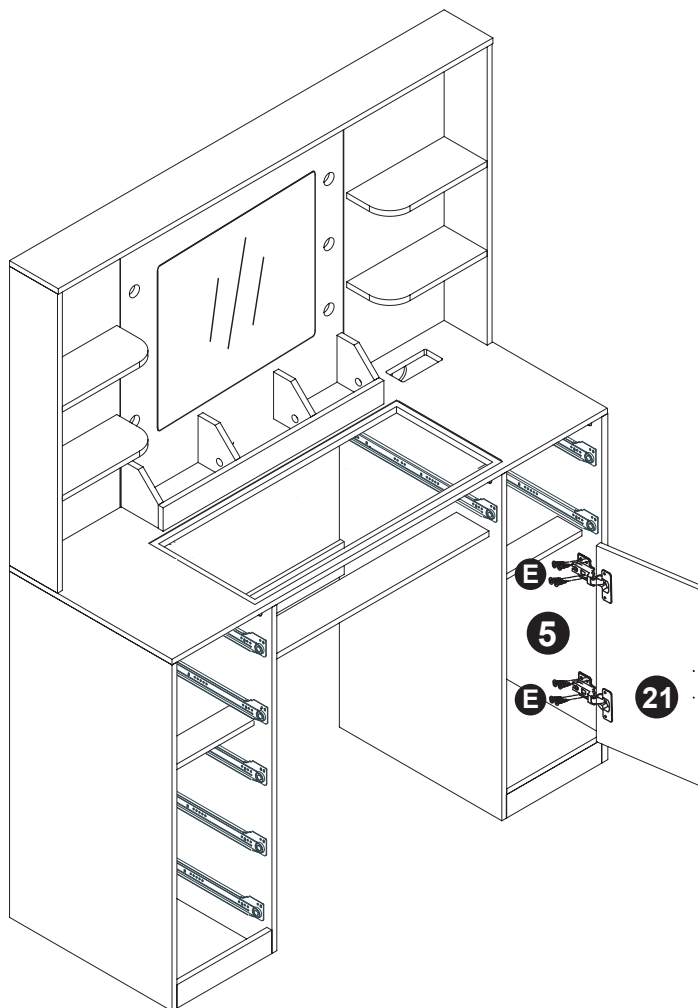
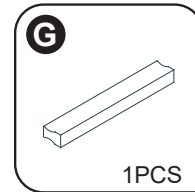
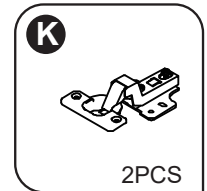
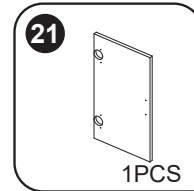
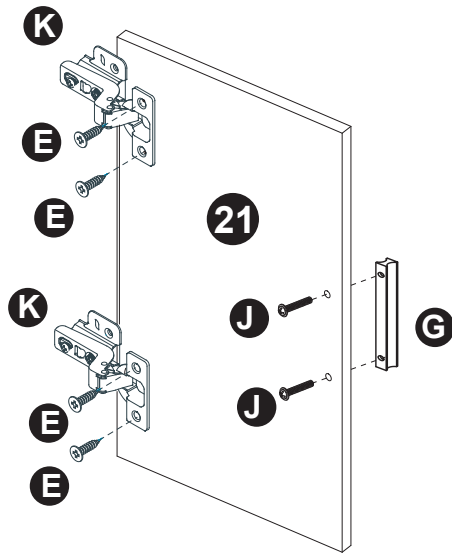

Step:17

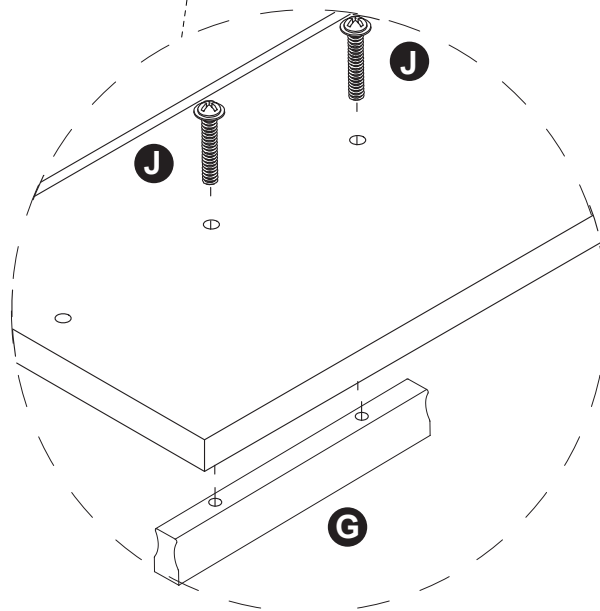
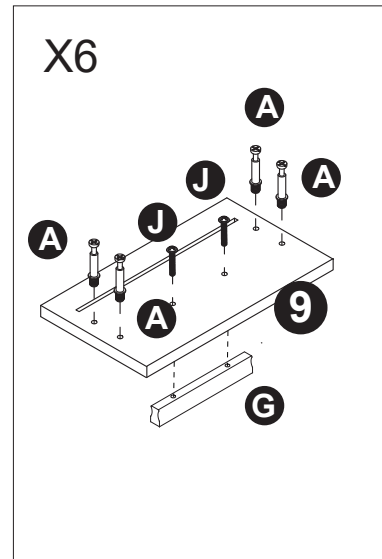
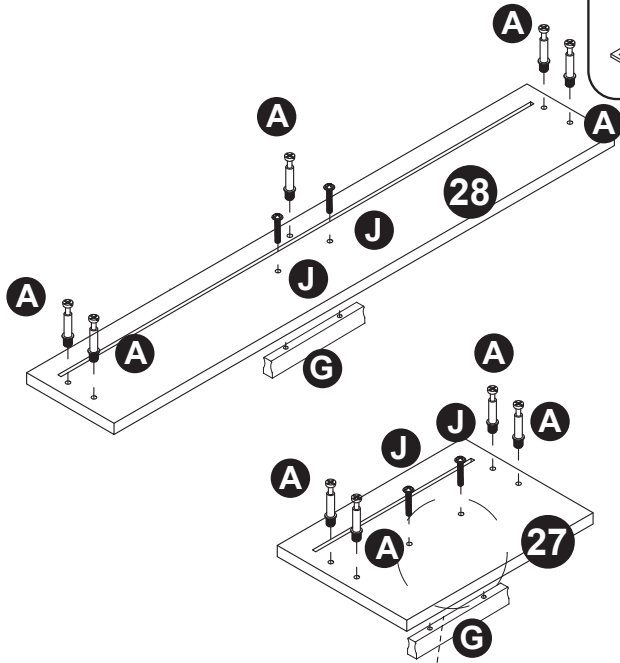
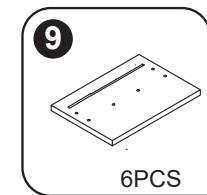
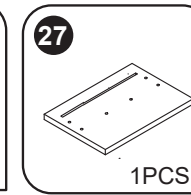
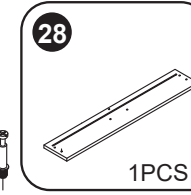
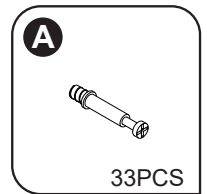
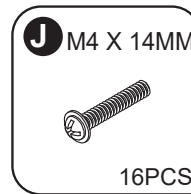
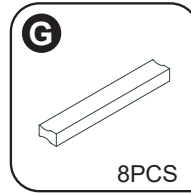

Step:18

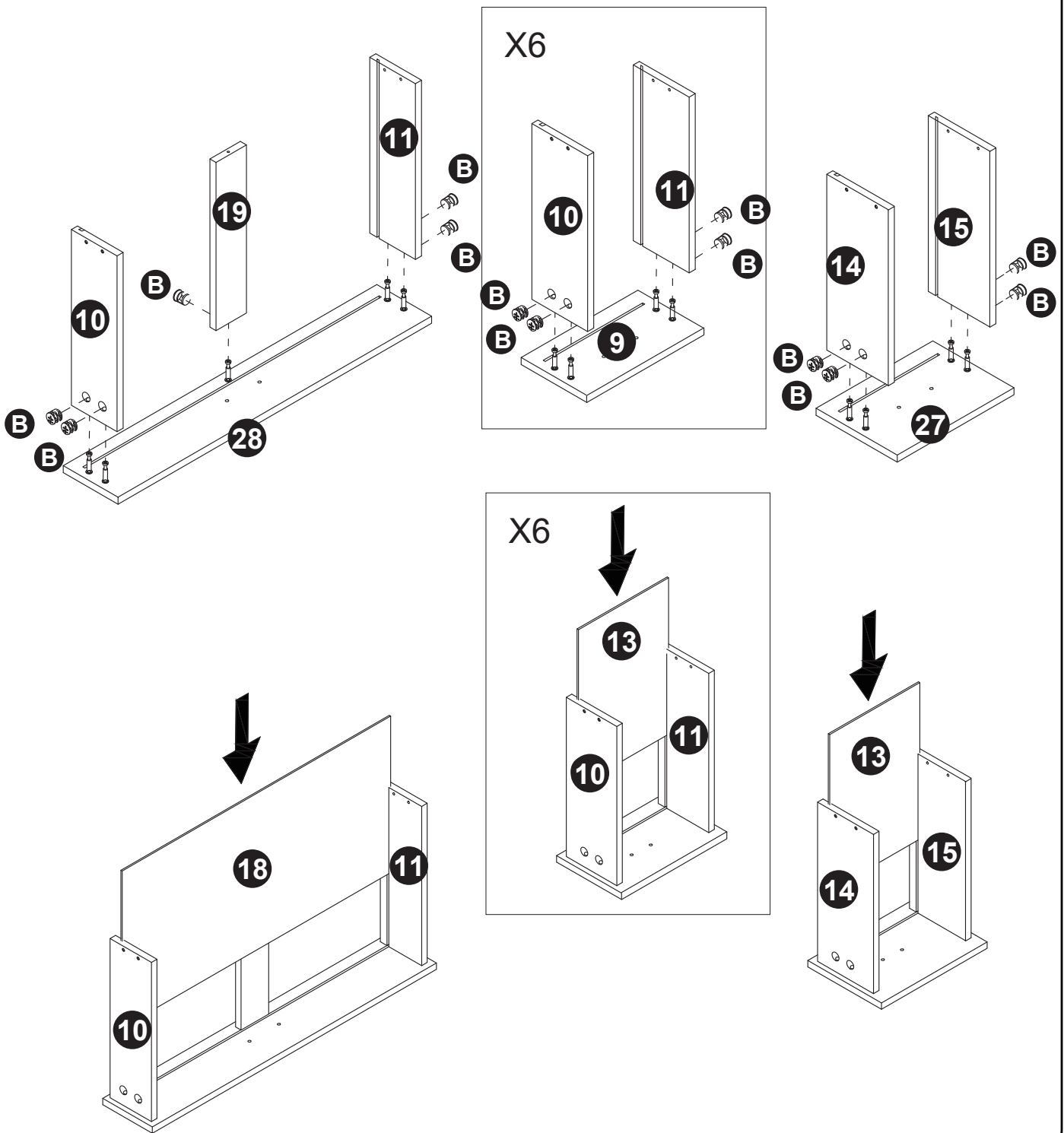
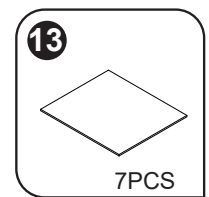
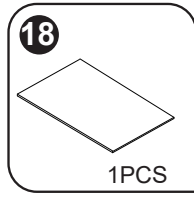
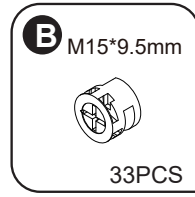
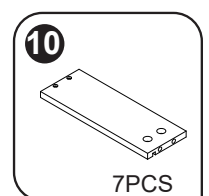
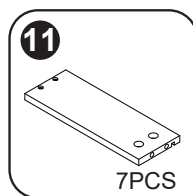
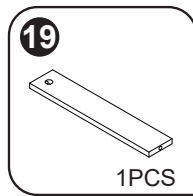
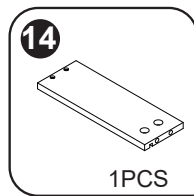
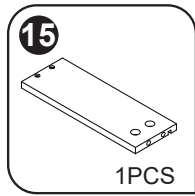

Step:19

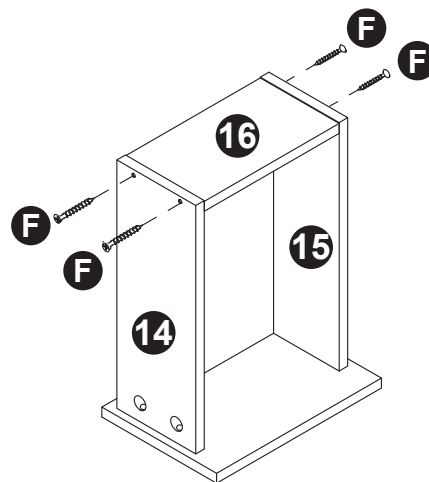
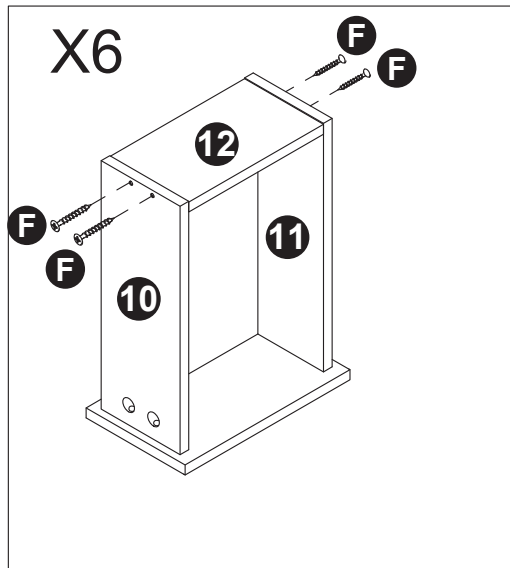
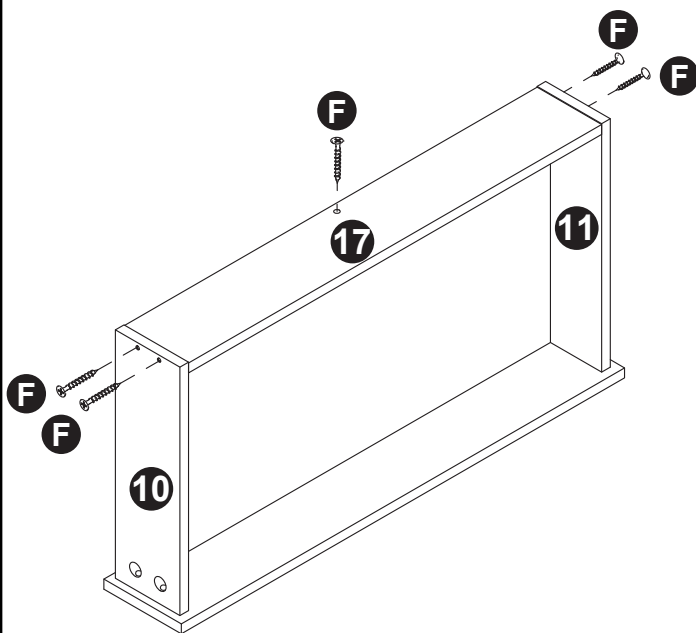
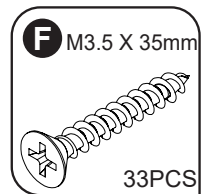
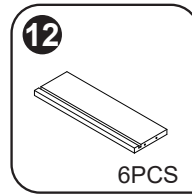
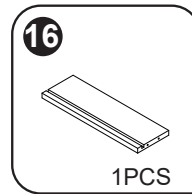
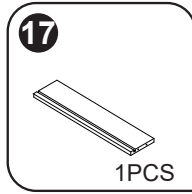

Step:20

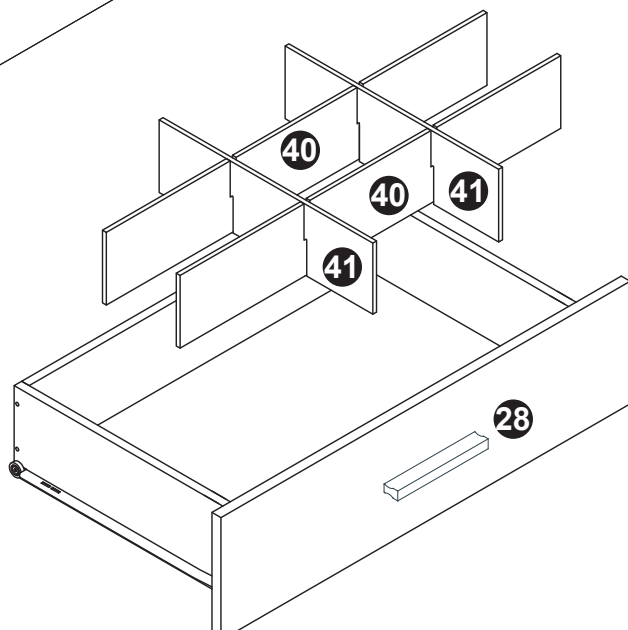
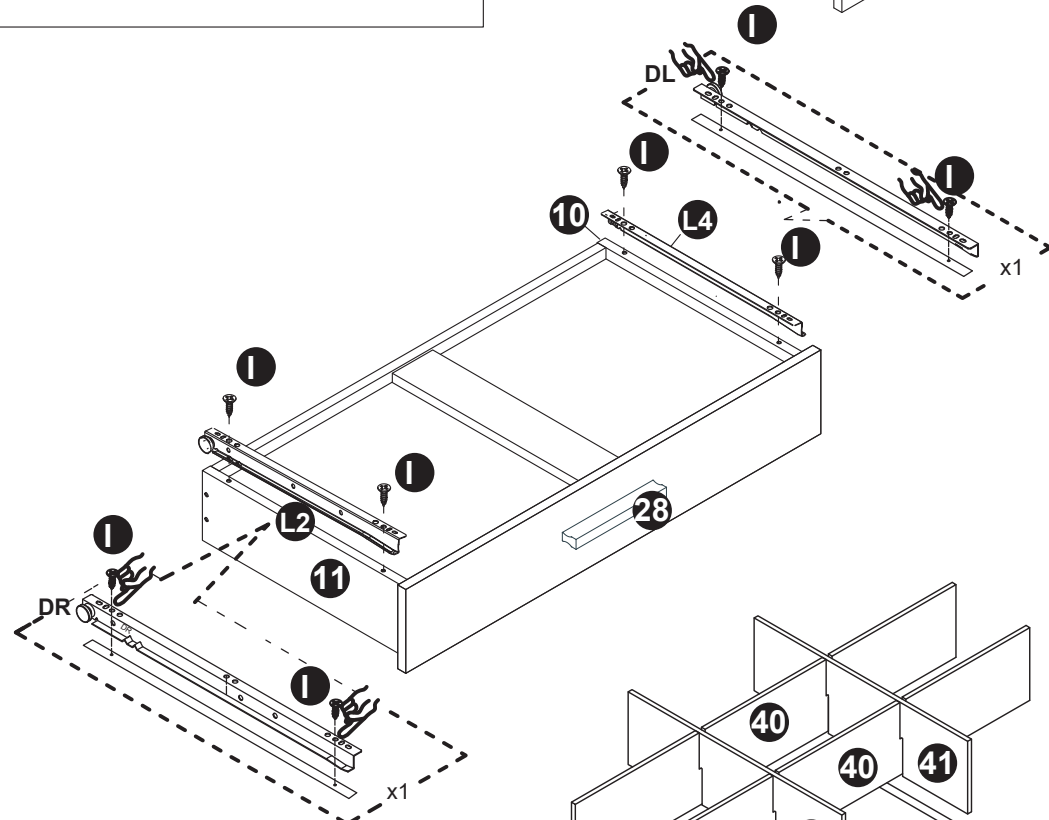
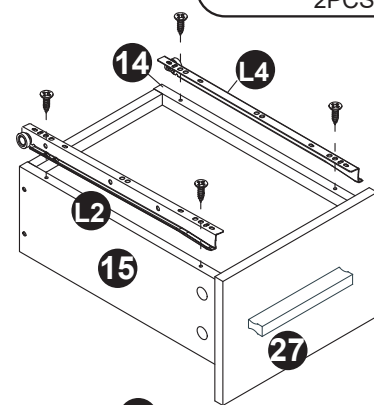
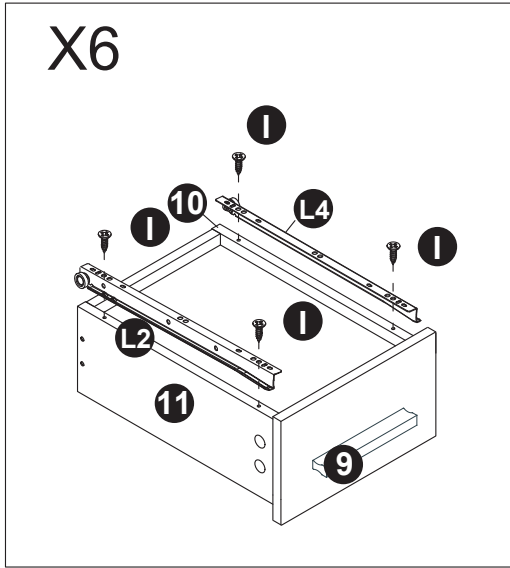
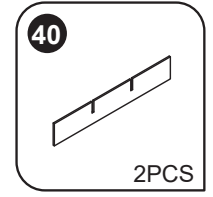
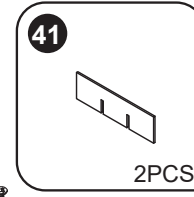
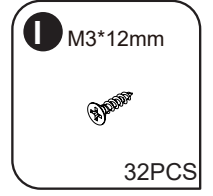
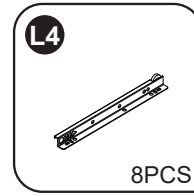
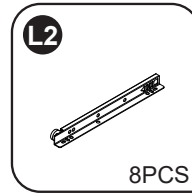

Step:21

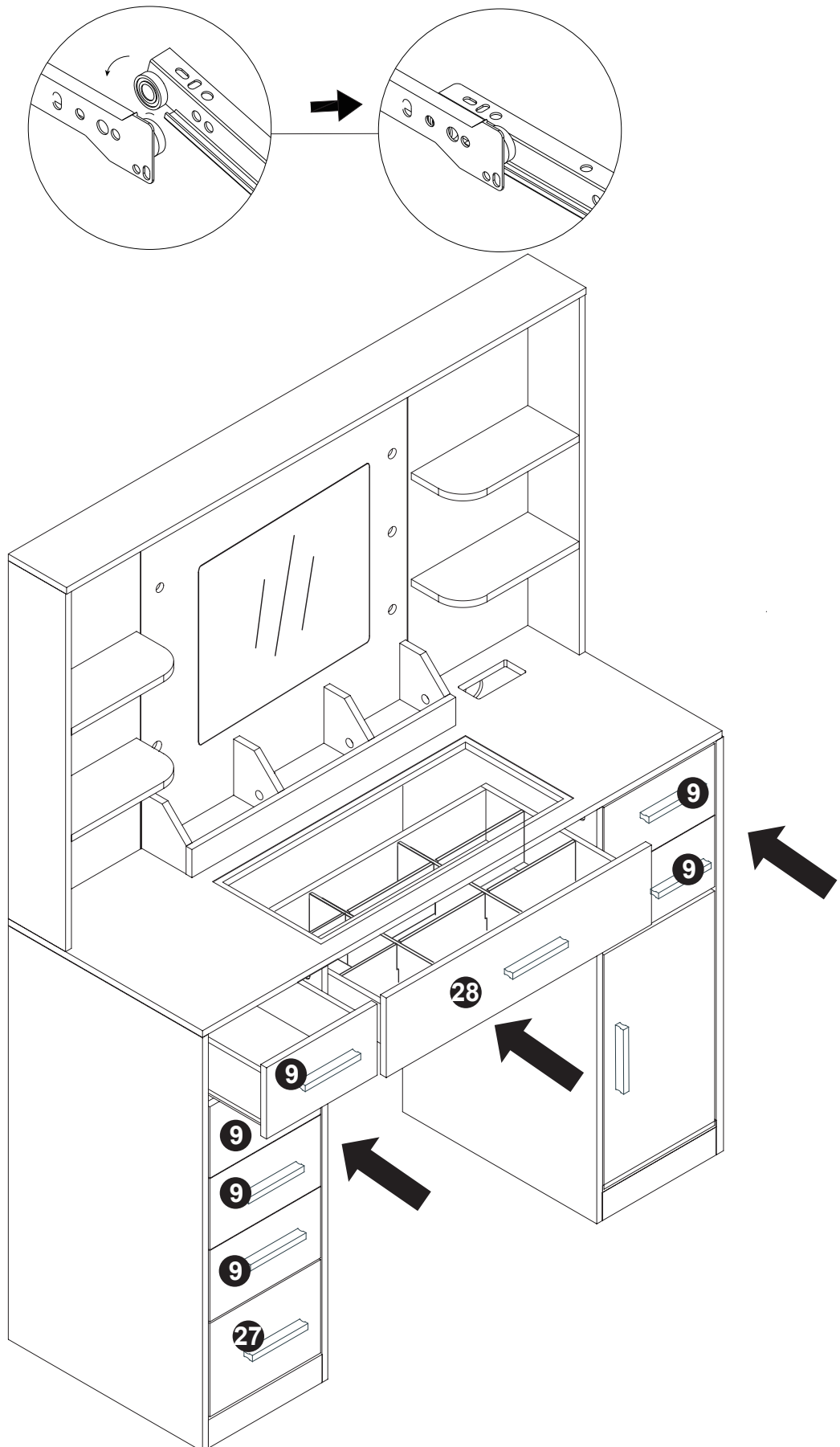

Step:22

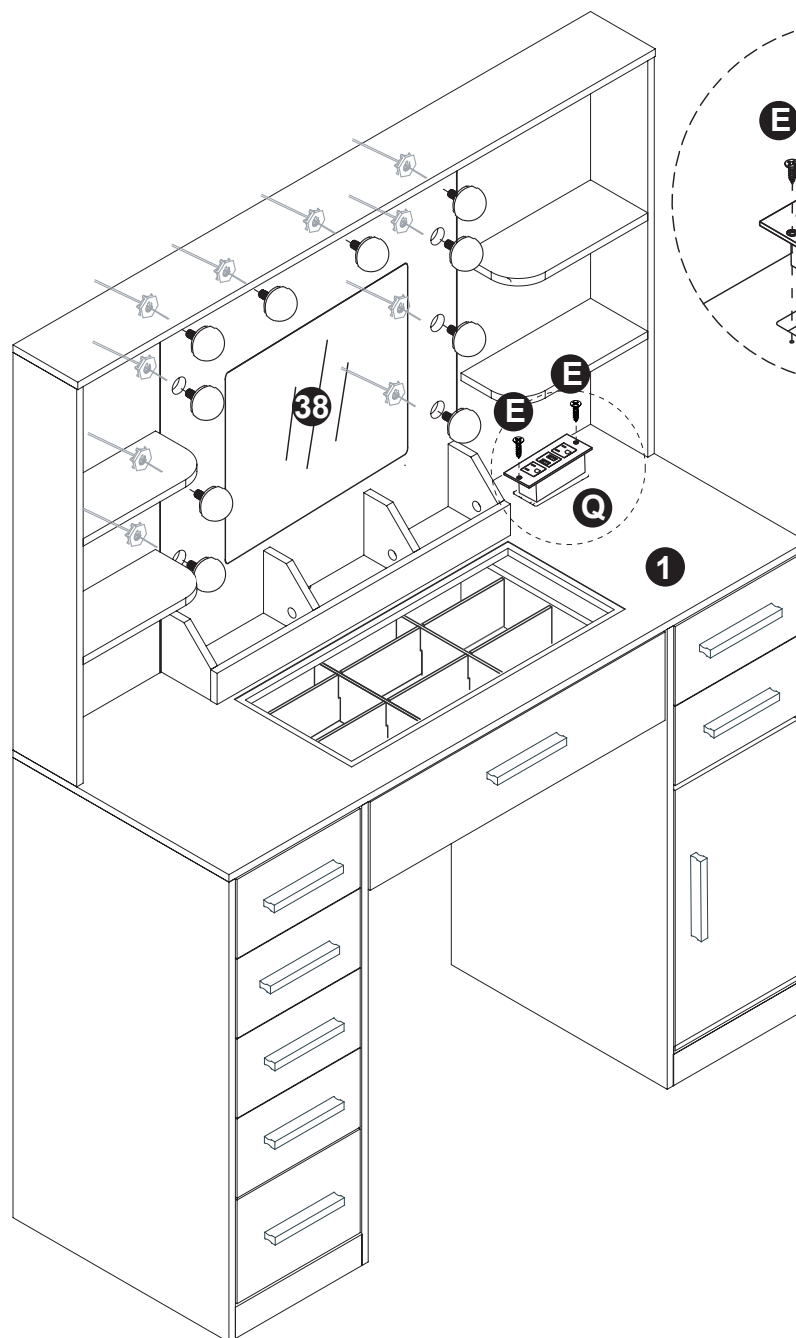
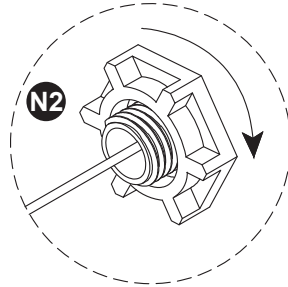
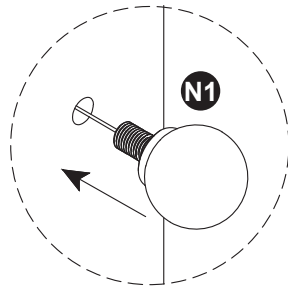
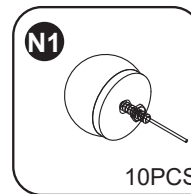
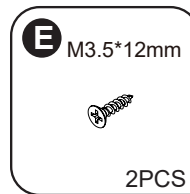
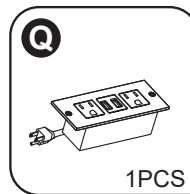

Step:23

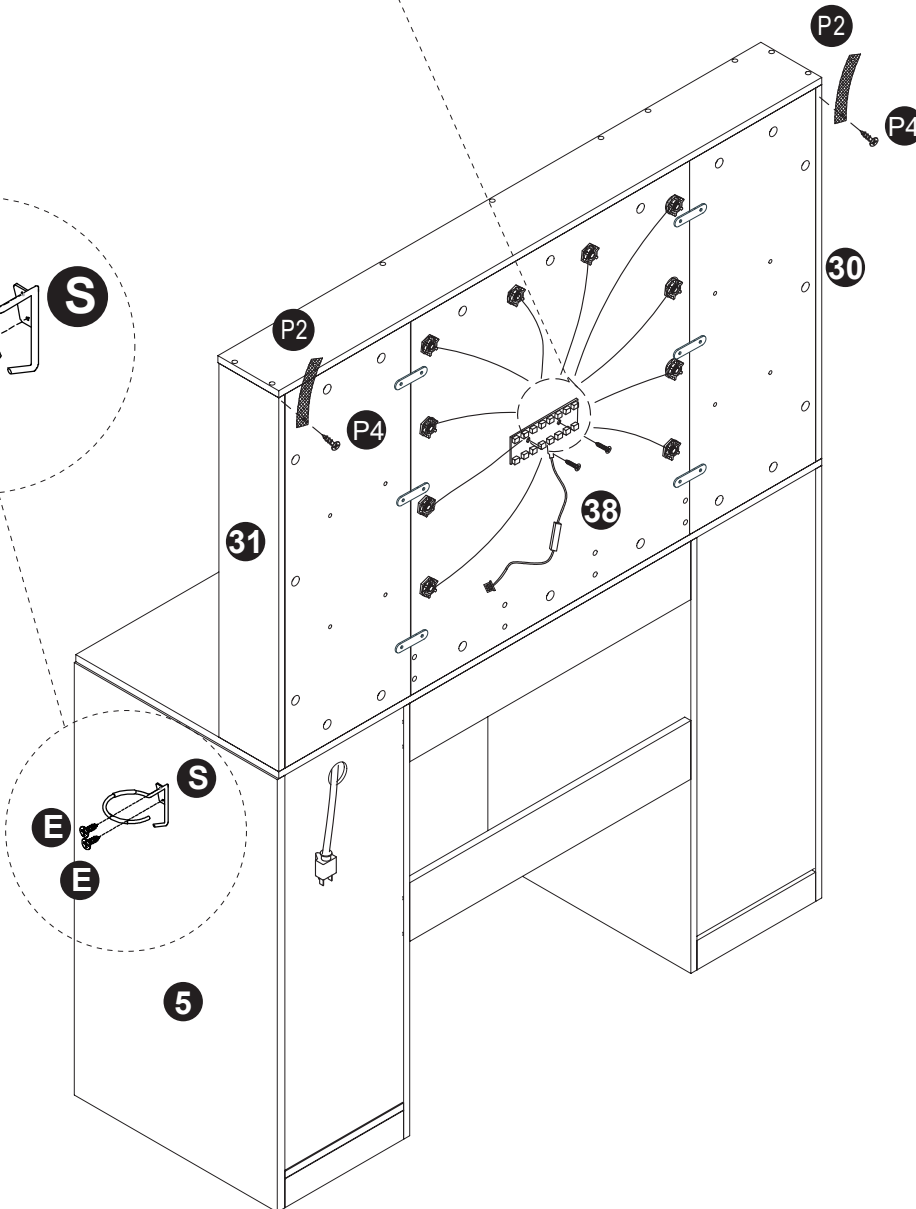
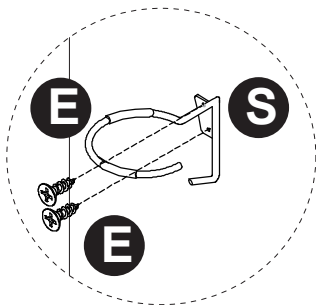
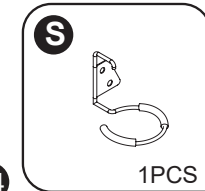
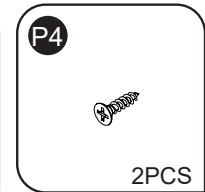
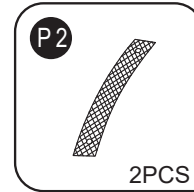
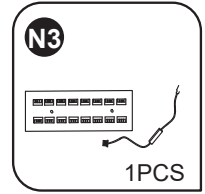
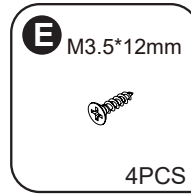
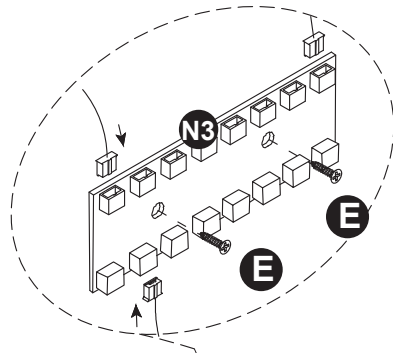

Step:24

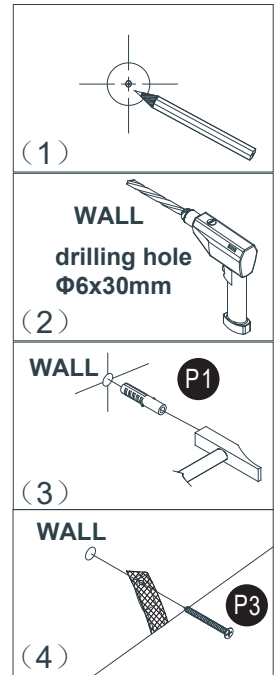
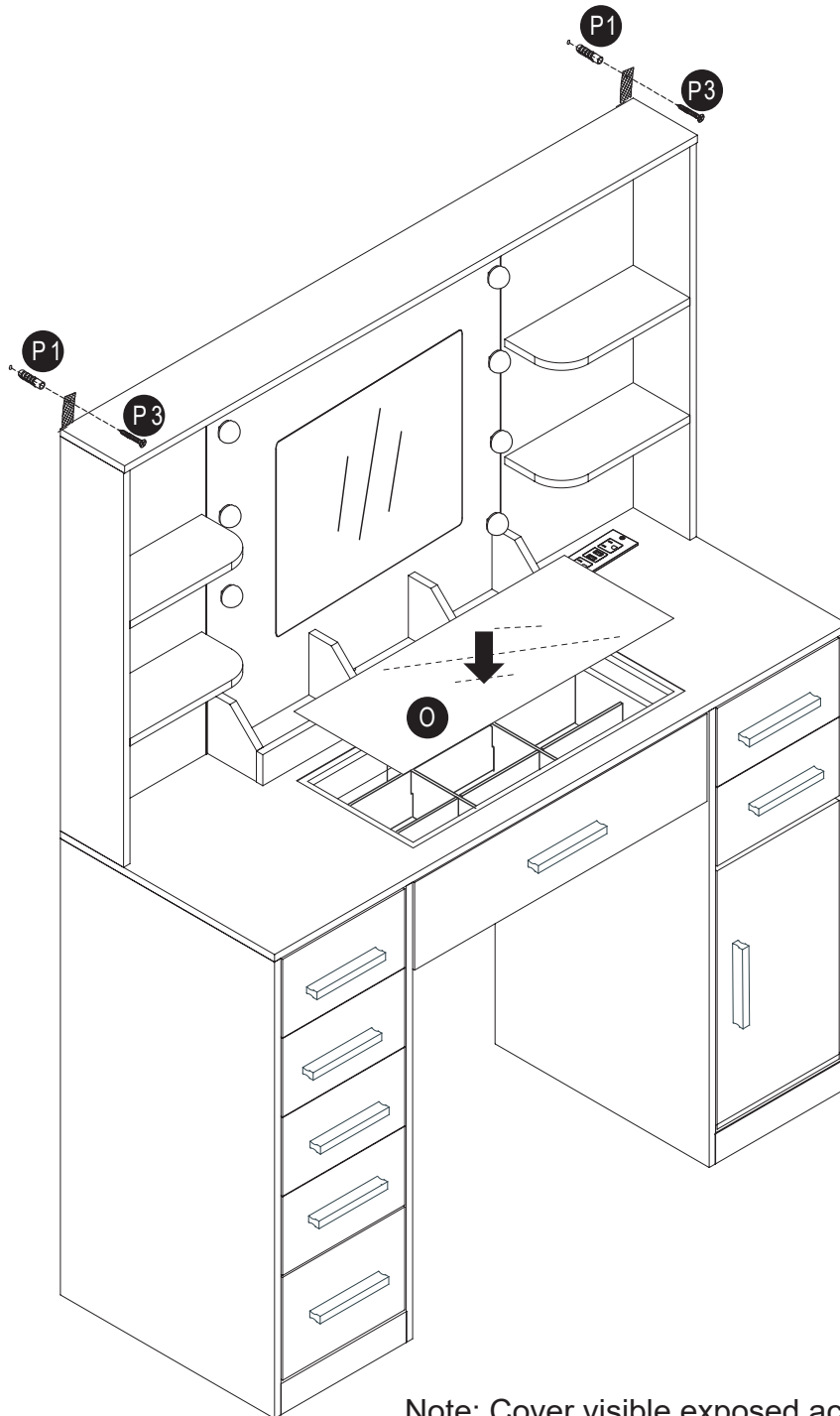
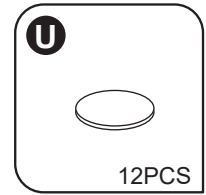
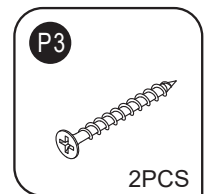
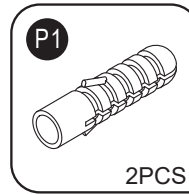
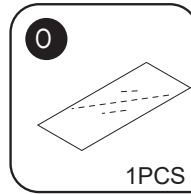

Note: Cover visible exposed accessory B with U sticker

