









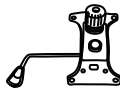

USER'S MANUAL/HANDBUCH/MANUEL DE L'UTILISATEUR

/MANUALE UTENTE/INSTRUKCJA OBSŁUGI

Gaming Chair/Gaming Stuhl/Chaise Gaming/

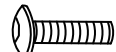
Sedia da Gioco/Krzeslo gamingowe

HW65897/HW66783

Ax1 	Bx1 	Cx1 (L) x1 (R) 	Dx1 	Ex1 	Fx1 
Gx4  M6x20 SCREW /SCHRAUBE /VIS /VITE /ŠRUBA	Hx8  M8x30 SCREW /SCHRAUBE /VIS /VITE /ŠRUBA	Ix8 	Jx4 	K M6x1 	Lx1 

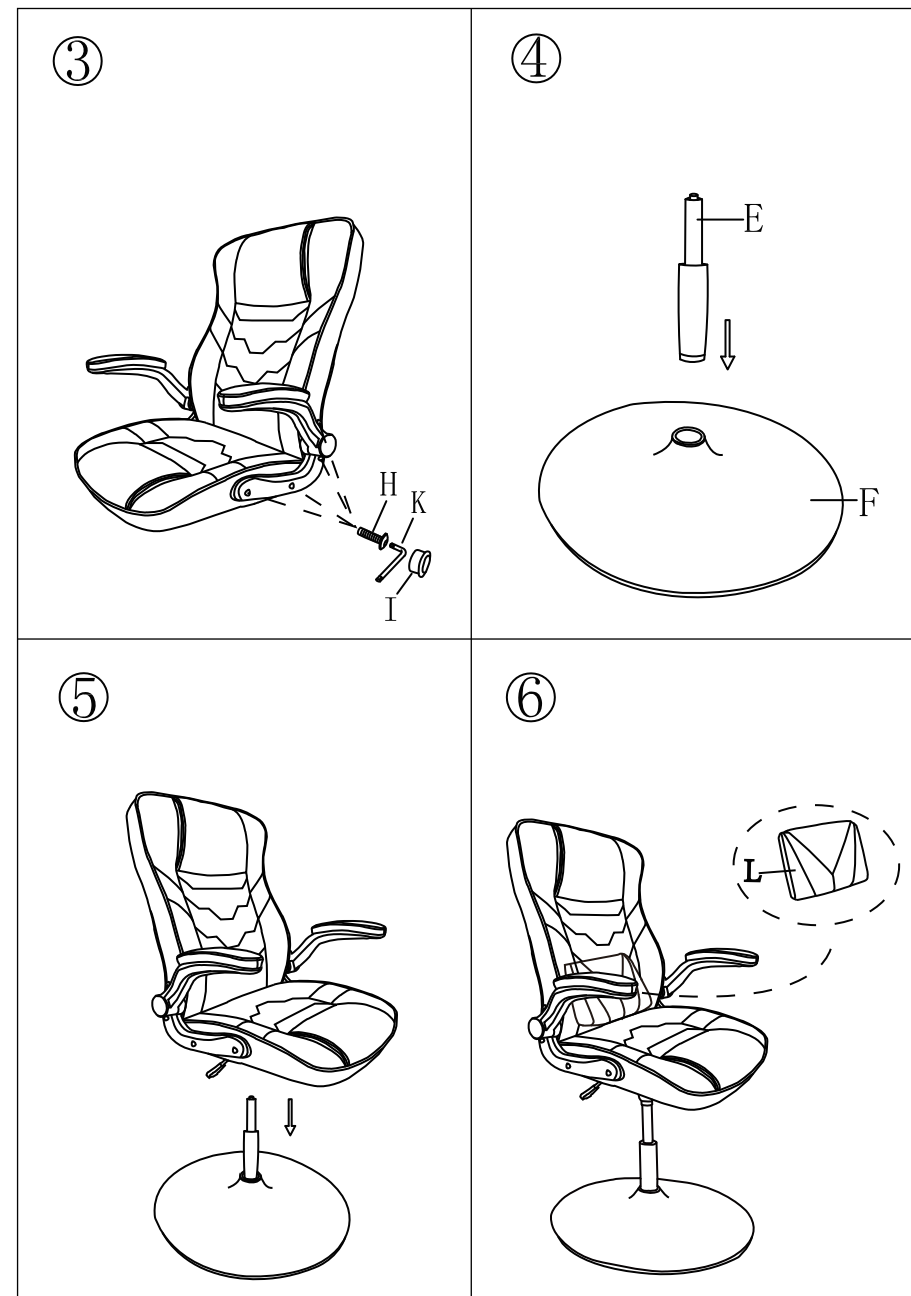
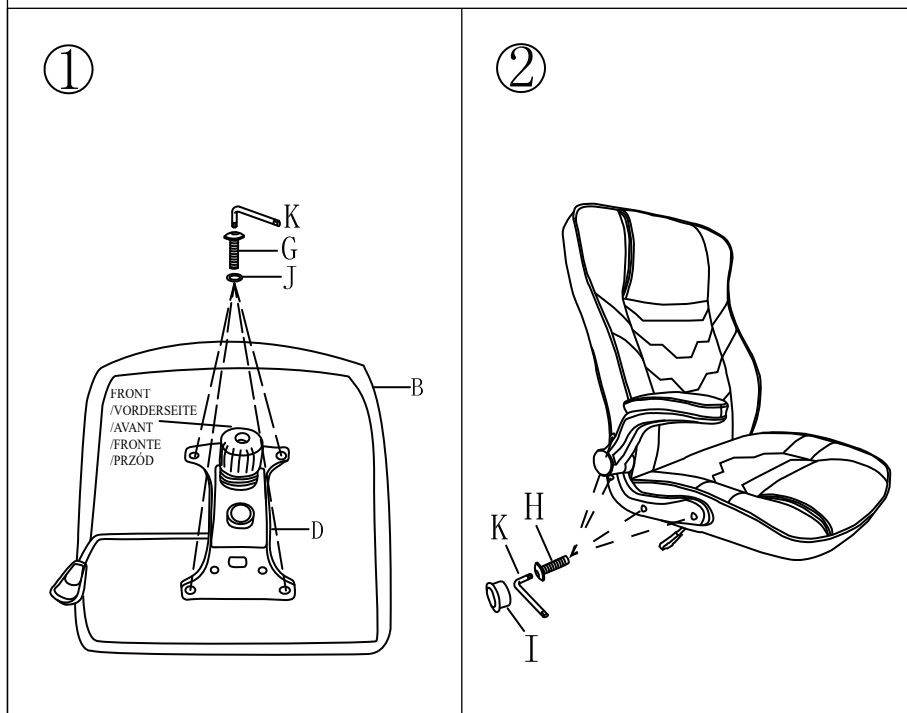

NOTE:

- 1) PLEASE USE SCREW "H" TO ASSEMBLE THE ARMS, SEAT AND BACK
- 2) DO NOT TIGHTEN ALL SCREWS UNTIL FULL ASSEMBLY

HINWEIS: 1) BITTE SCHRAUBE „H“ VERWENDEN, UM DIE ARME, DEN SITZ UND DEN RÜCKEN ZU MONTIEREN

- 2) ZIEHEN SIE NICHT ALLE SCHRAUBEN BIS ZUR VOLLSTÄNDIGEN MONTAGE FEST

REMARQUE :

- 1) VEUILLEZ UTILISER LA VIS « H » POUR ASSEMBLER LES BRAS, LE SIÈGE ET LE DOSSIER
- 2) VEUILLEZ NE PAS SERRER TOUTES LES VIS AVANT L'ASSEMBLAGE COMPLET

NOTE:

- 1) SI PREGA DI UTILIZZARE LA VITE "H" PER ASSEMBLARE LE BRACCIA, IL SEDILE E LA SCHIENA.
- 2) NON STRINGERE TUTTE LE VITI FINO AL COMPLETO ASSEMBLAGGIO.

UWAGA :

- 1) NALEŻY UŻYWAĆ ŚRUBY „H” DO MONTAŻU RAMION, SIEDZENIA I OPARCIA
- 2) PROSIMY NIE DOKRĘCAĆ WSZYSTKICH WKRĘTÓW PRZED UKOŃCZENIEM MONTAŻU