

A

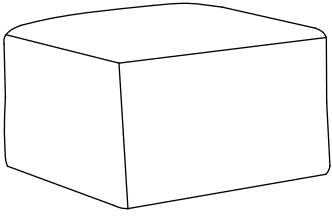

B

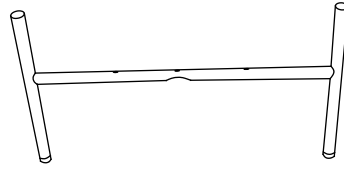

C

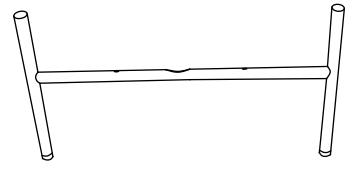

D

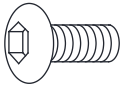

M6*18
1PC

E

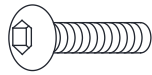

M6*35
4PCS

F



M6

1

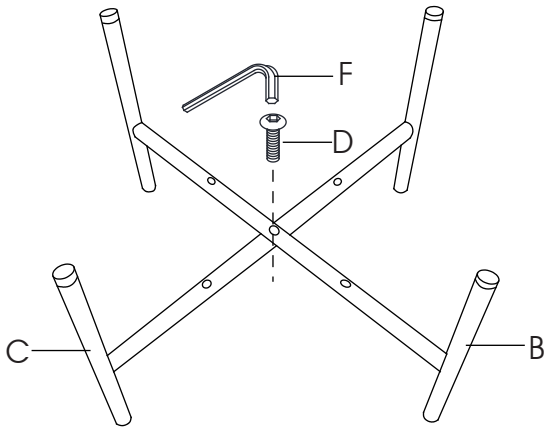

2

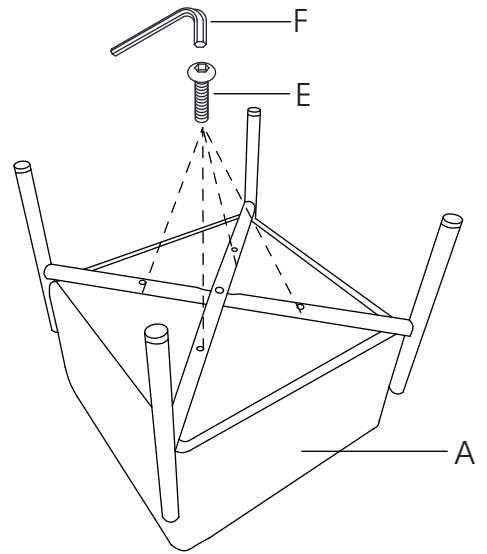

3

