





Assembly Instruction

Hardware and Component List:

No.	Hardware/Component List	Quantity
1	 Table Top	01
2	 Base	03
3	 Allen Bolt M8X30MM	06
4	 Washer 10X25MM	06
5	 Allen Key 5MM	01

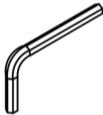
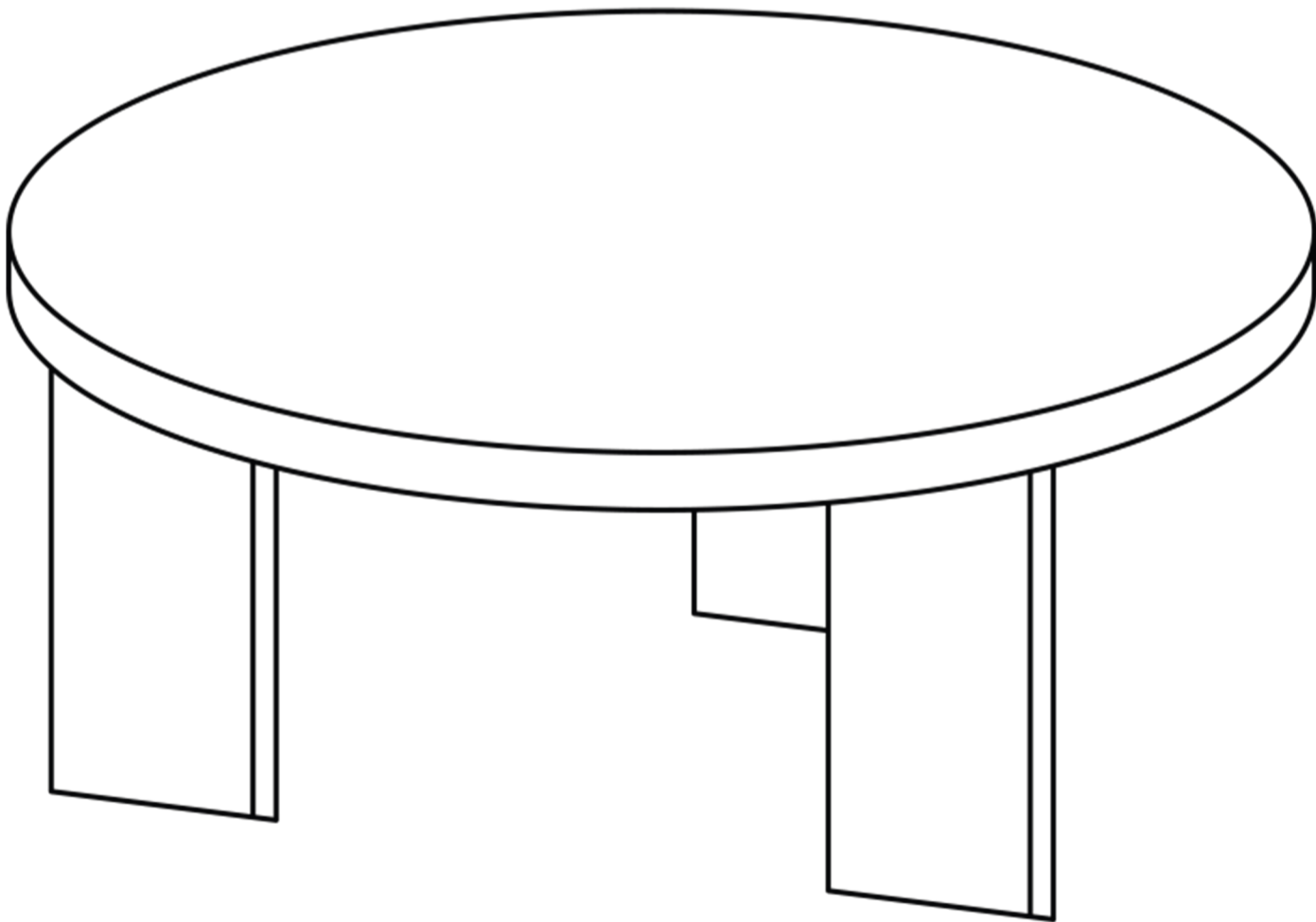

Assembly Instruction

1

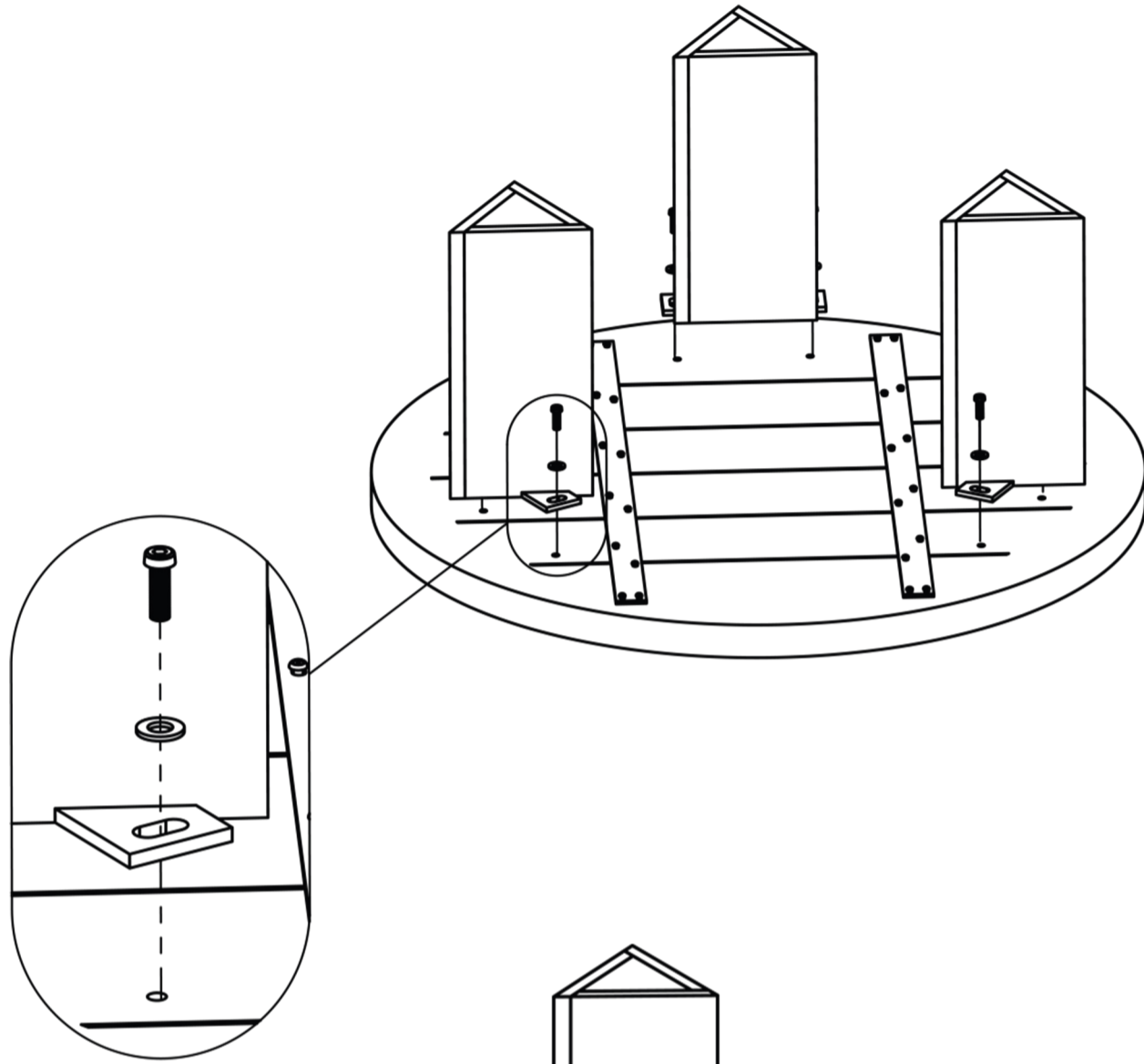

2

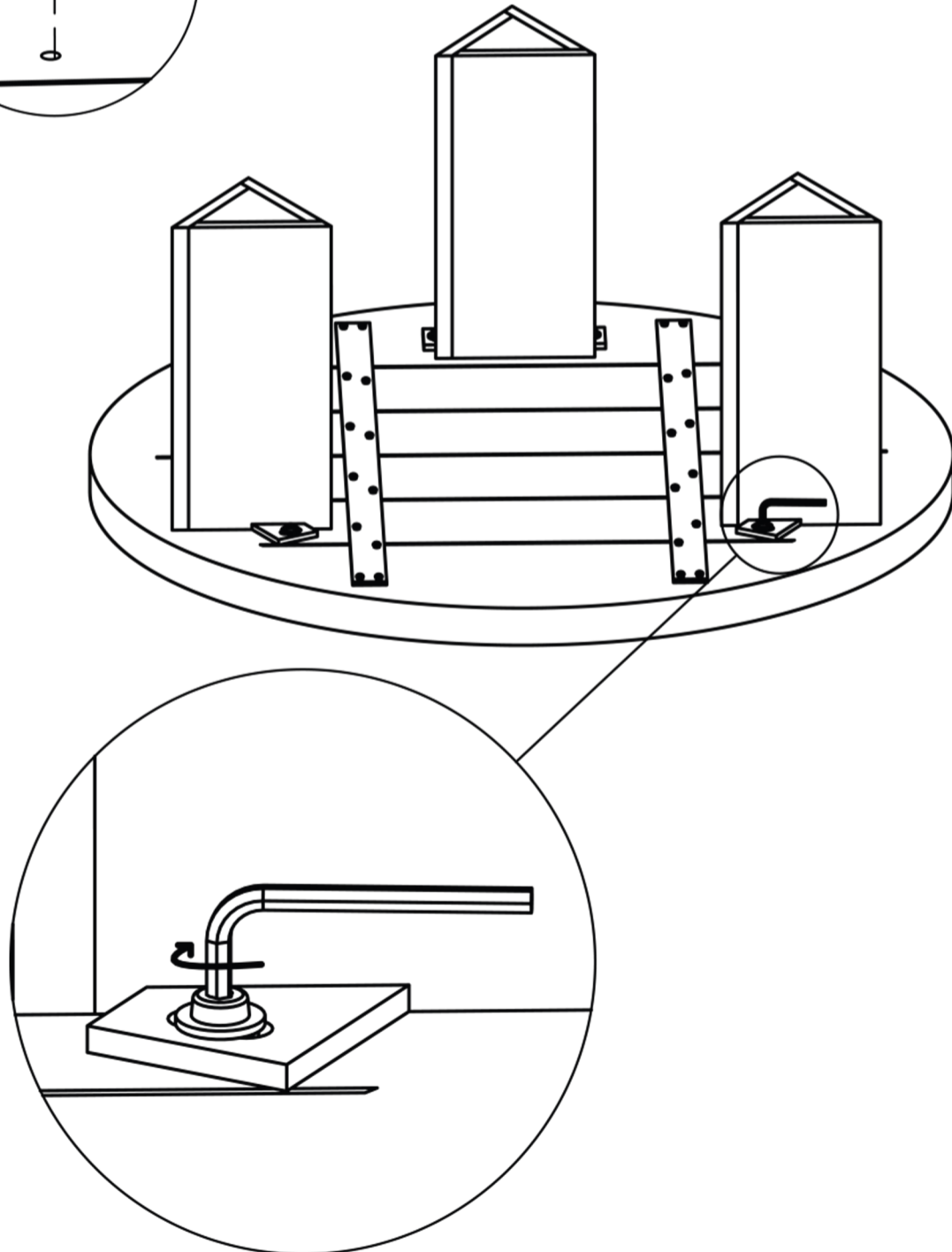

CAUTION : Assemble the product on a mat or carpet.