

Conservez ce manuel pour usage ultérieur  
*Save this manual for future reference*



1-833-411-7372

[www.SeraBathroomDesigns.com](http://www.SeraBathroomDesigns.com)

CONSERVEZ CES INFORMATIONS  
KEEP THIS INFORMATION

Date d'achat / Purchase date :

\_\_\_\_\_

Suivi et Référence du Produit  
Product Tracking Reference

\_\_\_\_\_



1-833-411-7372

**Thank you for your business.**

If you experience difficulties with this product, do not return to the point of purchase. Please contact SERA BATHROOM DESIGNS directly, and we will replace defective parts free of charge.

.....

**Nous vous remercions pour votre achat.**

Si vous éprouvez des difficultés avec ce produit, ne le retournez à son point d'achat. Veuillez contacter SERA BATHROOM DESIGNS directement, et nous allons remplacer les pièces défectueuses a nos frais!

.....

**Gracias por su compra.**

Si usted tiene problemas con este producto, por favor de no regresarlo al mismo lugar donde lo adquirió. Contáctarse con la empresa SERA BATHROOM DESIGNS y reemplazarán las piezas defectuosas sin cargo.

1-833-411-7372



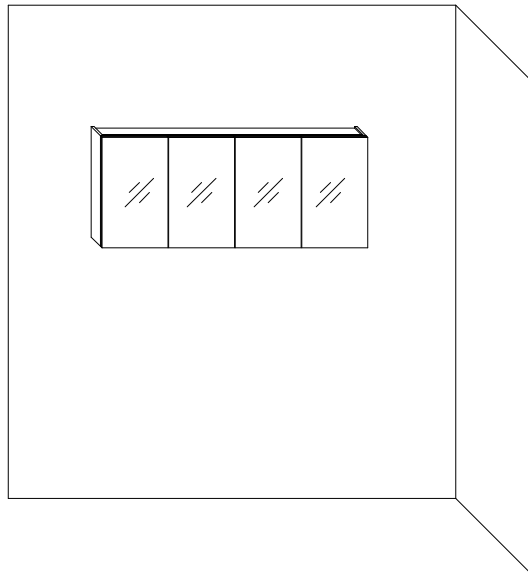

[www.SeraBathroomDesigns.com](http://www.SeraBathroomDesigns.com)

# Installation d'installation Installation Instruction



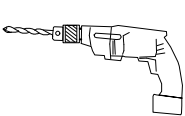
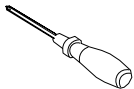
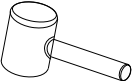

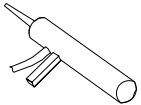
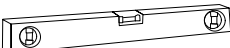
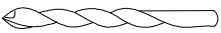
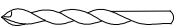
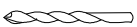
## GEN60MWTMC



### Installation tools (Not include)/Outils d'installation (non inclus)

Name/Nom	Pic/Image	Name/Nom	Pic/Image
Electric Drill/ Perceuse Eledrique		Cross Screwdriver/ Tournevis Crucifome	
Hammer/ Marteau		Pencil/ Crayon	
Wrench/ Clé		Glass Cement/ Adhésif de Verre	
Levelling Rod/ Mire de Nivellement		Drill 10mm/ Foret 10mm	
		Drill 8mm/ Foret 8mm	
		Drill 6mm/ Foret 6mm	
Tapline/ Ruban à Mesuren			

### Sparements/Pièces

Name/Nom	Code	Pic/Image	Qty/Qté	Name/Nom	Code	Pic/Image	Qty/Qté
Plastic expand screw $\Phi 8$ / Vis d'expansion plastique $\Phi 8$	G		8	Self-tapping screw ( $\Phi 5 \times 60$ )/ Vis Autotarudeus ( $\Phi 5 \times 60$ )	H		8
Nylon gaskets/ Entretoises en nylon	I		8	Iron gaskets/ Joints de fer	J		8
Screwcap/ Bouchon à vis	K		8				

## Step 1/Étape 1

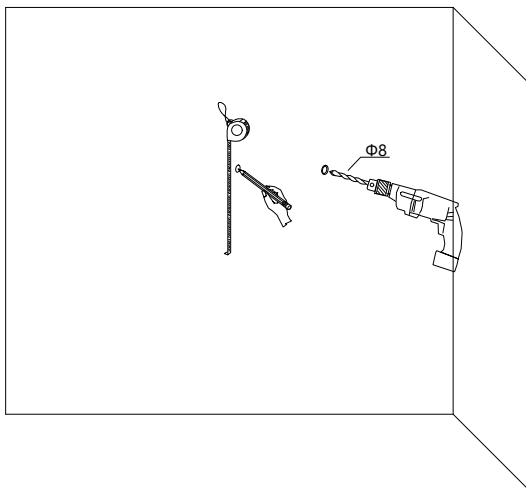

## Step 2/Étape 2

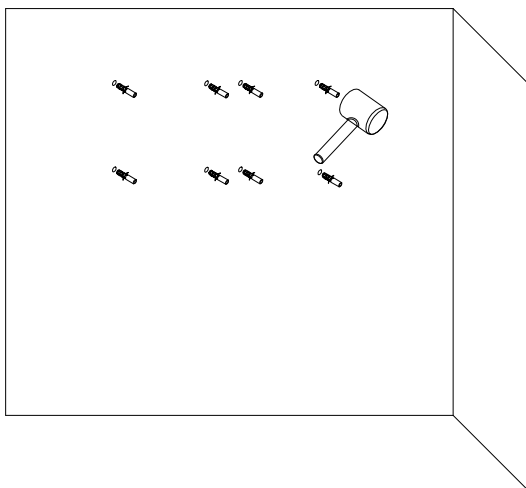

## Step 3/Étape 3

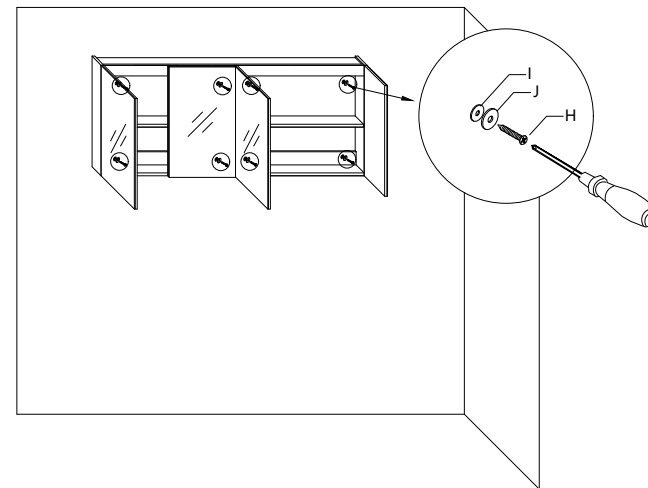

## Step 4/Étape 4

