



CAL LIGHTING

3625 E. Philadelphia St. Ontario CA. 91761 • Tel: 909.947.5200 • Fax:
909.947.5673 • www.calighting.com • service@calighting.com •
Specifications subject to change without notice

Type: _____

Project: _____

Catalog No.: _____

Lamp/Wattage: _____

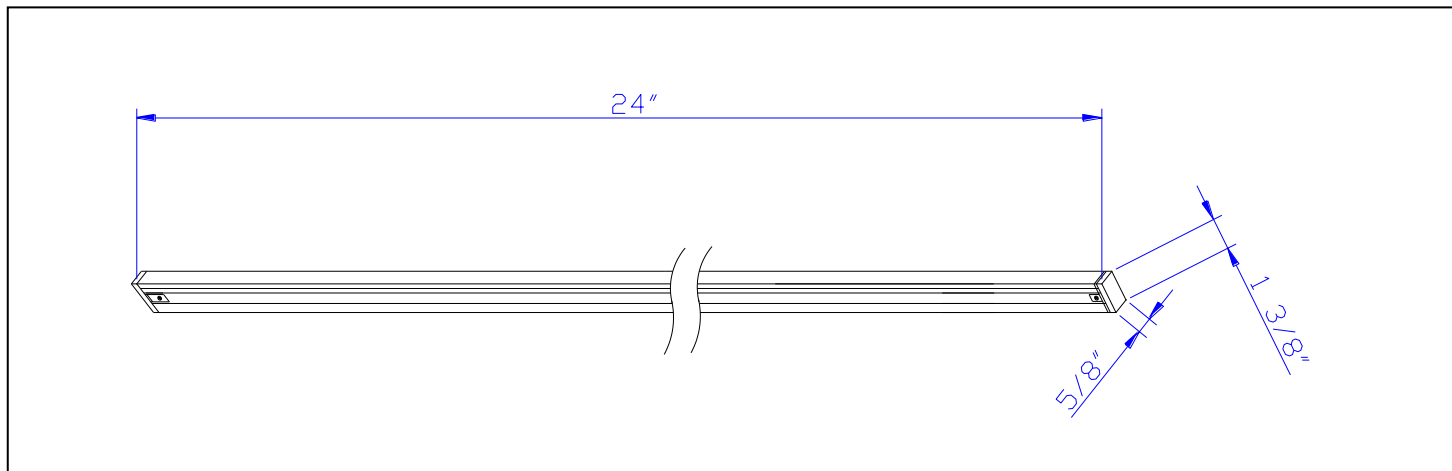

Model No. : HT-270

Description : 2' Track, 120V, 2400W

Voltage : 120 V

Ampere: 20 A

Finish : PB (Polished Brass)

Certificate : 