

PRODUCT DRAWING

A

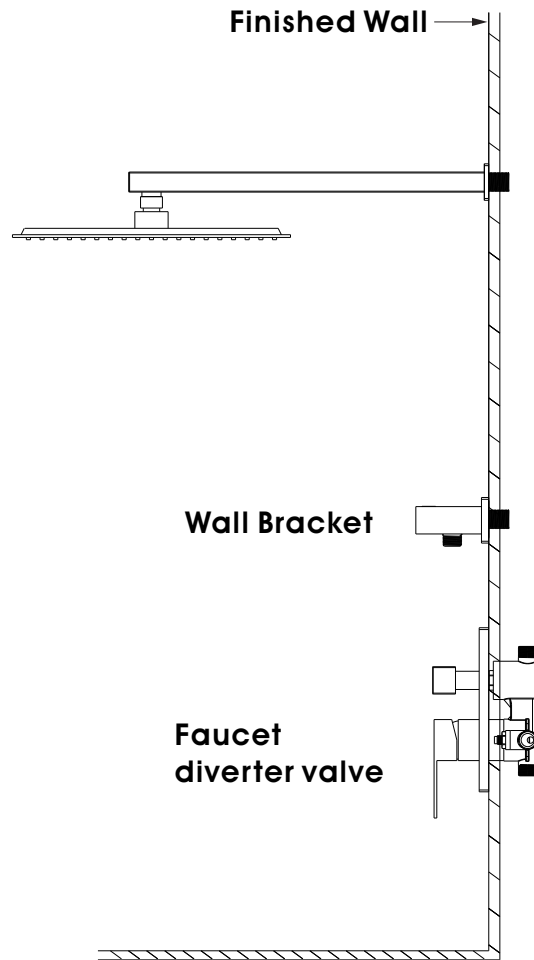

A

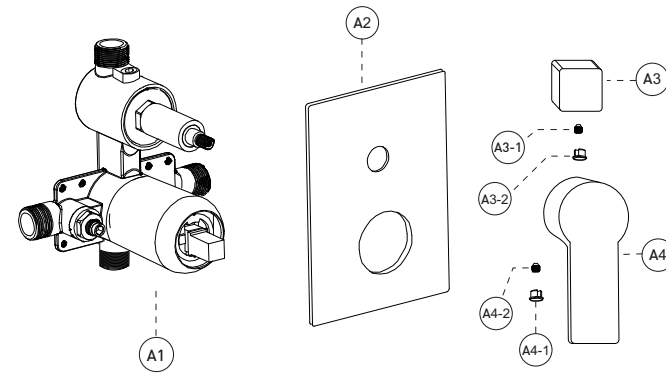

B

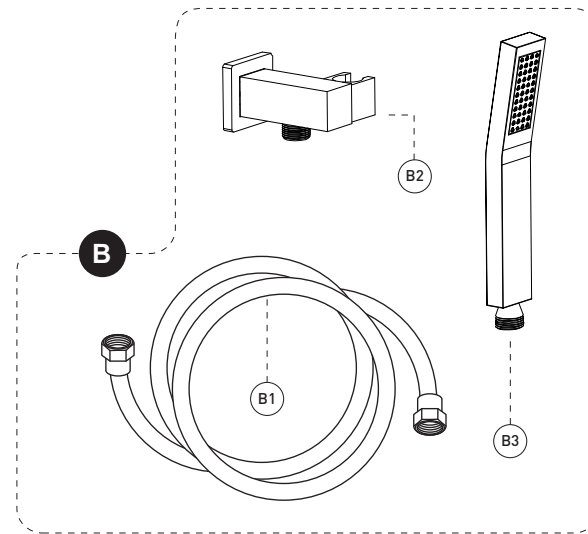



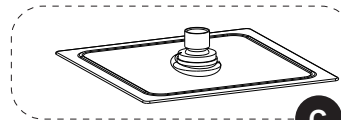



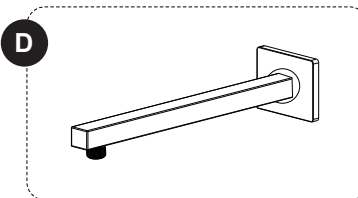











C



D



No.	Description				
A	Pressure balanced diverter valve				
A1	Valve				
A2	Face plate with sealjoint				
A3	Diverter knob kit				
A3-1	Allen screw (A-3 included)				
A3-2	Trim cap (A-3 included)				
A4	Shower valve handle				
A4-1	Trim cap (A-4 included)				
A4-2	Allen screw (A-4 included)				
B	Handheld Shower Kit with Flexible Hose				
B1	Flexible hose				
B2	Wall Bracket				
B3	Handheld Shower				
C	Shower head				
D	Shower arm and flange kit				
Z	Accessories Package				
<table border="1"> <thead> <tr> <th>For Repair And Warranty (Spare Parts)</th> <th>For Installation (Spare Parts)</th> </tr> </thead> <tbody> <tr> <td>    </td> <td>    </td> </tr> </tbody> </table>		For Repair And Warranty (Spare Parts)	For Installation (Spare Parts)	  	  
For Repair And Warranty (Spare Parts)	For Installation (Spare Parts)				
  	  				

SHOWER SYSTEM FAUCET

Installation instruction



MB/BN/BG/CH/ORB

CARE INSTRUCTIONS

Rinse the product with clear water. Dry the product with a soft cloth.

DO NOT:

Use abrasive cleansers, cloths, or paper towels. Use any cleaning agents containing acid, polish, wax, alcohol, ammonia, bleach, solvent or any other corrosive or harsh chemical cleansers.

INSTALLATION STEPS

! IMPORTANT

We recommends using a professional plumber for all installation and repair. Please inform yourself about the canadian plumbing code's regulations and your local municipality plumbing codes before installation. the canadian plumbing code requires the installation of surge arresting devices to eliminate water hammering. allow an adequate opening in order to easily access connections or other plumbing devices for maintenance or repair.

RECOMMENDED TOOLS



* Apply plumber's putty under the plastic cover deck plate to seal your installation.
Appliquez du mastic pour plombier sous la sous-plaque de plastique pour rendre votre installation étanche.

CONNECTION ADVICE

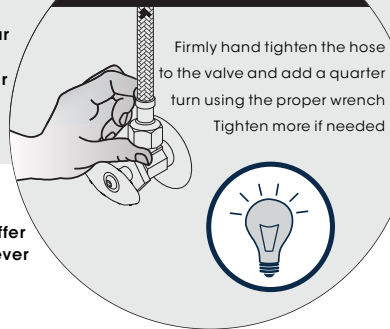

The model shown in the installation steps may differ from the one in box however connection type and installation steps are the same.

BEFORE YOU BEGIN

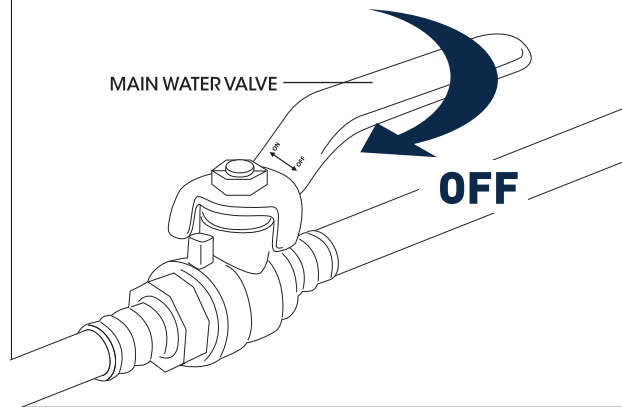

INSTALLATION WAY



A

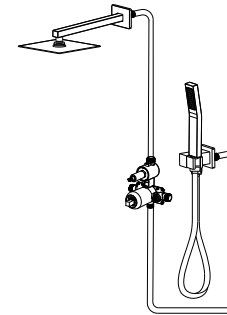

2

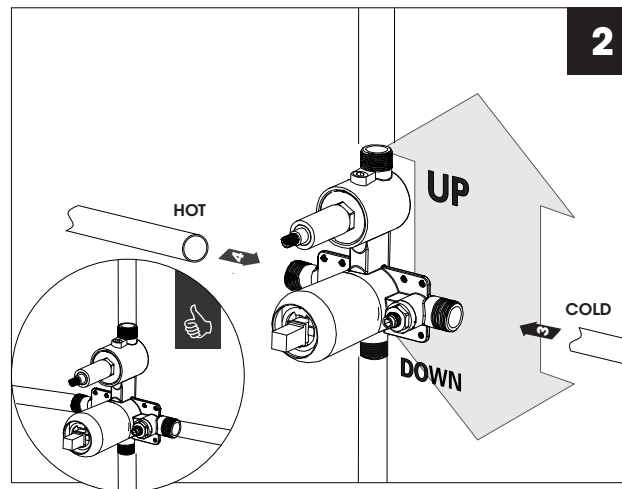

HEAD SHOWER

3

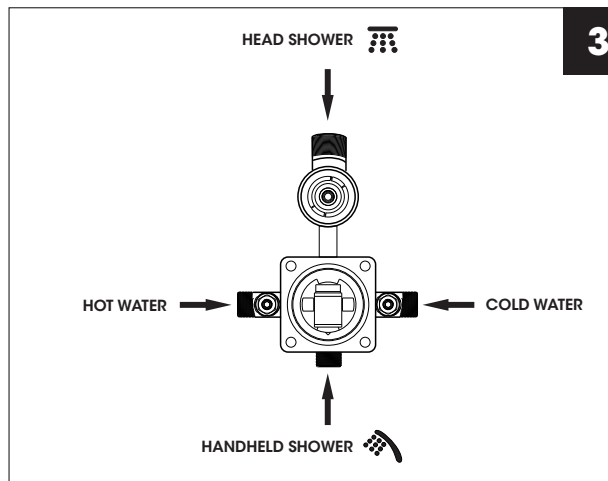

5

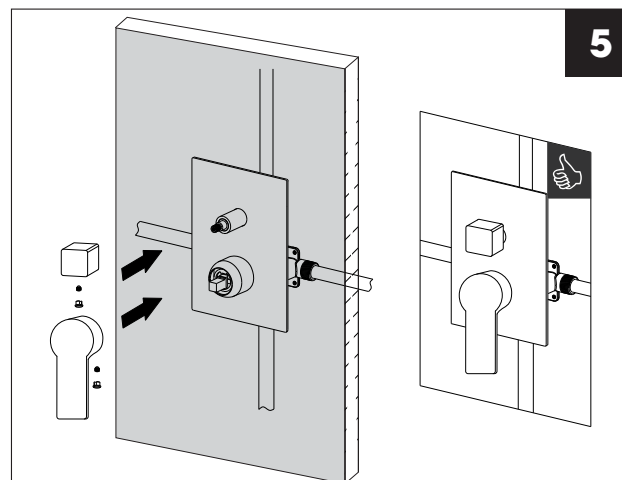

HEAD SHOWER

6

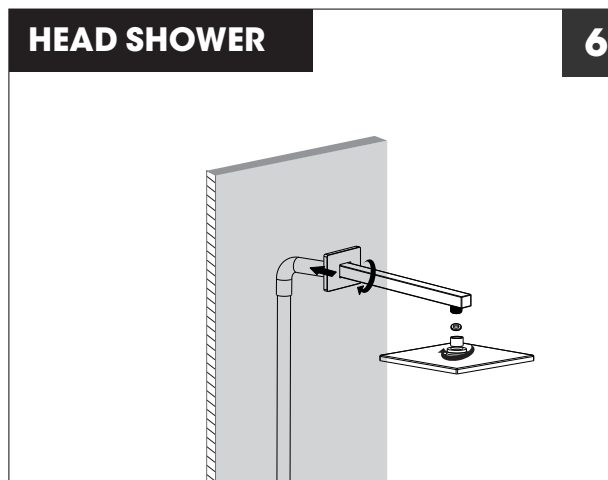

HANDHELD SHOWER

7

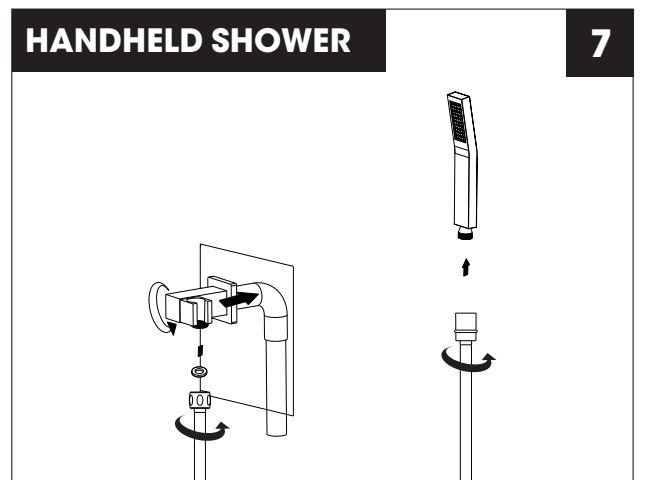

Rough-in-Installation primaire



ATTENTION
WHEN USING A HANDSHOWER, IT NEEDS TO BE CONNECTED TO THE TOP OUTLET

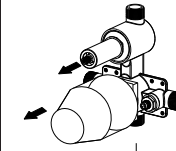

DRILLING GUIDE

