

Wall Mounted Lighted Makeup Vanity Mirror

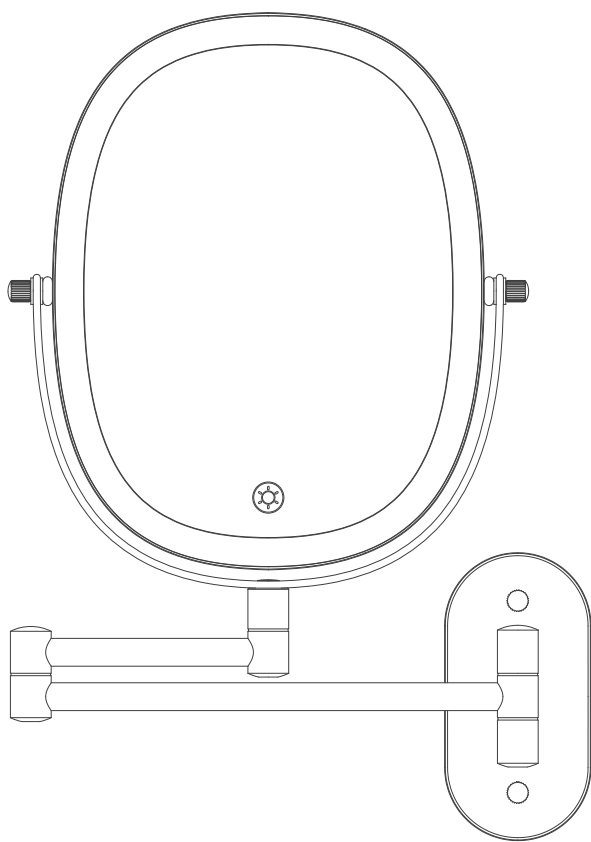

USER MANUAL

Wall Mounted Lighted Makeup Vanity Mirror

INSTALLATION

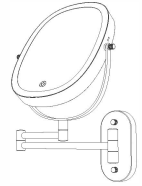

IMPORTANT SAFETY INSTRUCTION

⚠ WARNING – TO REDUCE THE RISK OF BURNS, FIRE, ELECTRIC SHOCK OR INJURY TO PERSONS:

- Please read this manual carefully before using the product.
- Please do not disassemble or modify the vanity mirror by yourself.
- Please make sure the battery is fully charged before use.
- Please check the voltage of the external power supply device to make sure it's compatible with this product before charging.
- Please turn off the power first before cleaning the mirror. The mirror should be cleaned with a soft cloth, and glass cleaner is OK to be applied on the mirror surface. Do not use corrosive chemicals to clean the surface of the mirror.
- Please wait for the mirror to be dry completely before turning on the light.
- Be sure the mirror is not in a position where it can reflect sunlight. Reflected sunlight may cause fire.
- Please provide close supervision when the mirror is being used near children or disabled persons.
- Do not approach the product to fire or put it into an ignition source to avoid fire or explosion.
- Please stop using it immediately if any abnormal condition occurs during the use of the product.

PLEASE SAVE THESE INSTRUCTIONS FOR FUTURE REFERENCE

Wall Mounted Lighted Makeup Vanity Mirror

INSTALLATION

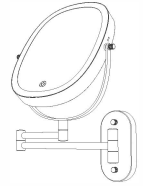

SPECIFICATIONS

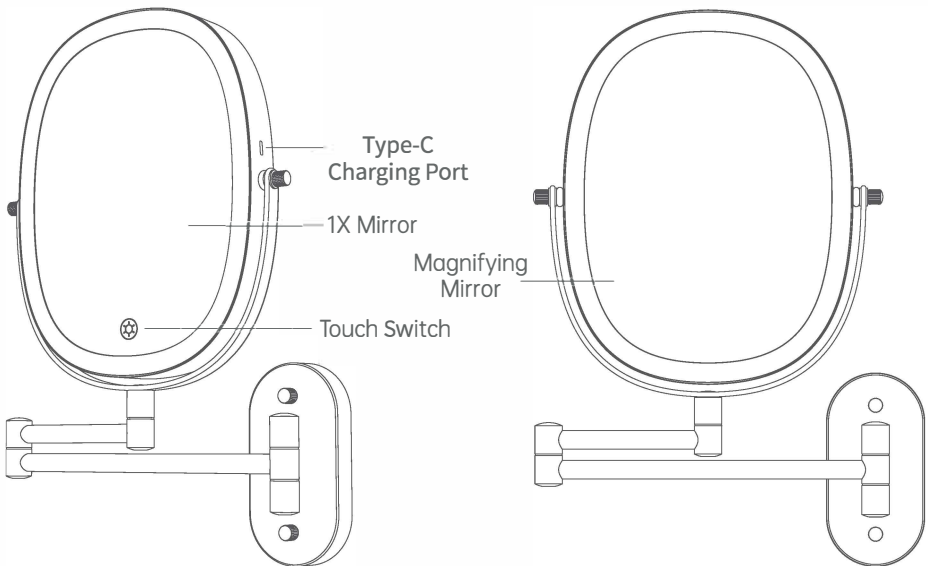

- Wall Mounted Lighted Makeup Vanity Mirror
- Magnifying Mirror and 1X Mirror
- Rechargeable 2000mAh Battery
- Dimmable with Touch Switch
- Color Temperature: 3500K-7000K±500K
- Material: Metal+Glass+ABS
- Mounting Type: Wall Mounted

Wall Mounted Lighted Makeup Vanity Mirror

INSTALLATION

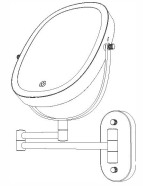

ACCESSORIES AND DIMENSIONS

PARTS INCLUDED

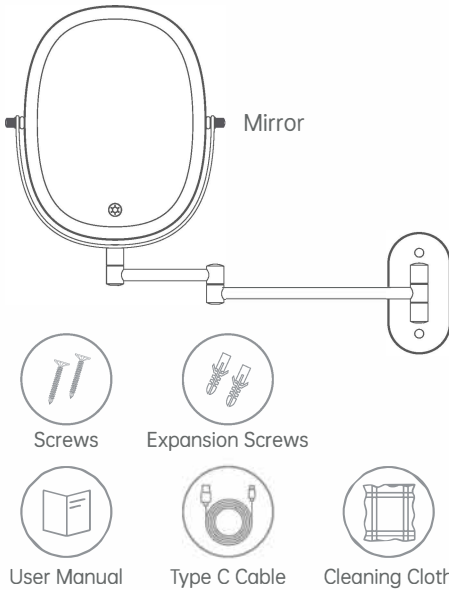

DIMENSION

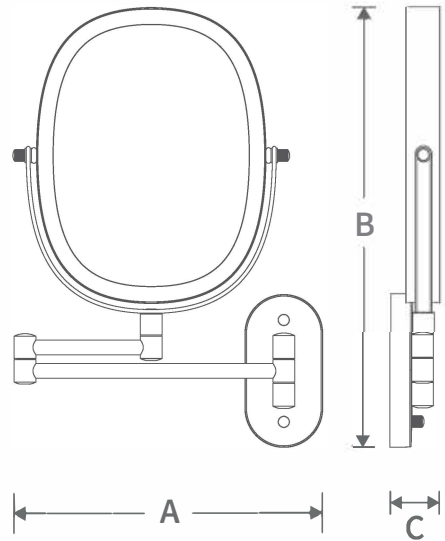

MODEL	A	B	C
01	9.59"	13.59"	1.52"

A Mirror's Width

B Mirror's Height

C Mirror's Depth

Wall Mounted Lighted Makeup Vanity Mirror

INSTALLATION

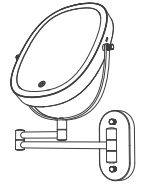

INSTALLATION METHOD

Refer to the following picture for installation

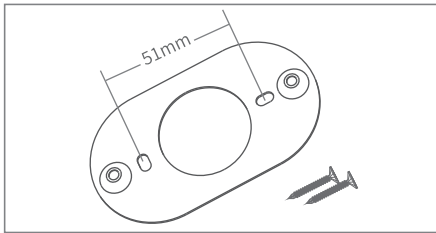

1 Unscrew the 2 screws caps and remove the base panel.

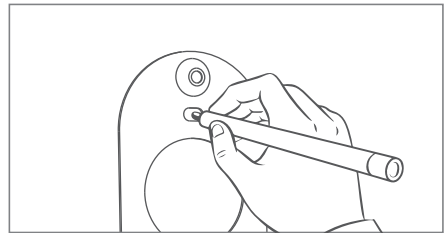

2 Choose a desired location to install. Mark 2 of the holes against the wall.

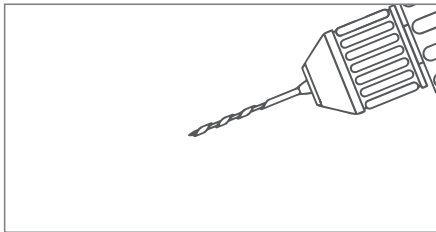

3 Drill holes according to the marked positions (hole diameter 6 mm).

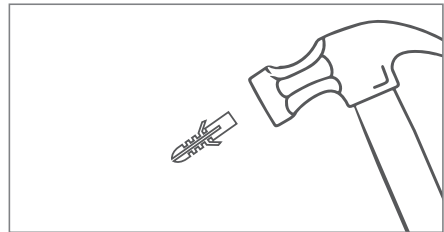

4 Install the 2 expansion anchor into the 2 holes.

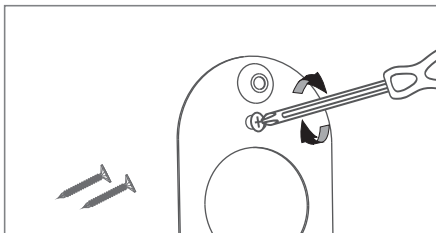

5 Apply base panel and install screws.

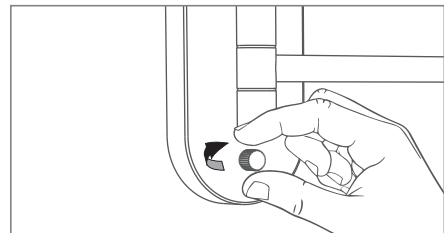

6 Secure the base with 2 screws.

Wall Mounted Lighted Makeup Vanity Mirror

INSTALLATION

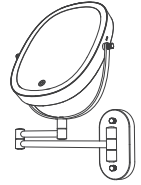

INSTALLATION AND OPERATION GUIDE

1 Please make sure the mirror is fully charged before use.

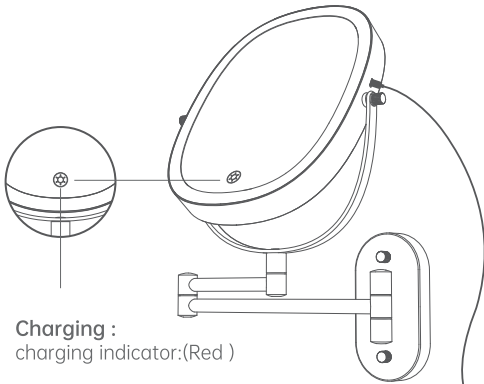

Charging :
charging indicator:(Red)

Full charged:
charging indicator:(Blue)

2 How to use this switch:

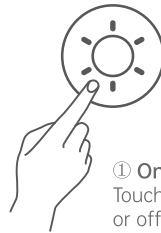

① On/Off Lights

Touch the switch to turn the light on or off.

② Adjustable Brightness

Long press to adjust brightness.

③ Change Color Temperature

Short press to select warm white or natural white light or daylight as you need.

How to use magnifying mirror



4inch



Viewing distance WITHIN 4 inch to avoid dizziness

Notes: Please make viewing distance within 4 inch to avoid dizziness and inverted image

(When you are further from the mirror, the image is inverted. As you get closer, the image flips to the actual virtual image in magnification standard. This is because of the concave lens of the Magnifying Mirror.)

⚠ Please make sure the mirror is fully charged before use.

Wall Mounted Lighted Makeup Vanity Mirror

INSTALLATION

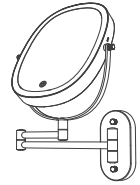

TROUBLESHOOTING

PROBLEM	POSSIBLE CAUSE	CORRECTIVE ACTION
LED light not working	Battery is depleted	Charge the battery
Battery not charging	Damaged charging cable	Replace with new charging cable
	Adapter not working	Replace with new adapter
The mirror will not stay in place	Screw loose	Tighten the screws

MIRROR MAINTENANCE:

1. Make sure that LED lights are OFF before cleaning.
2. Use a soft wet cloth to remove dirt and stains. Wipe with dry cloth afterwards.
3. You can use a velvet cloth for better result in cleaning (velvet cloth not included).
4. Be sure direct sunlight does not strike the mirror. When left unattended, reflected sunlight can cause fire.
5. To protect the mirror from dust simply store it in its original box.
6. Store out of reach of children in a safe dry location.



For your safety and continued enjoyment of this product, always read the instruction book carefully before using.

Wall Mounted Lighted Makeup Vanity Mirror

INSTALLATION

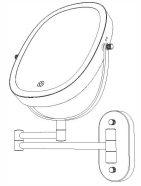

WARRANTY

Warranty Card

NAME

TEL

ADD

MODEL

ORDER NO

DATE

Failure Description
