

# 55" TV Stand with LED

Téléviseur LED 55 pouces

55" TV-Ständer mit LED

Supporto TV da 55" con LED

TV LED de 55 pulgadas

55"テレビスタンドとLED

55 英寸 LED 电视柜

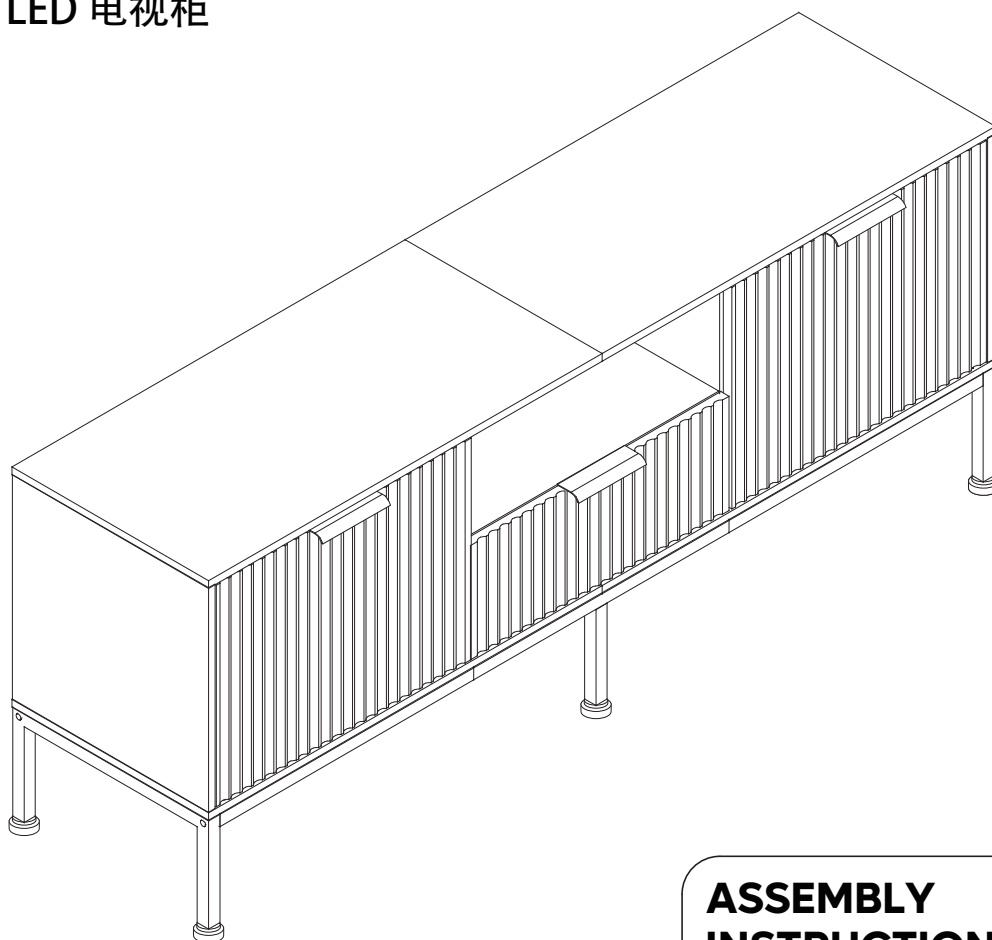

## ASSEMBLY INSTRUCTION

Montageanleitung  
Instructions De Montage  
Istruzioni Per L'assemblaggio  
Instrucciones De Montaje  
組立説明書  
安装说明书



## HELPFUL HINTS

### BEFORE YOU START

- Inspect product packaging to ensure the appearance is good.
- Read the assembly instruction carefully and follow it step by step.
- To avoid any scratching, putting a soft blanket on the floor is suggested.
- Identify, sort and count all the parts with tags.
- Find out installation position according to the drawing and install it in correct steps.

### OTHER

- People needed for assembly: 1-2.
- Estimated assembly time: 0.5-1h.

### CAUTION

- Be cautious when using a power drill or power screwdriver.
- Please be aware to slow down and stop when screw is nearly tight.
- Do Not use any harsh chemicals or abrasive cleaners for this item.
- Push, pull or drag this item carefully.

## ASTUCES UTILES

### AVANT DE COMMENCER

- Inspectez l'emballage du produit pour vous assurer que l'apparence est bonne.
- Lisez attentivement les instructions de montage et suivez-les étape par étape.
- Pour éviter toute rayure, posez une couverture douce sur le sol est suggéré.
- Identifiez, trie et comptez toutes les pièces avec des étiquettes.
- Trouver la position d'installation selon le dessin et l'installer dans les étapes correctes.

### AUTRE

- Personnes nécessaires pour l'assemblage : 1-2.
- Temps de montage estimé : 0.5-1 h.

### AVERTIR

- Soyez prudent lorsque vous utilisez une perceuse électrique ou un tournevis électrique.
- Veuillez être conscient de ralentir et d'arrêter lorsque la vis est presque serrée.
- N'utilisez pas de produits chimiques corrosifs ou de nettoyeurs abrasifs pour cet article.
- Poussez, tirez ou tirez cet article avec précaution.

## CONSEJOS ÚTILES

### ANTES DE EMPEZAR

- Inspeccione el paquete del producto para asegurarse de que la apariencia es buena.
- Lea atentamente las instrucciones de montaje y sígalas paso a paso.
- Para evitar rayas, se sugiere poner una manta suave en el suelo.
- Identifique, clasifique y enumere todas las piezas con etiquetas.
- Averigüe la posición de instalación según el dibujo e instálela en los pasos correctos.

### OTROS

- Personas necesarias para el montaje: 1-2.
- Tiempo de montaje estimado: 0.5-1 h.

### PRECAUCIÓN

- Tenga cuidado al utilizar un taladro eléctrico o un destornillador eléctrico.
- Tenga en cuenta que debe hacerlo más despacio y detenerse cuando el tornillo esté casi apretado.
- No utilice productos químicos agresivos ni limpiadores abrasivos para este artículo.
- Empuje, tire o arrastre este elemento con cuidado.

## SUGGERIMENTI UTILI

### PRIMA DI INIZIARE

- Controllare la confezione del prodotto per assicurarsi che sia in buono stato.
- Leggere con attenzione le istruzioni per l'assemblaggio e seguirle passo dopo passo.
- Per evitare graffi al pavimento, suggeriamo di stendervi una coperta morbida.
- Identificare, suddividere e contare tutte le parti con etichetta.
- Trovare la posizione adatta per il montaggio in base al disegno e montare lo scaffale seguendo correttamente i vari passaggi.

### ALTRO

- Persone necessarie per l'assemblaggio: 1-2.
- Tempo di assemblaggio stimato: 0.5-1 ora.

### ATTENZIONE

- Prestare molta attenzione quando si utilizza un trapano elettrico o un cacciavite elettrico.
- Rallentare con accortezza e fermarsi quando una vite è già sufficientemente serrata.
- Non utilizzare prodotti chimici aggressivi o detergenti abrasivi su questo articolo.
- Spingere, tirare o trascinare questo articolo con cautela.

## NÜTZLICHE HINWEISE

### ⚠ BEVOR SIE BEGINNEN

- Überprüfen Sie die Produktverpackung auf Schäden.
- Lesen Sie sich die Montageanleitung sorgfältig durch und befolgen Sie sie Schritt für Schritt.
- Um etwaiges Zerkratzen zu vermeiden, wird das Auslegen einer weichen Decke auf dem Boden empfohlen.
- Identifizieren, sortieren und zählen Sie alle Teile mit Tags nach.
- Identifizieren Sie die Montageposition gemäß der Zeichnung und bauen Sie das Regal den richtigen Schritten entsprechend auf.



### SONSTIGES

- Für den Zusammenbau erforderliche Anzahl an Menschen: 1-2.
- Ungefähre Montagedauer: 0.5-1 h.

### ⚠ VORSICHT

- Seien Sie bei der Verwendung einer Bohrmaschine oder eines Akkuschraubers vorsichtig.
- Bitte vergessen Sie nicht darauf, langsamer zu werden und zu stoppen, sobald die Schraube fast festgezogen ist.
- Verwenden Sie keinerlei aggressive Chemikalien oder scheuernden Reinigungsmittel für dieses Produkt.
- Schieben oder ziehen Sie dieses Produkt vorsichtig.

## 温馨提示

### ⚠ 安装前注意事项

- 检查产品包装，确保外观良好。
- 仔细阅读安装说明，按步骤操作。
- 为了避免刮伤，建议在地板上放一条柔软的毯子。
- 标识、分类和清点所有部件。
- 根据图形找到安装孔位，按正确步骤安装。



### 其他:

- 组装所需人员: 1-2人。
- 预计组装时间: 0.5-1小时。

### ⚠ 注意:

- 小心使用电钻或电动螺丝刀。
- 当螺丝快要拧紧时，请注意减速。
- 不要使用任何刺激性化学物质或擦洗剂。
- 当推、拉或拖动产品时，注意小心谨慎，防止损坏。

## 役に立つヒント

### ⚠ 組立の場所を確保し、順番通りに組み立てる

- 組立場所（充分広くて平たい場 所）を確保してください。
- 床や壁、商品を傷つけないように、商品の下に厚めの布や段ボールなどを敷いてください。
- 組立の順番を守らないと、組立できなくなったり、商品を傷つけたりします。



### その他

- 組み立てに必要な人: 1-2。
- 組立時間: 約0.5~1時間。

### ⚠ 部品を確認する

- ネジ類などの部品番号、形状を説明書の部品一覧で確認してください。
- 部品をなくさないように纏めて置いてください。
- 部品を取り出すときに使う分だけ取り出してください。

# DETAILS

DETAILS  
DÉTAILS/POINTS DE MONTAGE  
NOTE PARTICOLARI

DETALLES  
組み立てのポイント  
詳細情報

UNIT:INCH/CM/厘米

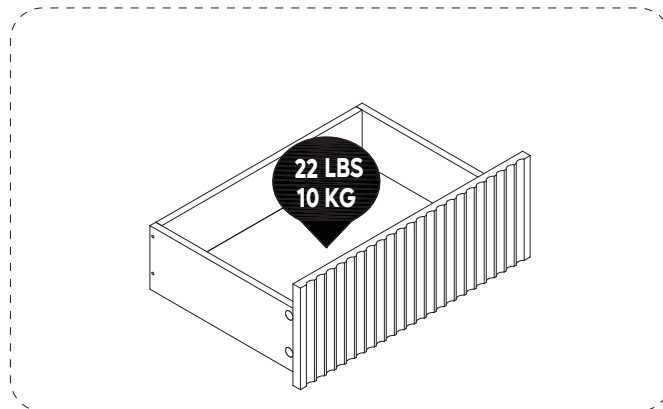
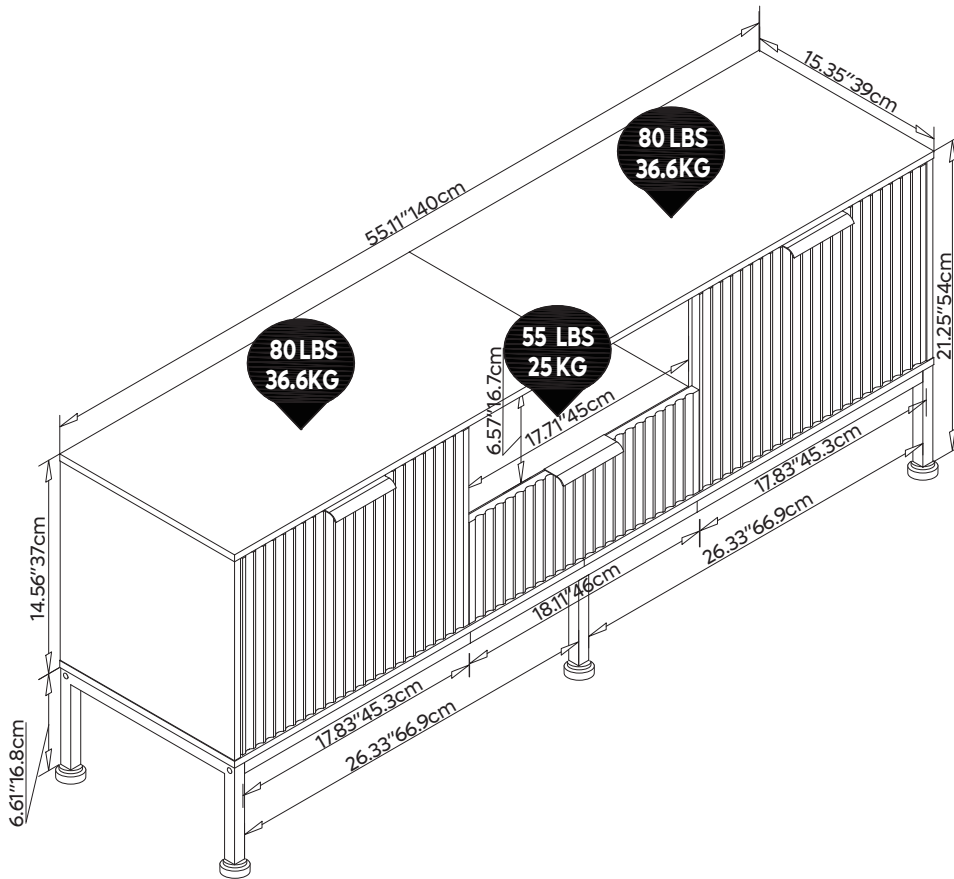

# DETAILS

DETAILS  
DÉTAILS/POINTS DE MONTAGE  
NOTE PARTICOLARI

DETALLES  
組み立てのポイント  
詳細情報

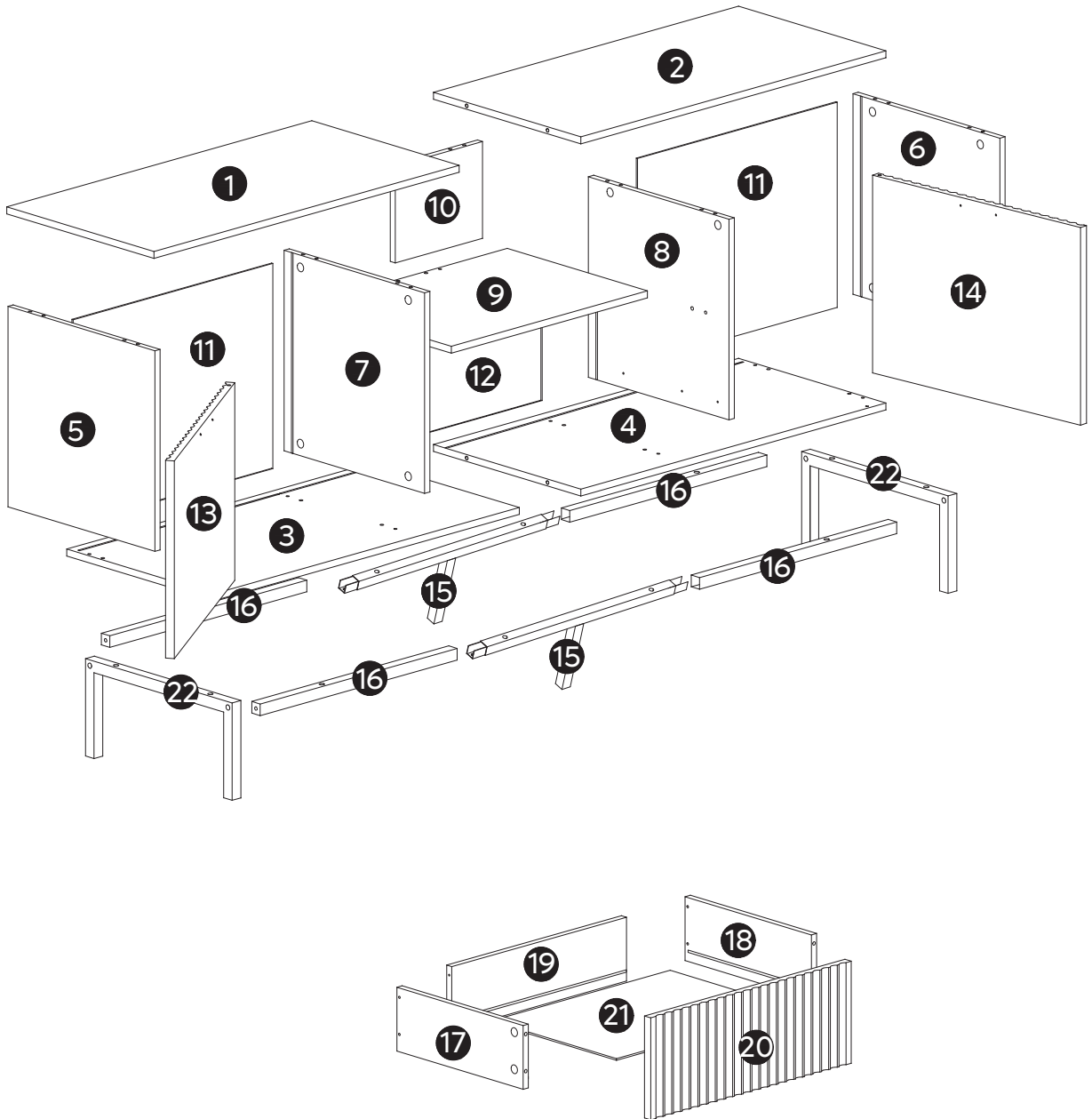

# PART LIST

STÜCKLISTE  
LISTE DES PIÈCES  
ELENCO DEI PEZZI

LISTA DE PIEZAS  
部品の確認  
部件清单

1

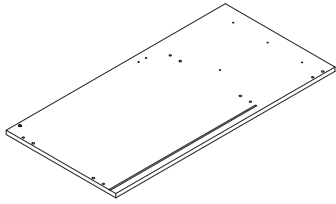

X1

2

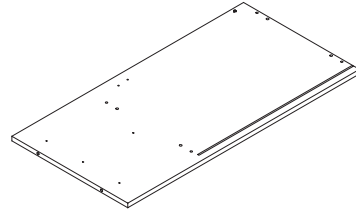

X1

3

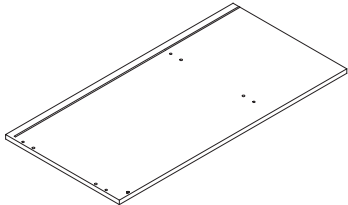

X1

4

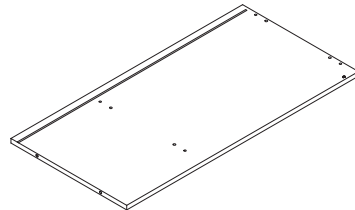

X1

5

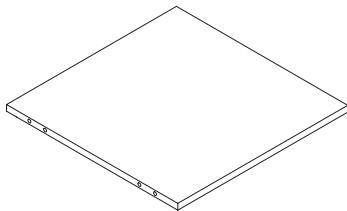

X1

6

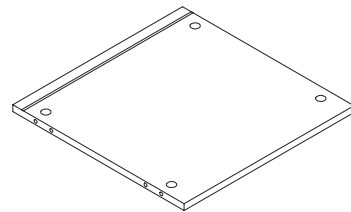

X1

7

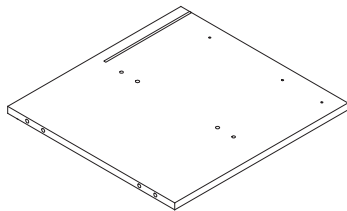

X1

8

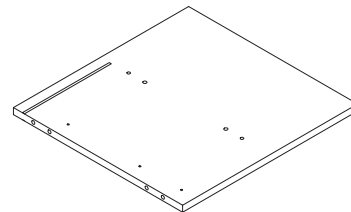

X1

9

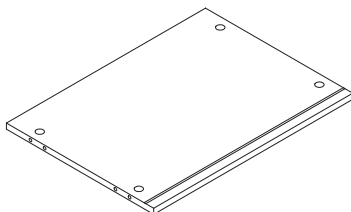

X1

10

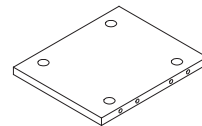

X1

11

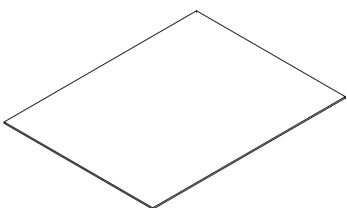

X2

12

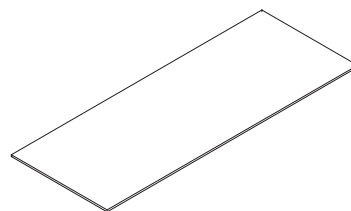

X1

# PART LIST

STÜCKLISTE  
LISTE DES PIÈCES  
ELENCO DEI PEZZI

LISTA DE PIEZAS  
部品の確認  
部件清单

13

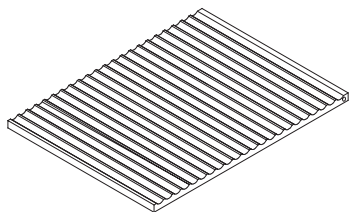

X1

14

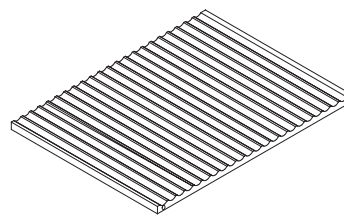

X1

15

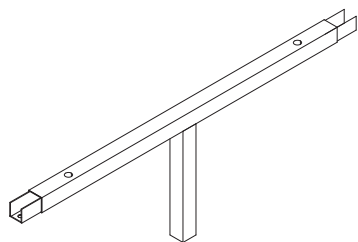

X2

16

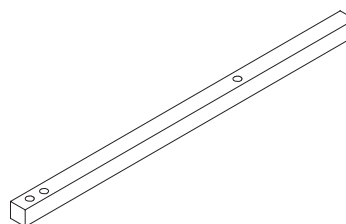

X4

17

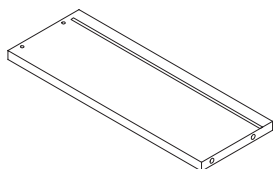

X1

18

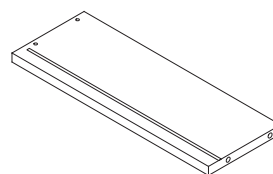

X1

19

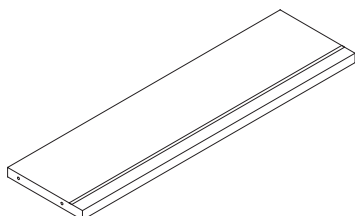

X1

20

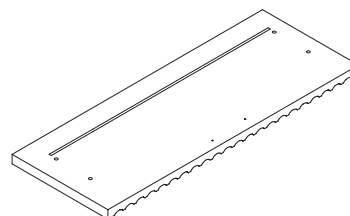

X1

21

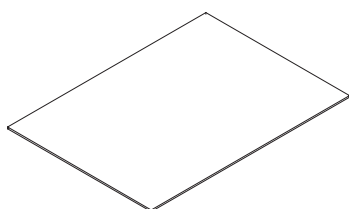

X1

22

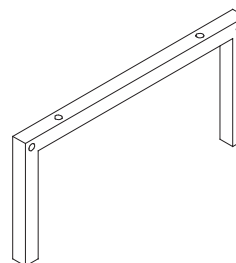









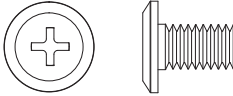
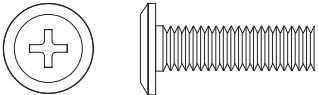
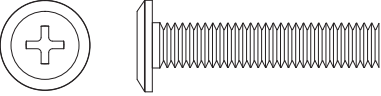

X2

# ACCESSORY LIST

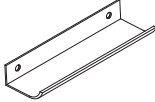
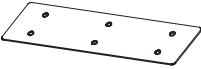
ZUBEHÖRLISTE  
LISTE DES ACCESSOIRES  
ELENCO DEGLI ACCESSORI













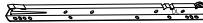

LISTA DE ACCESORIOS  
付属品部品の確認  
配件清單

<b>A</b>	Ø6x28mm	28+2	
<b>B</b>	Ø15x9.5mm	28+2	
<b>C</b>	ST6x30mm	24+2	
<b>D</b>	ST6x60mm	4+1	
<b>E</b>	M6x10mm	20+2	
<b>F</b>	M6x30mm	12+1	
<b>G</b>	M6x40mm	4+1	
<b>H</b>	ST3.5x12mm	34+2	
<b>I</b>	ST3.5x35mm	4+1	
<b>J</b>	/	3	
<b>K</b>	/	2	
<b>L</b>	400mm	1	
<b>M</b>	/	2+1	
<b>N</b>	ST3x8mm	2+1	

# ACCESSORY LIST

ZUBEHÖRLISTE  
LISTE DES ACCESSOIRES  
ELENCO DEGLI ACCESSORI

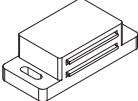
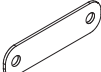
LISTA DE ACCESORIOS  
付属品部品の確認  
配件清單

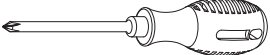
<b>O</b>	/	6	
<b>P</b>	300mm	1	<b>CL</b>  <b>DL</b>  <b>CR</b>  <b>DR</b> 
<b>Q</b>	/	4	
<b>R</b>	/	12+1	
<b>S</b>	/	2	    <b>S1</b> <b>S2</b> <b>S3</b> <b>S4</b>
<b>T</b>	/	28+2	
<b>U</b>	/	2	 
<b>V</b>	ST3x14mm	4+1	 
	/	1	

# Detailed Installation for Accessory A B

Installation détaillée pour l'accessoire A B  
 Detaillierte Installation des Zubehörs A B  
 Installazione dettagliata per l'accessorio A B  
 Instalación detallada del accesorio A B  
 カムロック取り付け方  
 配件A、B详细安装

**1**

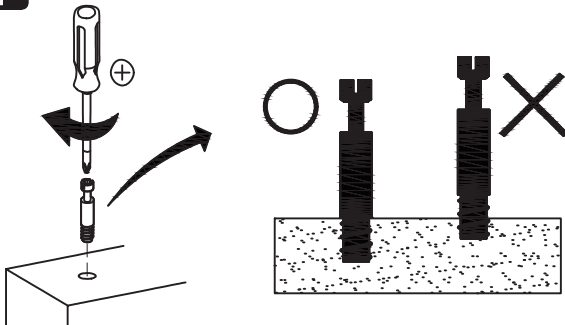

Screw cam dowel on the panel.  
 Vissez la goupille de came au panneau.  
 Nockendübel auf die Platte schrauben.  
 Avvitare il tassello a camme sul pannello.  
 tornillo de pasador de leva en el panel.  
 カムロックネジを部品に取り付ける。  
 螺杆用十字螺丝刀装入对应的预留孔内

**2**

Place another panel via the dowel.  
 Placez un autre panneau par le goujon.  
 Setzen Sie eine weitere Platte über den Dübel ein.  
 Posizionare un altro pannello tramite il tassello.  
 Coloque otro panel a través del pasador.  
 カムロックネジをカムロック穴に差し込む。  
 螺杆插入对应孔位，将两块板材对接起来。

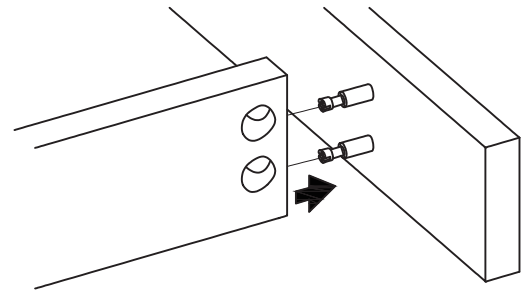

**3**

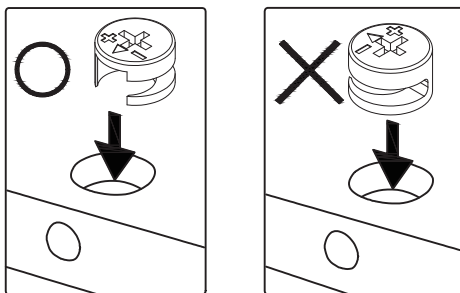

Pay attention to the direction of cam lock when putting it into hole.

Faites attention à la direction du verrou à came en entrant dans le trou.

Achten Sie auf die Richtung des Nockenschlosses, wenn Sie es in das Loch stecken.

Fare attenzione alla direzione della serratura a camme quando lo si inserisce nel foro.

Preste atención a la dirección de la leva de fijación al insertarla en el orificio.

カムロックネジの方向にカムロックの穴の穴の向きを合わせ取り付け。

装入锁扣圆盘，注意锁扣圆盘的方向；

Tighten up cam lock clockwise until it stops.

Serrez le verrou à came dans le sens des aiguilles d'une montre jusqu'à ce qu'il s'arrête.

Ziehen Sie die Nockenverriegelung im Uhrzeigersinn bis zum Anschlag an.

Stringere la serratura a camme in senso orario fino all'arresto.

Apriete la leva de fijación en sentido horario hasta el tope.

カムロックをドライバーで締め固定する。

顺时针旋转锁扣圆盘并锁紧。

**4**

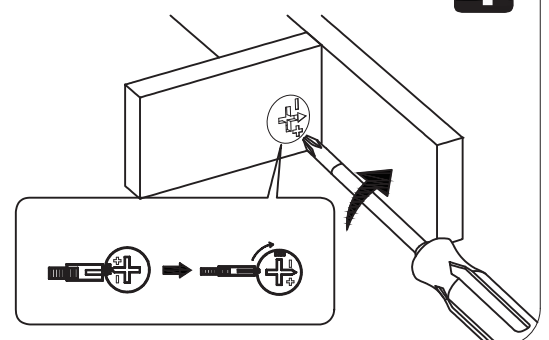

# Detailed Installation for LED Strip

Installation détaillée de la bande LED  
 Ausführliche Anbringungsanleitung für LED-Streifen  
 Installazione dettagliata della striscia LED  
 Instalación detallada de la tira de LED  
 LEDストリップライトの設置に関する詳細説明  
 LED 灯带安装方法

- Remove about 25mm (1") of adhesive tape at both ends of LED light strip.
- Retirez environ 25 mm de ruban adhésif à chaque extrémité de la bande lumineuse LED.
- An beiden Enden des LED-Streifens etwa 25 mm (1 Zoll) des Klebebandes entfernen.
- Rimuovere circa 25 mm di nastro adesivo su entrambe le estremità della striscia luminosa a LED.
- Retire unos 25 mm (1") de la cinta adhesiva en ambos extremos de la tira de luces LED.
- LEDストリップライトの両端にある粘着テープを約25mm (1") はがしてください。
- 揭开LED灯带两端的胶纸约25mm (1")。

1

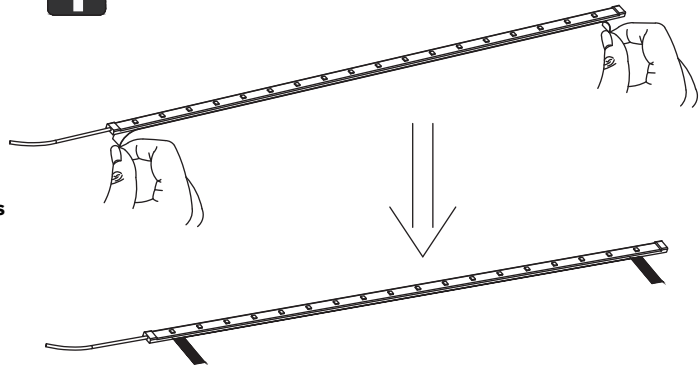

- The head and tail of the LED light strip are pasted in a straightline, and the fixing parts at both ends are locked with screws.
- Tête et queue du ruban LED collé sur une ligne droite, et les pièces de fixation situées à chaque extrémité sont sécurisées par des vis.
- Kopf und Heck des LED-Lichtstreifens sind in einer geraden Linie geklebt und die Befestigungselemente anschrauben.
- La testa e la coda della striscia luminosa LED sono incollati in un dritto Linea, e le parti di fissaggio ad entrambe le estremità sono bloccate con viti.
- La cabeza y la cola del cinturón de Luz LED se pegan en línea recta. Cable, las piezas de fijación en ambos extremos están cerradas con tornillos.
- LEDライトバンドの頭部と尾部を直線に貼り付けるワイヤ、両端の固定具はネジでロックします。
- LED灯带头尾呈直线粘貼,用螺丝将两端的固定件锁住。

2

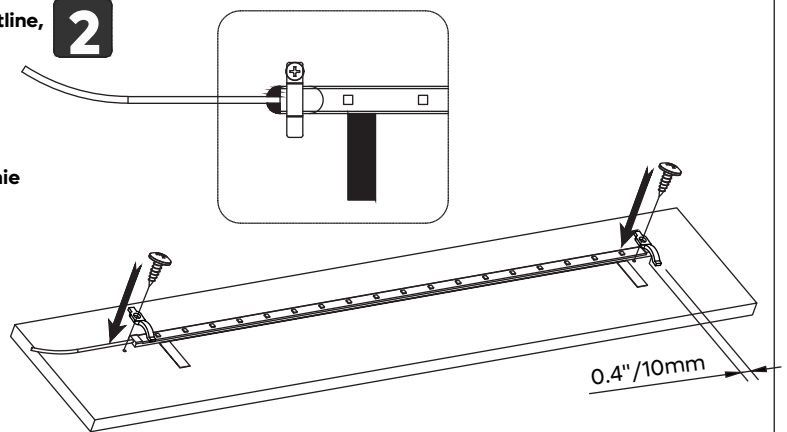

- Tear off the whole protective paper, and flatten the strip light so that the LED light strip is completely adhered to the wood.
- Arrachez tout le papier de protection et aplatissez la bande lumineuse de manière à ce que la bande lumineuse à DEL soit complètement collée au bois.
- Die gesamte Schutzfolie abziehen und den LED-Streifen so flach andrücken, dass er vollständig auf dem Holz aufliegt.
- Strappare l'intera carta protettiva e appiattire la striscia luminosa in modo da farla aderire completamente al legno.
- Retire todo el papel protector y aplane la tira de luz para que la tira de luz LED quede completamente adherida a la madera.
- 全体の保護ペーパーをはがしてLEDストリップライトを平らにして、木材に完全に貼り付けるようにします。
- 将整条保护纸撕掉,并压平整条灯带,使LED灯带完全粘在木板上。

3

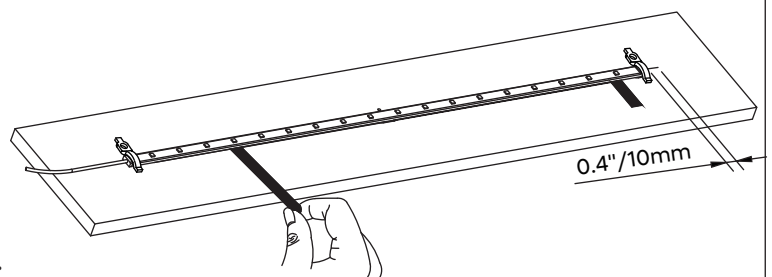

- Lock the remaining fixings.
- Verrouillez les autres fixations.
- Die restlichen Befestigungen anziehen.
- Bloccare i restanti elementi di fissaggio.
- Bloquee las fijaciones restantes.
- 残りの固定具を留めます。
- 锁上剩下的固定件。

4

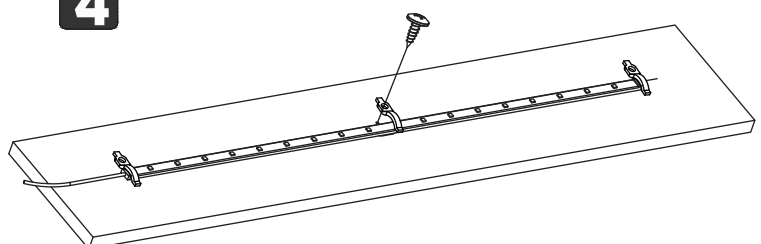

1

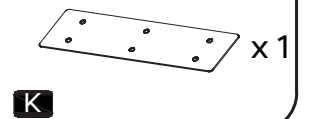
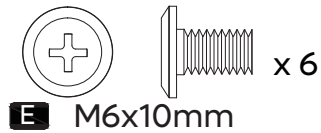
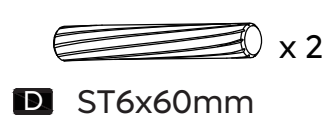
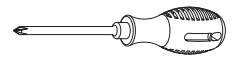
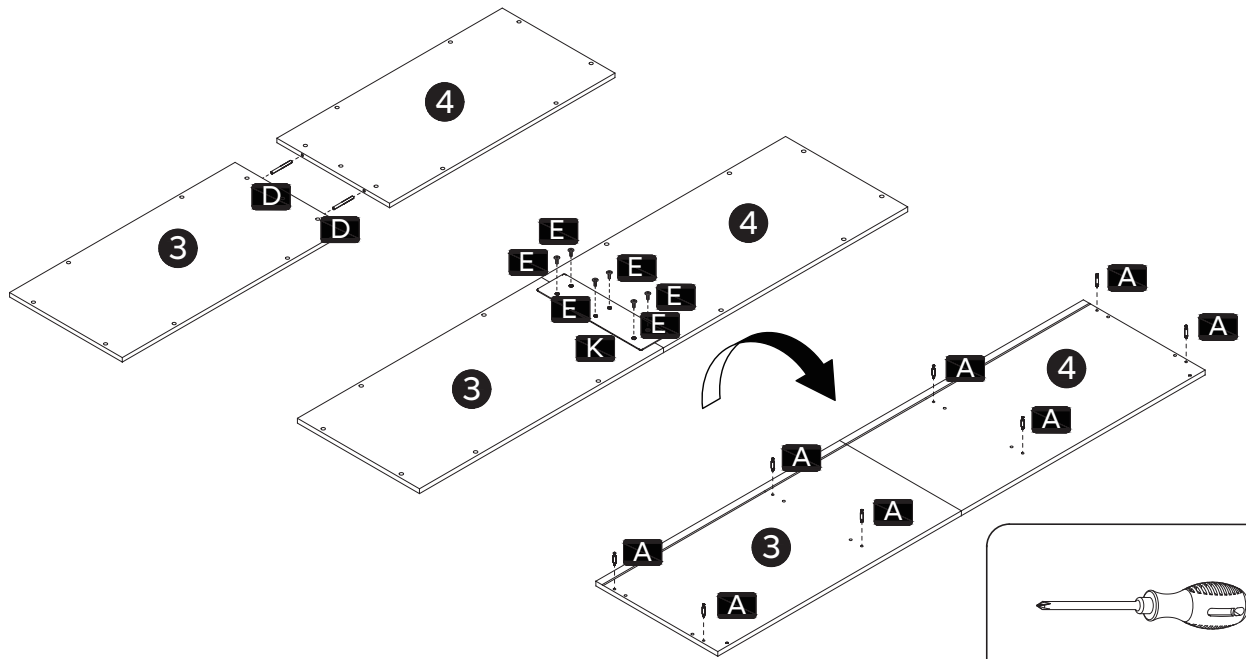

2

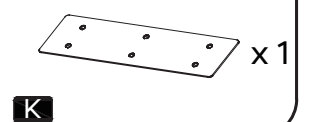
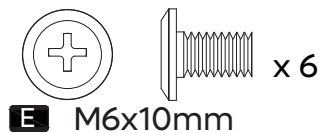
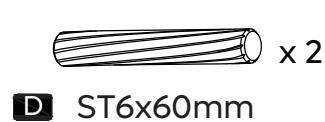
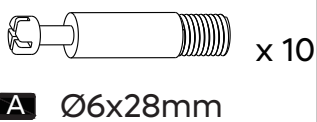
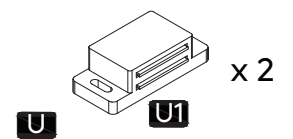
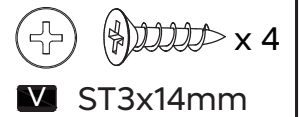
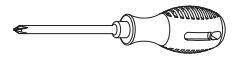
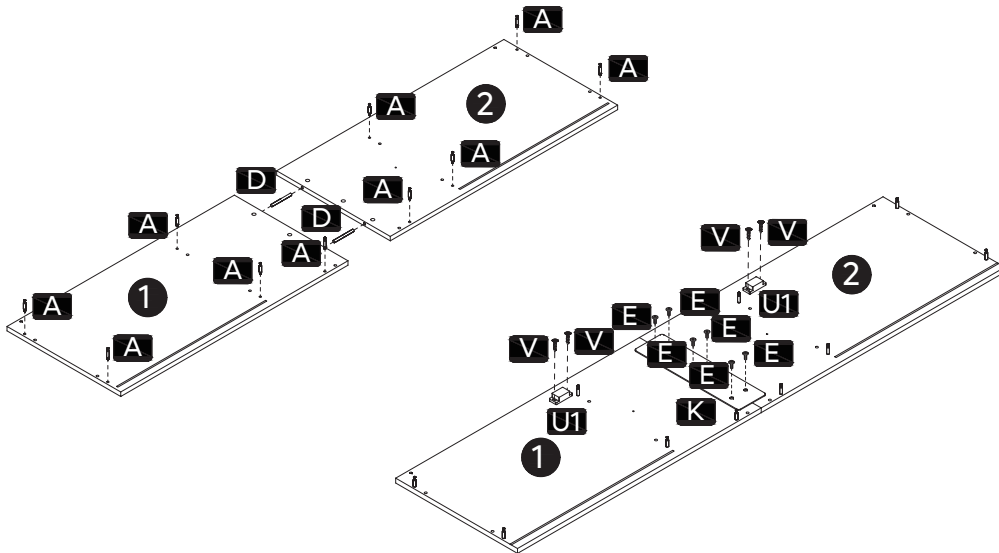

### 3

- Please refer to "Detailed Installation for LED Strip" on page "11".
- Veuillez consulter "Installation détaillée de la bande LED" sur la page "11".
- Siehe Seite "11" der "Ausführlichen Anbringungsanleitung für LED-Streifen".
- Fare riferimento a "Installazione dettagliata della striscia LED" a pagina "11".
- Consulte "Instalación detallada de la tira de LED" en la página "11".
- "11"ページにある"LEDストリップライトの設置に関する詳細説明"を参照してください。
- 请参考第 "11" 页 "LED 灯带安装方法"

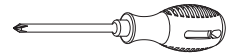
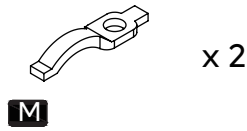
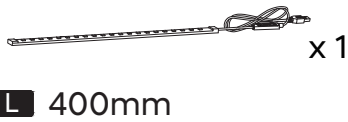
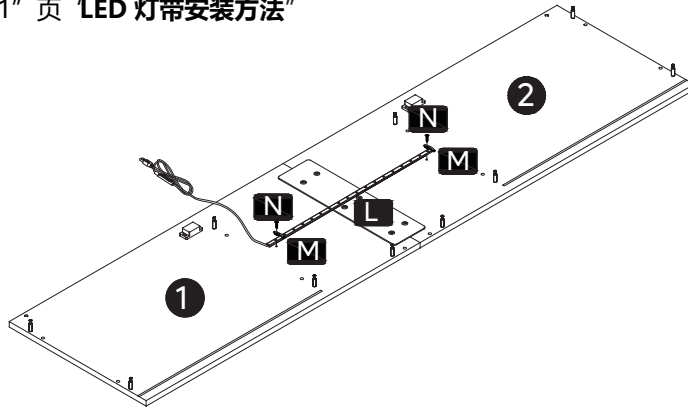

### 4

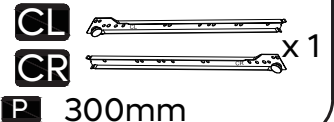
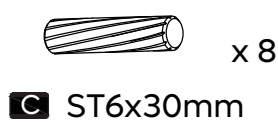
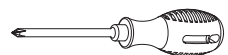
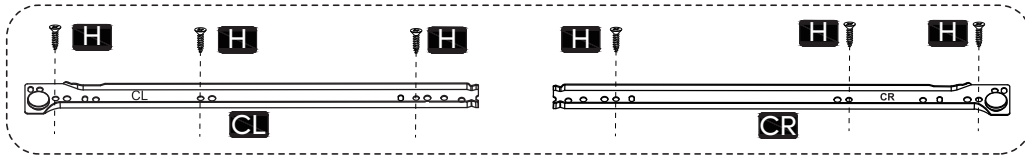
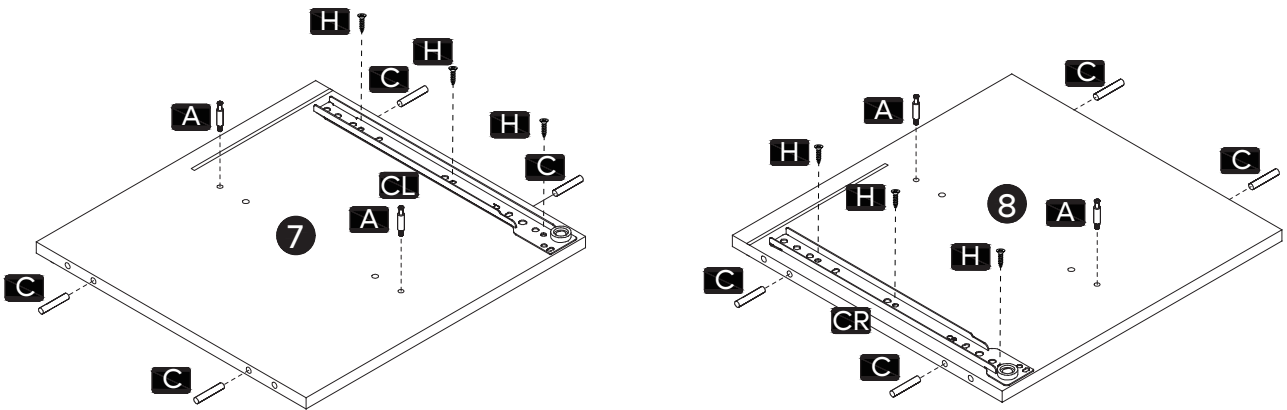

# 5

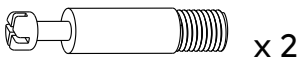
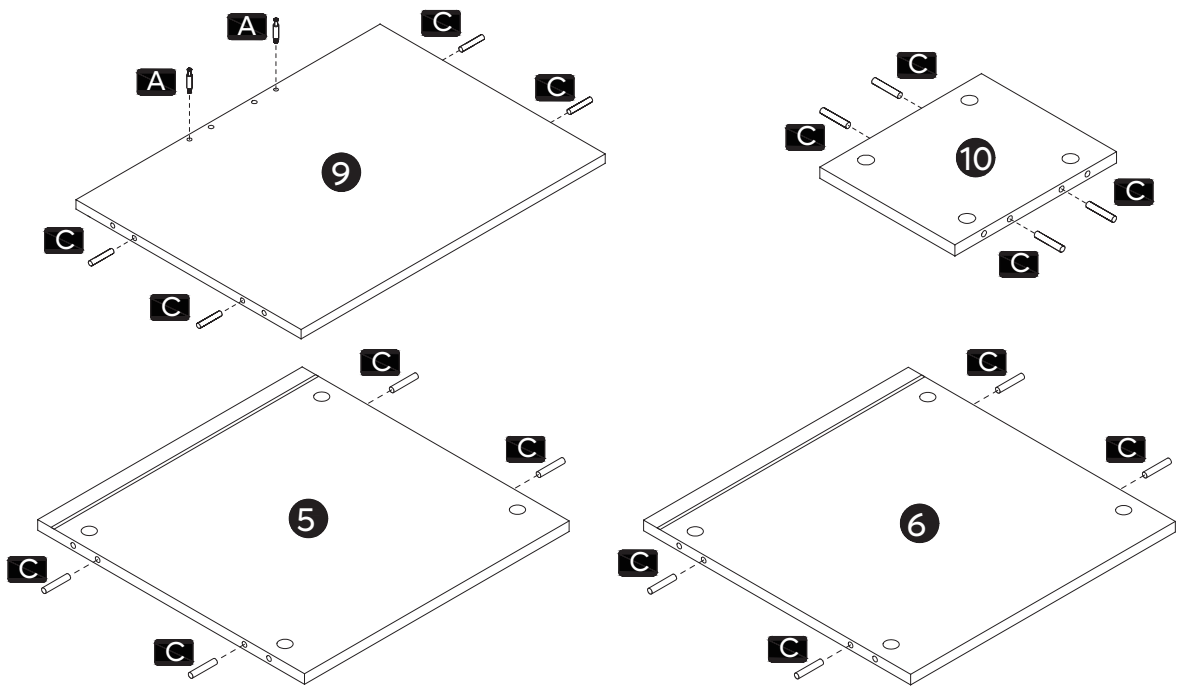

x 2

**A** Ø6x28mm



x 16

**C** ST6x30mm

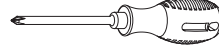

# 6

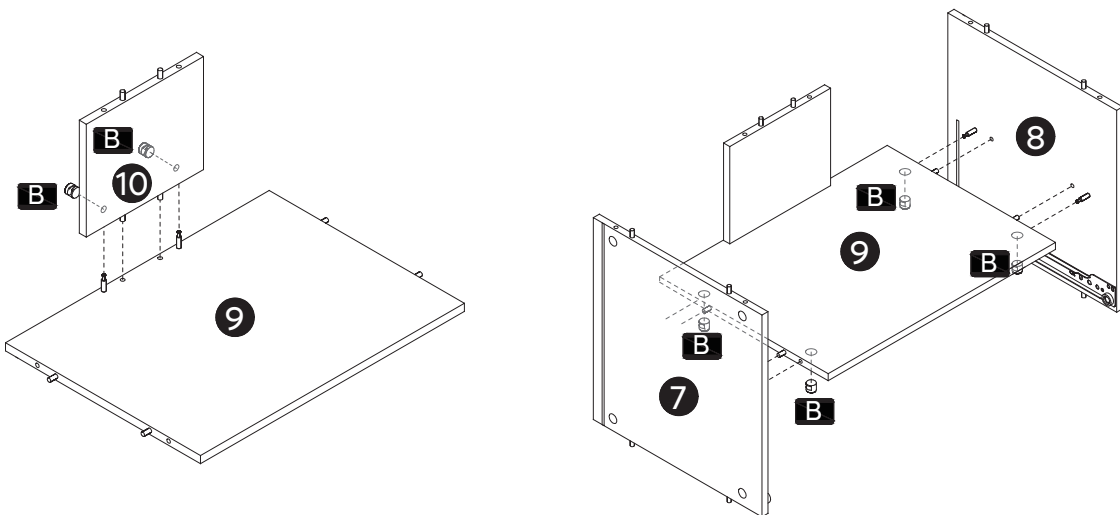

x 6

**B** Ø15x9.5mm

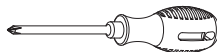

7

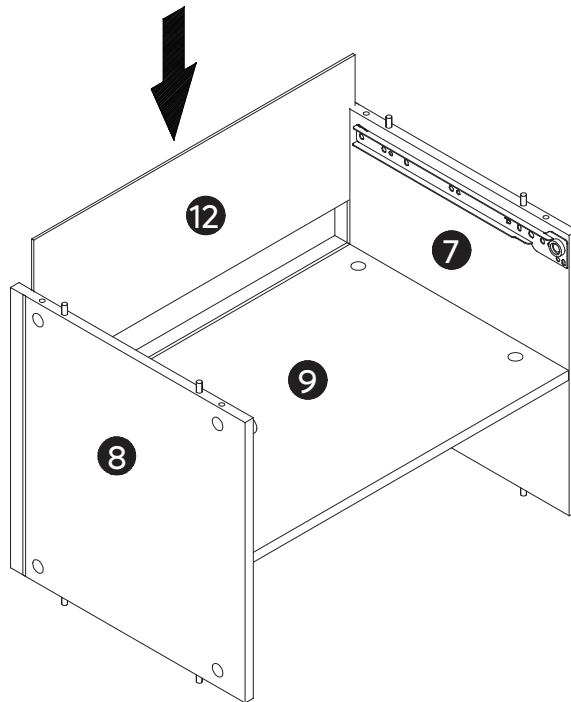

8

- The bottom back panel slot is in this direction.
- La fente inférieure du panneau arrière est dans cette direction.
- Der untere Schlitz auf der Rückseite befindet sich in dieser Richtung.
- La fessura inferiore del pannello posteriore è in questa direzione.
- La ranura inferior del panel trasero está en esta dirección.
- バックパネル下部のスロットはこの方向にあります。
- 底部背板槽在此方向。

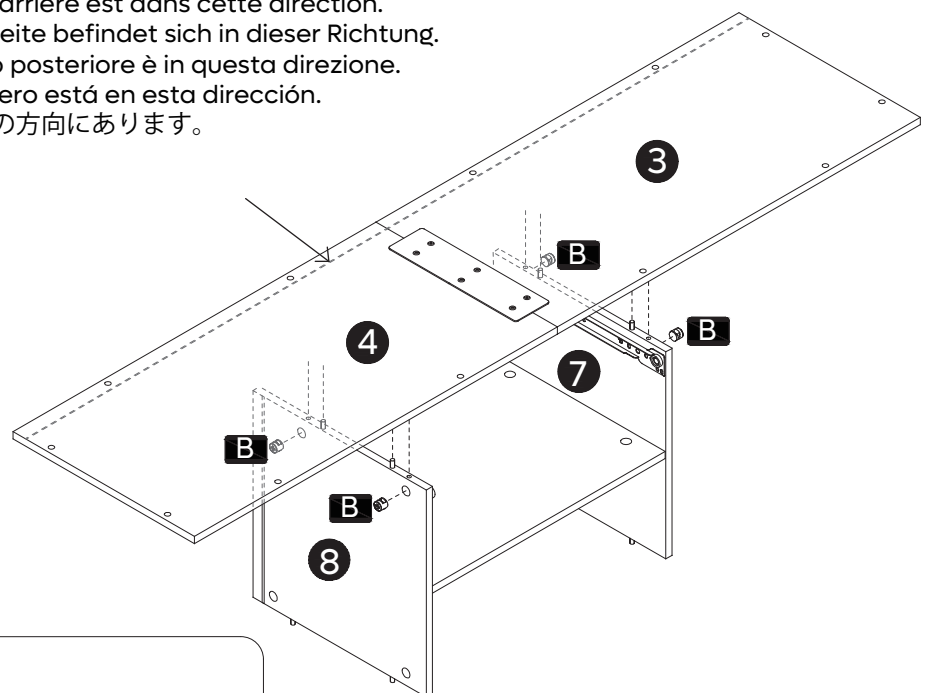

x 4

B Ø15x9.5mm

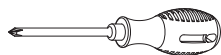

9

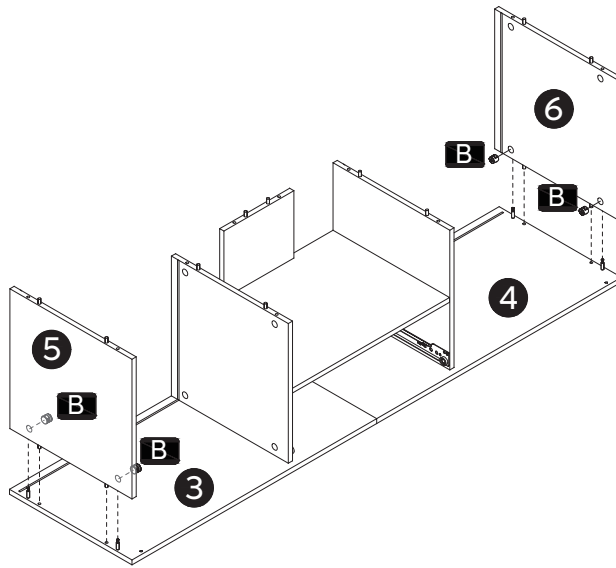

x 4

**B** Ø15x9.5mm

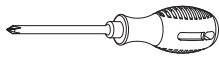

10

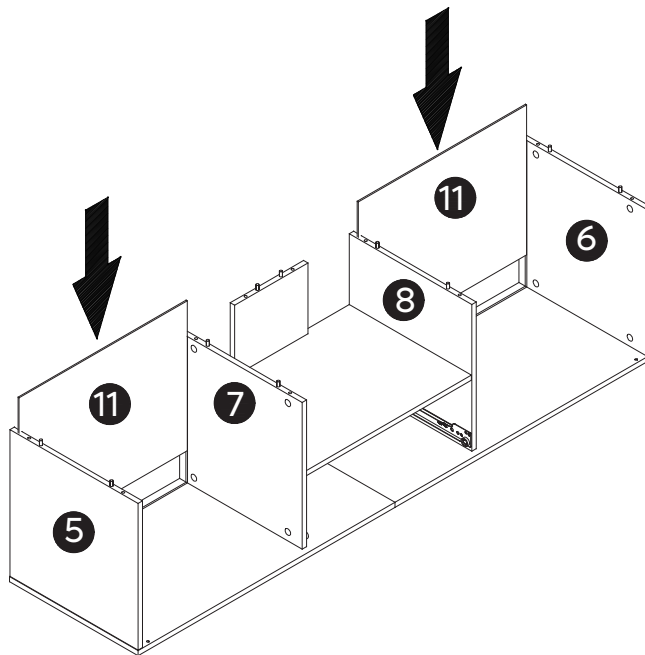

# 11

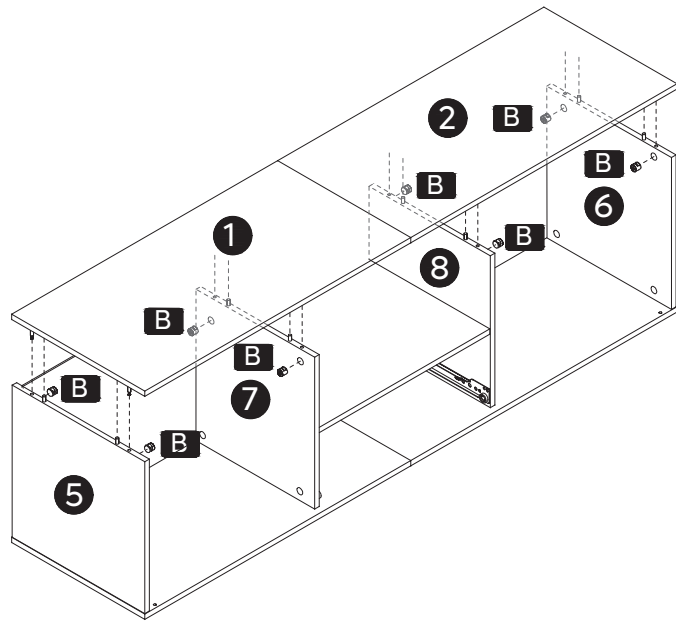

x 8

**B** Ø15x9.5mm

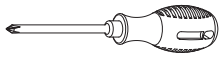

# 12

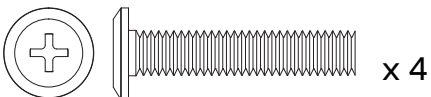
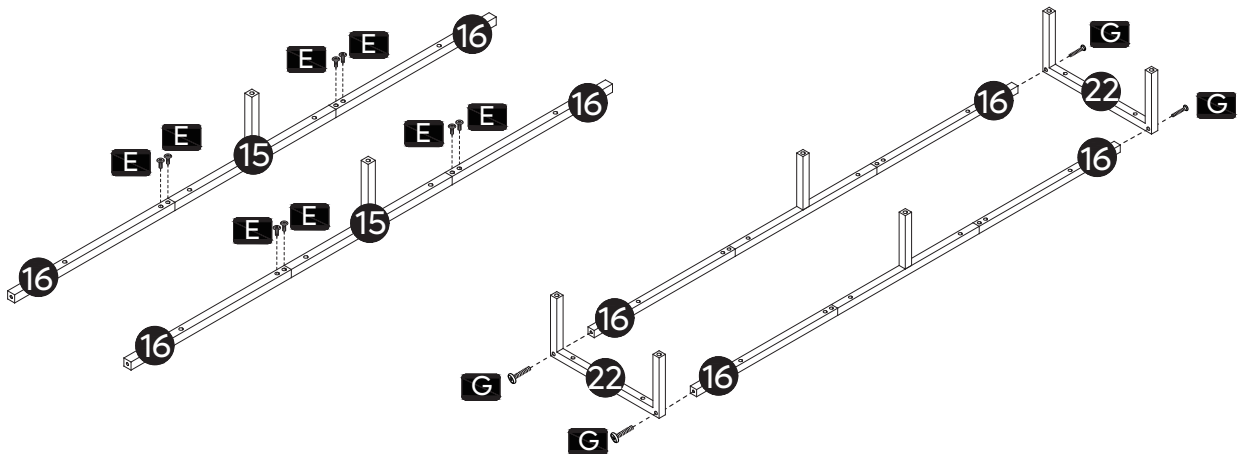

x 4

**G** M6x40mm

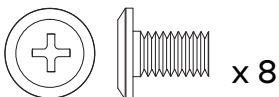

x 8

**E** M6x10mm

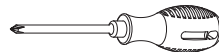

# 13

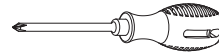
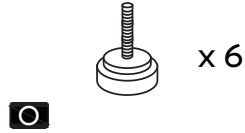
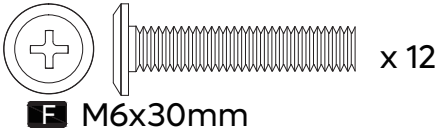
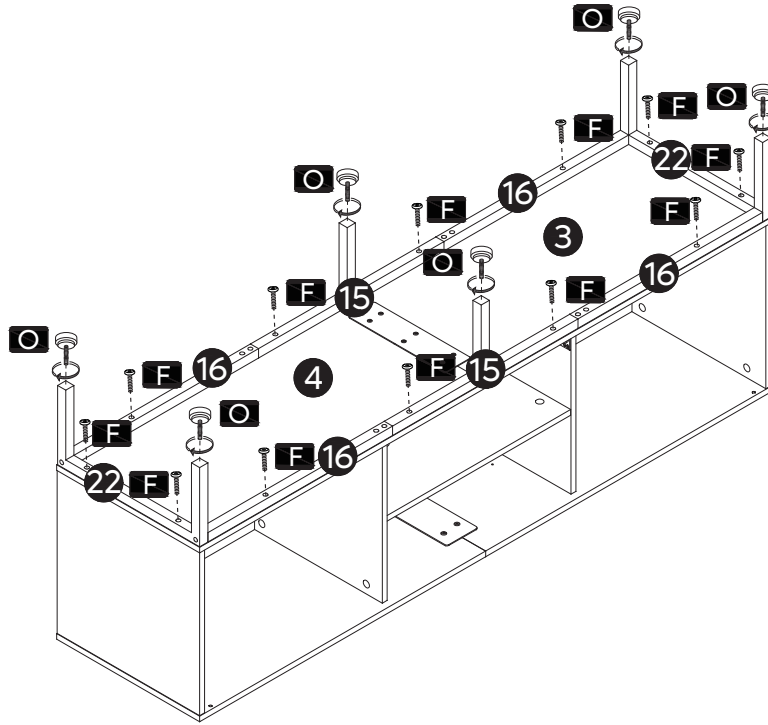

# 14

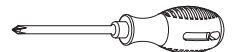
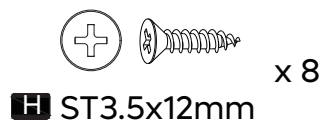
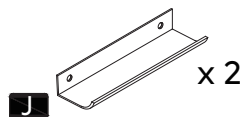
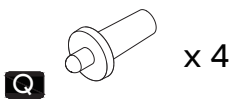
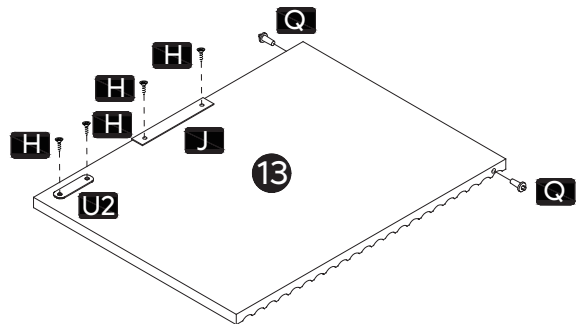
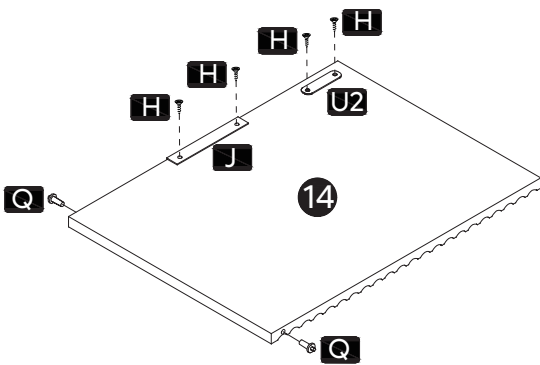

# 15

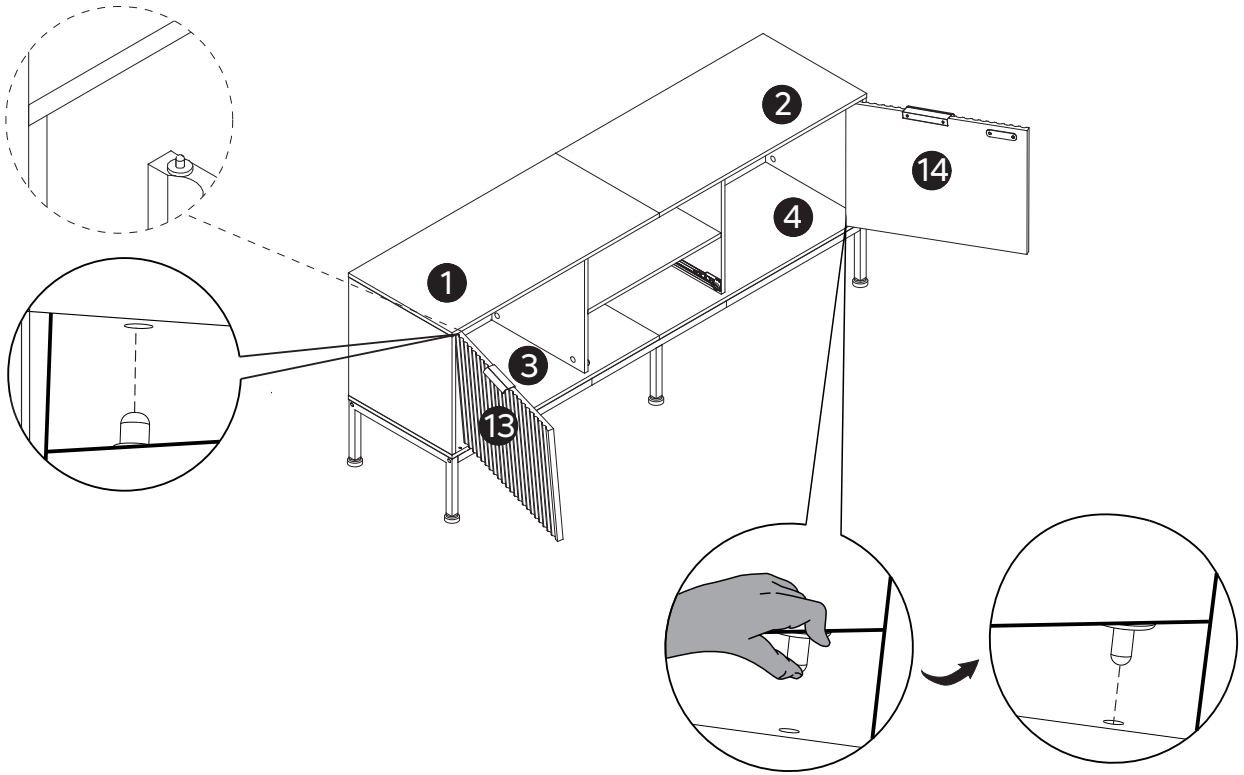

# 16

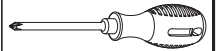
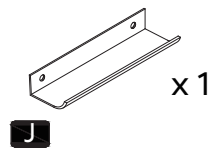
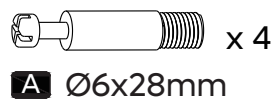
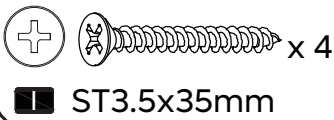
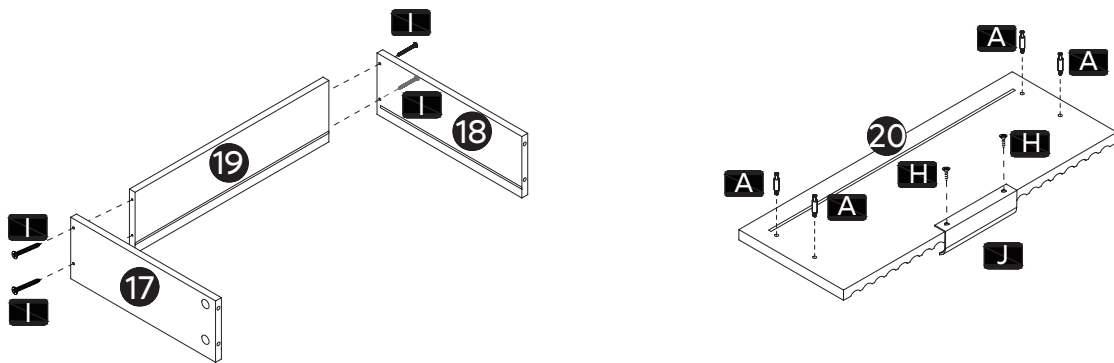

17

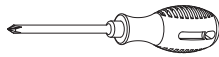
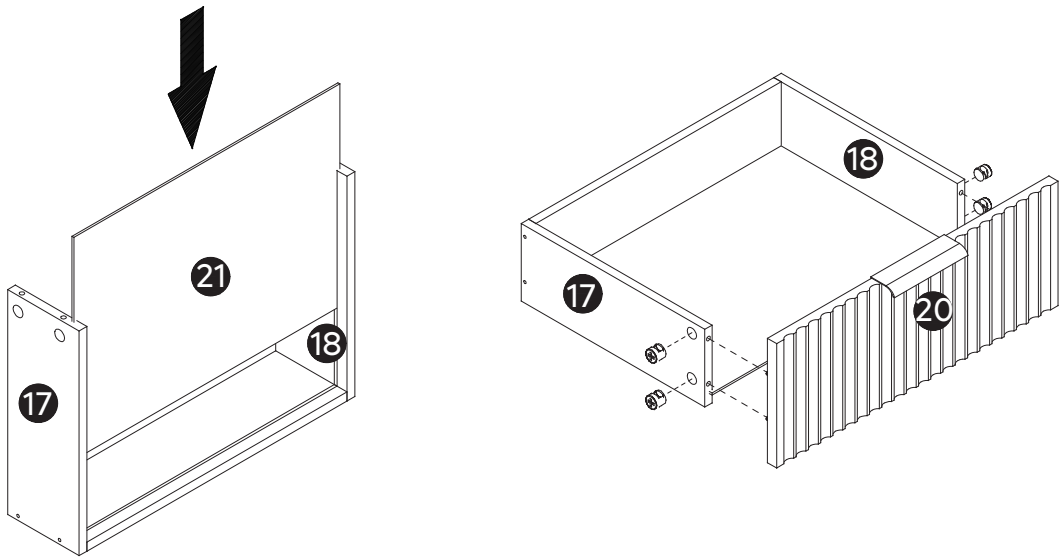

18

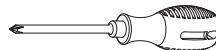
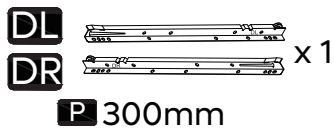
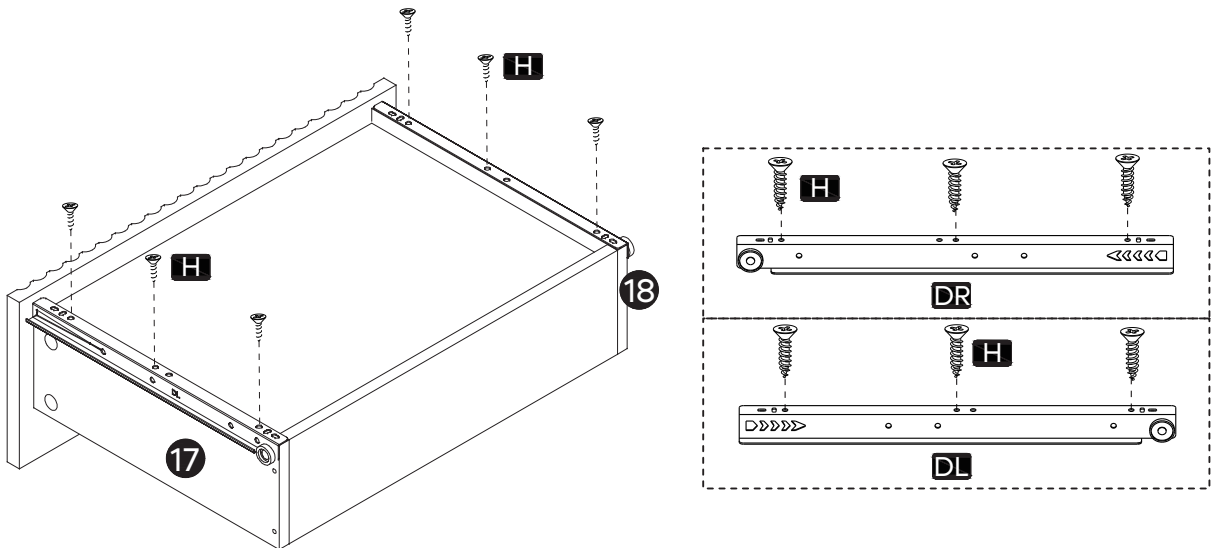

20

19

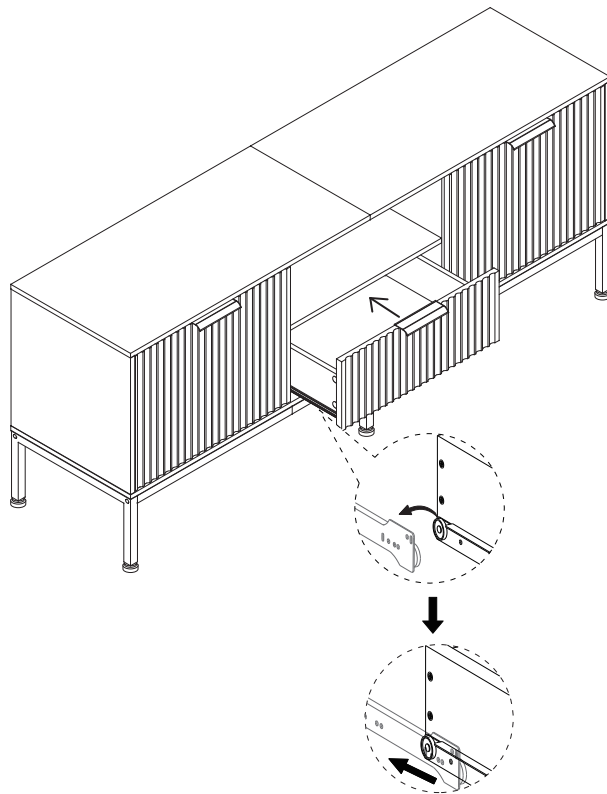

20

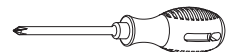
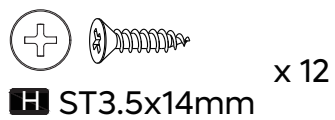
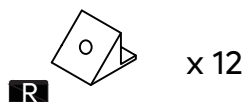
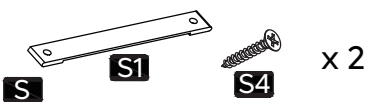
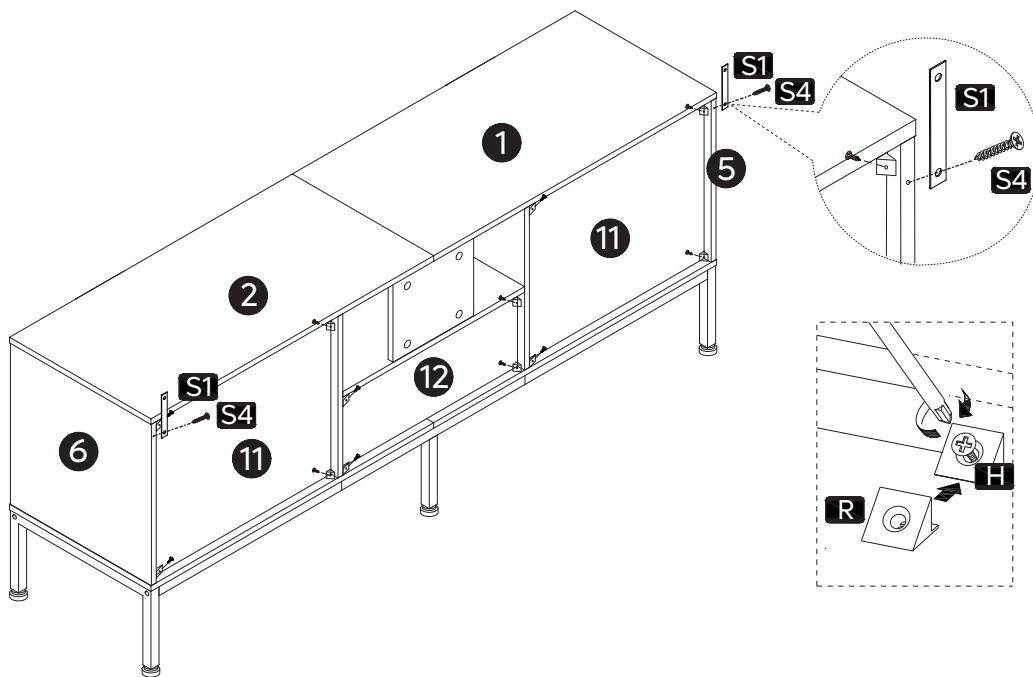

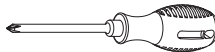
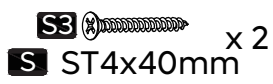
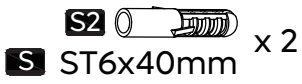
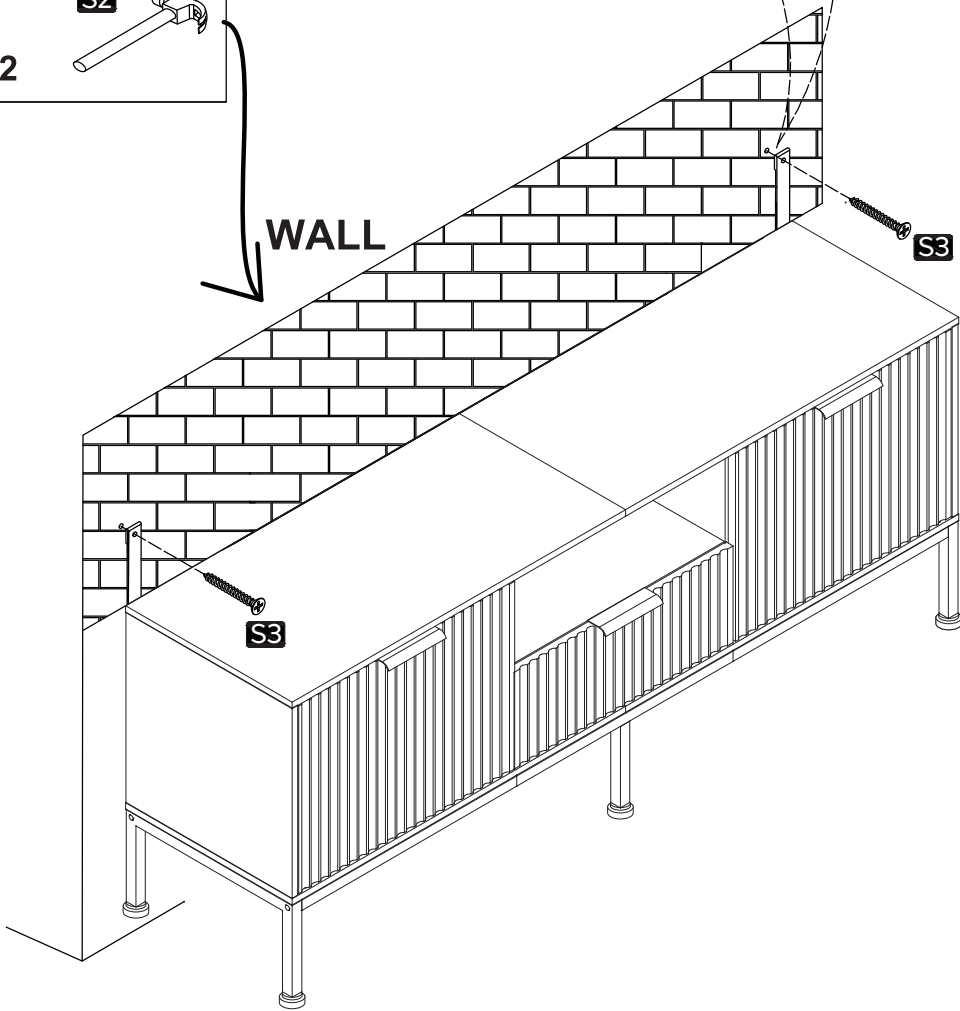
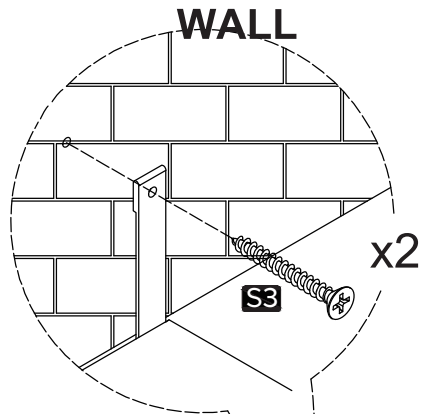
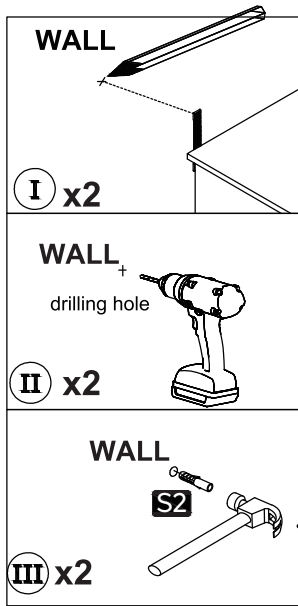

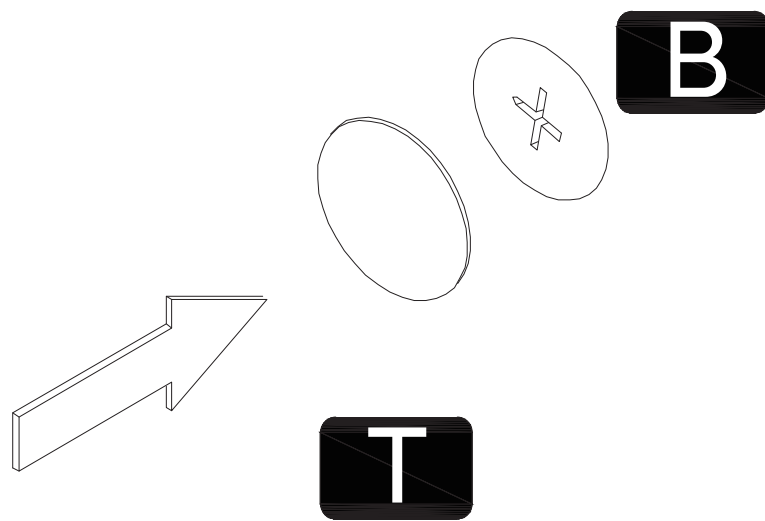

Hardware T is pasted on the hole of hardware B.  
Le matériel T est collé sur le trou du matériel B.  
Hardware T wird auf das Loch von Hardware B geklebt.  
L'hardware T è incollato sul foro dell'hardware B.  
El hardware T se pega en el orificio del hardware B.  
金具Bの穴に金具Tを貼り付けます。  
配件T粘貼在配件B的孔洞上

