

WARRANTY

We strive to offer high-quality products, and we also try our best to satisfy each and every customer that orders from us with product or service as needed. We provide 30 days warranty starting from the time you receive the item. Each customer must provide a record of their order such as the order number, or item receipt for any items that are out of the warranty period you may also still receive replacement parts by purchasing them with our company if they are available.



NOTE:

This brochure contains IMPORTANT safety info. Please read and keep for future reference.

MAINTAINANCE AND WARNING





- Keep furniture away from heat sources.
- Do not clean furniture with harsh cleaner or polishes. Do not use detergents, Solvents, abrasives, spray packs or leather cleaner. Use non-color mild soap with warm water to clean spills(Mix 1:10 soap to water)
- Do not place furniture under direct sunlight, material will possibly fade over time.
- Do not use on site dry Cleaning machine.
- Children should not climb or jump on the furniture.
- Do not write on furniture that is not protected by a padded barrier .
- Not for commercial use, only for residential use.



Weight Limitation

250LBS

PARTS LIST

No.	Parts	Quantity
1		1
2		1
3		2
4		2





Persons Required For Assembly:

1Personen



ASSEMBLY INSTRUCTIONS

1. Remove all parts from the carton and place them on a protected surface or carpet. Take out the wood legs (3 & 4) out of the seat box.

No.	Parts	Quantity
1		1
2		1
3		2
4		2

2. Attach the wood legs (3 & 4) to the corners of the seat cushion (1) as shown.

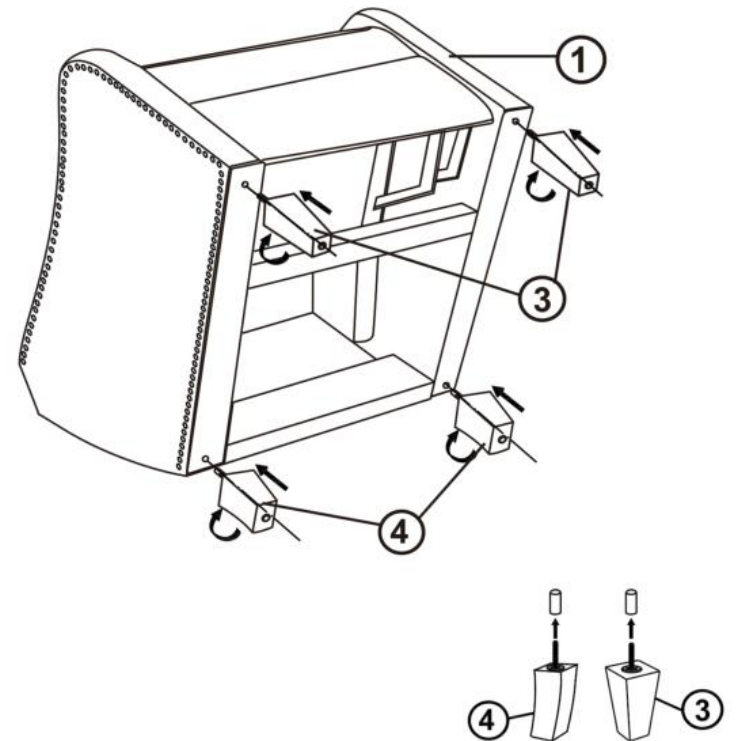

3. Attach the back cushion (2) to the seat cushion (1) by sliding the receivers into the mechanism posts located on the seat cushion (1). From the back of the recliner, press down on both sides of the back cushion (2) to firmly secure. The back cushion (2) and seat cushion (1) will automatically lock into place. Then pull the back flap down tightly and attach the back flap to the bottom of the seat cushion (1).

