

# Assembly Instructions

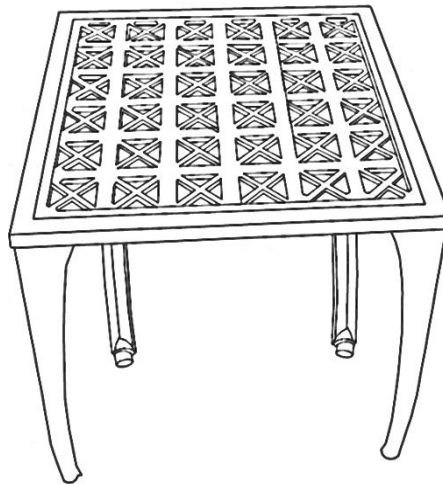

**Caution : You must read this before you proceed**

## End Table





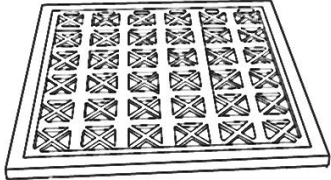



**CAUTION** : This table is NOT a TOY.  
Keep your child / children at bay during the assembly process.

## Parts List

Label	Picture	Description	QTY
A		Table Top	1
B		Table Leg with pre-attached Levellers	4

# Hardware

Label	Picture	Description	QTY
①		Bolt(M8*30mm)	5
②		Washer(8mm)	5
③		Spring Washer(8mm)	5
④		Nut(8mm)	5
⑥		Spanner	1
⑦		Screwdriver	1
⑧		Rubber Cap	5

## Assembly Preparation

Before Beginning Assembly:

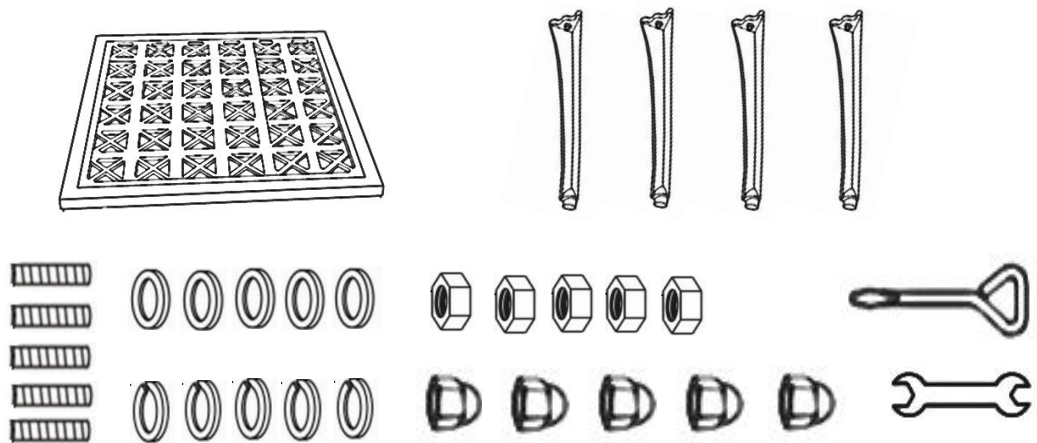

- Read instructions, cover to cover-



- Have 2 adults on hand for assembly-



- Do not assemble on flooring or carpet-



- Assemble on a clean non-marring surface (packing foam)-



- Save all packaging until finished-

# Assembly Steps

## Overview

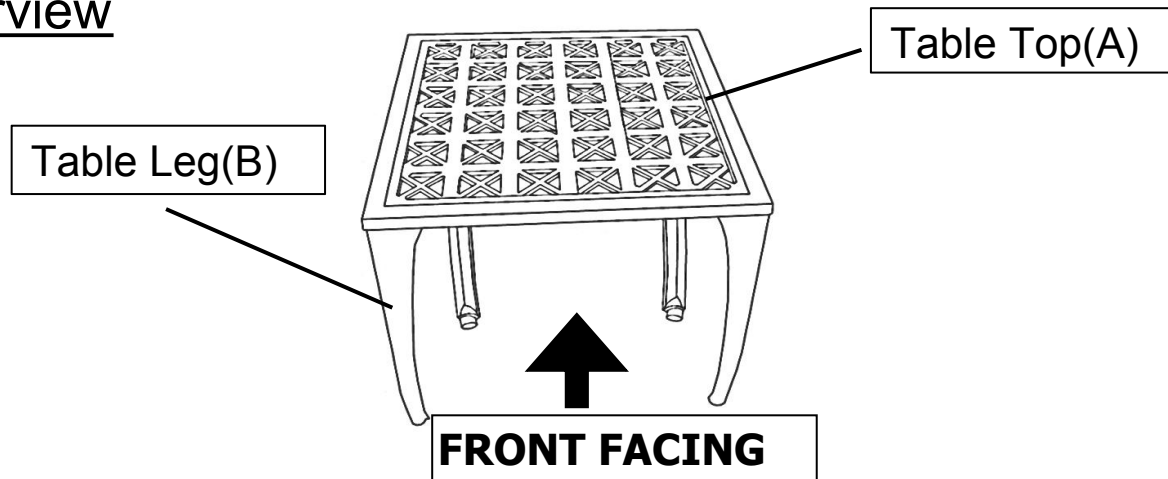

This Table has multiple parts and may require up to some 30 minutes to assemble.

To give you an overview of the Table parts, the above picture is to help you put the various parts into perspective.

Please read through the instructions below to familiarise yourself with the parts and steps before assembly.

## Step 1

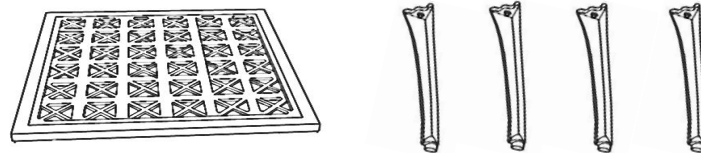

Unpack and place all parts on a clean, soft surface.

## Step 2

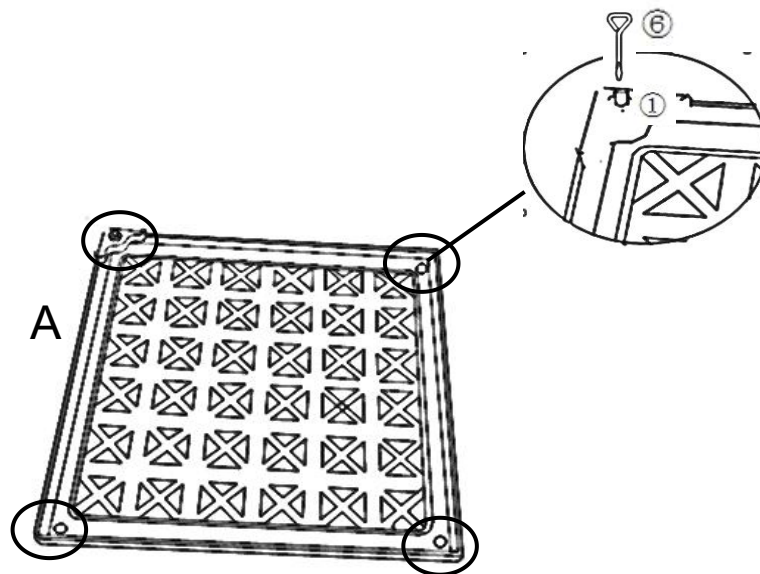

Lay the Table Top(A), facedown, onto a flat, soft, clean surface and lock the mounting positions with bolts(1) by using Screwdriver(6).

Repeat the same process for the mounting positions of the Table Top.

**Need tighten the bolts.**

### Step 3

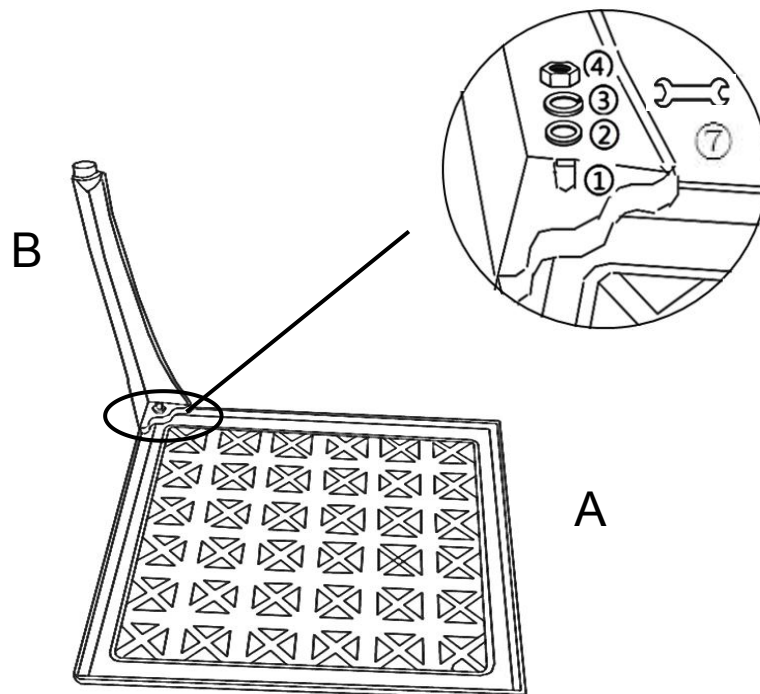

Attach the Table Leg with pre-attached Levellers(B) to the Table Top(A) using Washers(②), Spring Washers(③), and nuts(④) with spanner(⑦).  
**DO NOT OVERTIGHTEN.**

### Step 4

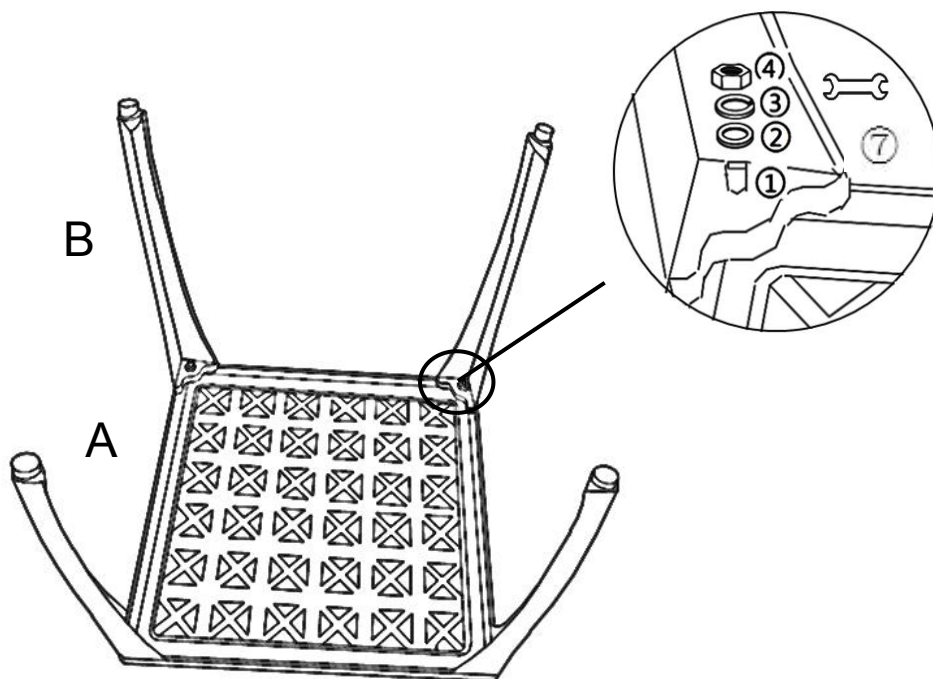

Repeat step 3, attaching the remaining 3 table legs to the Table top(A).  
**At this stage, only loosely tighten the Bolts.**

## Step 5

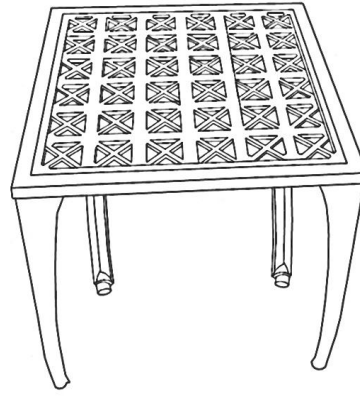

Stand the table right side up.

Tighten the Levellers.

Inspect it and make sure all parts are adequately connected.

Now, fully and securely, tighten all nuts, at all joints.

**When tightening the Bolts, tighten sequentially.**

**DO NOT tighten any Bolt fully and then move on to the next one.**

**If there is still wobbles, loosen the bolts and execute this same process.**

**If the Table is not stable it could lead to damage to the product.**

## Step 6

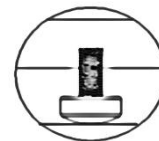
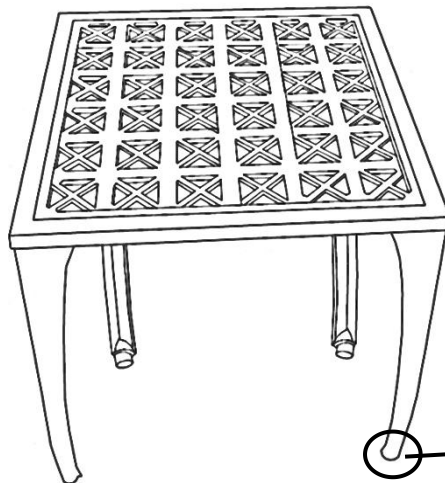

Adjust height  
for balance

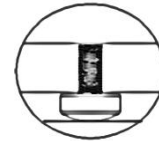

Adjust low  
for balance









Adjust Pre-installed  
Levellers  
height for balance

Adjust the Legs pre-installed Levellers until the Table is level with the ground.

Add Rubber Caps(Ⓢ) on all bolt ends to protect skin or clothing from getting snagged.

**Caution: This TABLE can only be used on a flat, level surface.**

## Care & Maintenance

-  Do not put hot items directly on furniture surface.
  -  Do not clean furniture with harsh cleansers or polish.
  -  To obtain the longest lifespan of your outdoor products, minimizing exposure to direct sunlight is recommended.
  -  Children should not climb or jump on the furniture.
  -  Do not write on furniture without a padded barrier to protect the surface.
  -  To obtain the longest lifespan of your outdoor products, avoid extended and lengthy exposure to rain, snow, and direct sunshine. Whenever possible cover the product and /or place under patio or awnings.
  -  Not for commercial use. For residential use only .
  -  Stains may be removed with mild soap solution and damp cloth.
- 
-  Dust and pick-up spills using a clean, non-colored, lint-free cloth .