

Installation Instruction

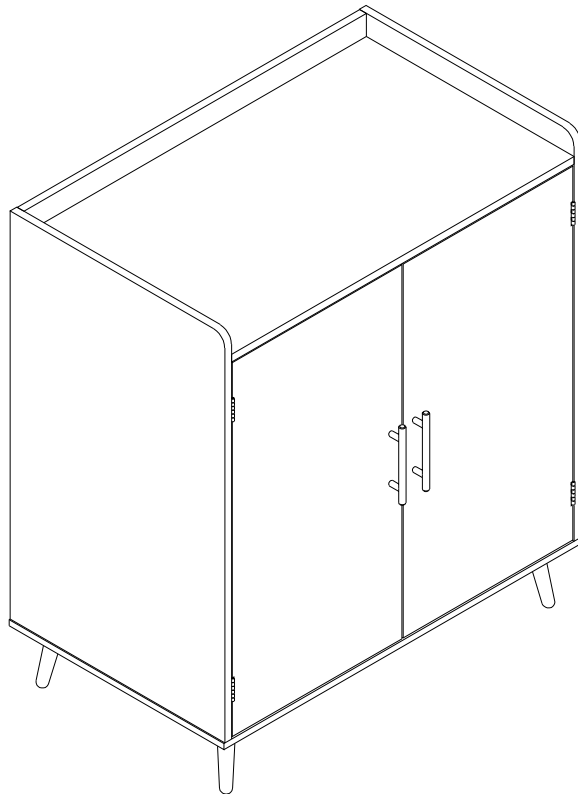

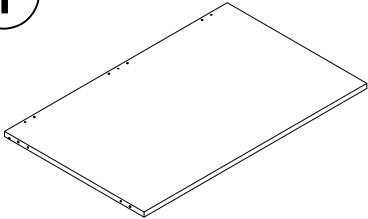

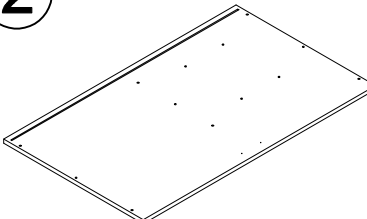

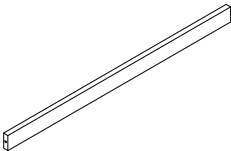
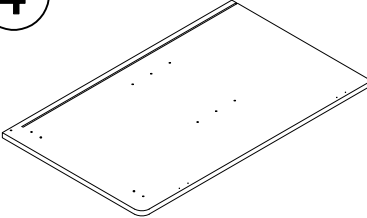
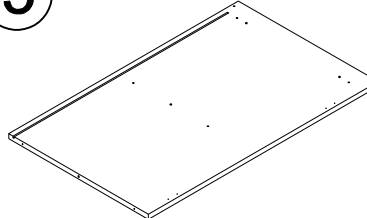
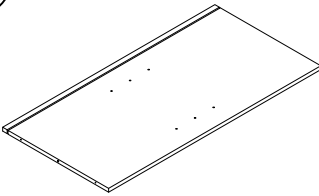
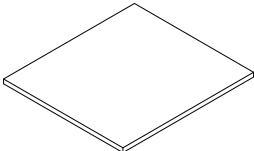
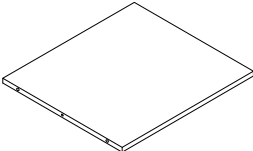
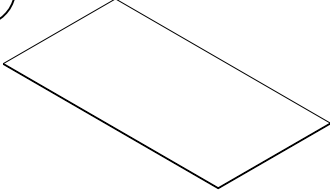
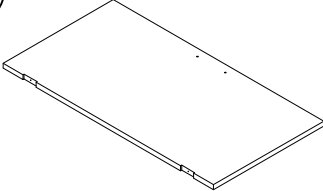
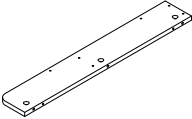
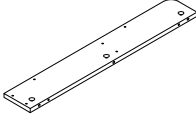
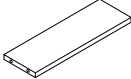
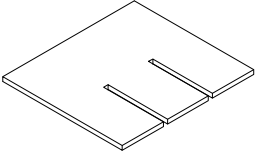
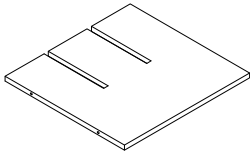



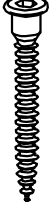







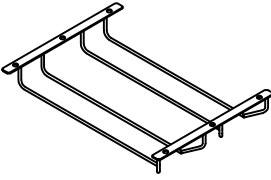
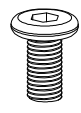

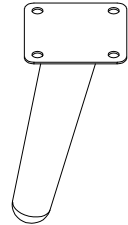
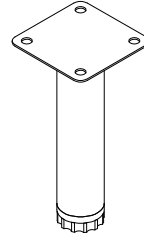
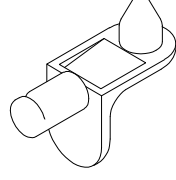
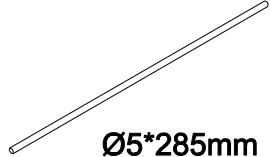

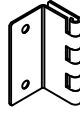
Please don't tighten the screws completely and go back later for a final tightening of all the screws after pieces are aligned with each other.

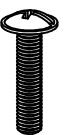
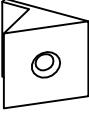

HARDWARE LIST

<p>①</p>  <p>1PCS</p>	<p>②</p>  <p>1PCS</p>	<p>③</p>  <p>1PCS</p>
<p>④</p>  <p>1PCS</p>	<p>⑤</p>  <p>1PCS</p>	<p>⑥</p>  <p>1PCS</p>
<p>⑦</p>  <p>1PCS</p>	<p>⑧</p>  <p>1PCS</p>	<p>⑨</p>  <p>2PCS</p>
<p>⑩</p>  <p>2PCS</p>	<p>⑪</p>  <p>2PCS</p>	<p>⑫</p>  <p>2PCS</p>
<p>⑬</p>  <p>4PCS</p>	<p>⑭</p>  <p>2PCS</p>	<p>⑮</p>  <p>2PCS</p>

PARTA LIST

<p>A</p>  <p>M5*45mm</p> <p>6PCS</p>	<p>B</p>  <p>Ø6*32mm</p> <p>43+2PCS</p>	<p>C</p>  <p>43+2PCS</p>	<p>D</p>  <p>Ø6*30mm</p> <p>30+2PCS</p>
<p>E</p>  <p>Ø3.5*12mm</p> <p>4PCS</p>	<p>F1  2PCS</p> <p>F2  4PCS</p> <p>F3  M3*14mm 4PCS</p>	<p>G</p>  <p>320*235*42mm</p> <p>1PCS</p>	<p>H</p>  <p>M6*10mm</p> <p>6PCS</p>
<p>I</p>  <p>Ø4*12mm</p> <p>20+2PCS</p>	<p>J</p>  <p>54x54x120mm</p> <p>4PCS</p>	<p>K</p>  <p>54x54x115mm</p> <p>1PCS</p>	<p>L</p>  <p>4PCS</p>
<p>M</p>  <p>Ø5*285mm</p> <p>4PCS</p>	<p>N</p>  <p>Ø3*12mm</p> <p>20+2PCS</p>	<p>O</p>  <p>4PCS</p>	<p>P</p>  <p>Ø10*150*35mm</p> <p>2PCS</p>
<p>Q</p>  <p>M4*20mm</p> <p>4PCS</p>	<p>R1  12+1PCS</p> <p>R2  Ø3*16mm 12+1PCS</p>	<p>S1  2PCS</p> <p>S2  M4*12mm 2PCS</p> <p>S3  M4*35mm 2PCS</p> <p>S4  2PCS</p>	<p>M4  1PCS</p> <p> 1PCS</p>

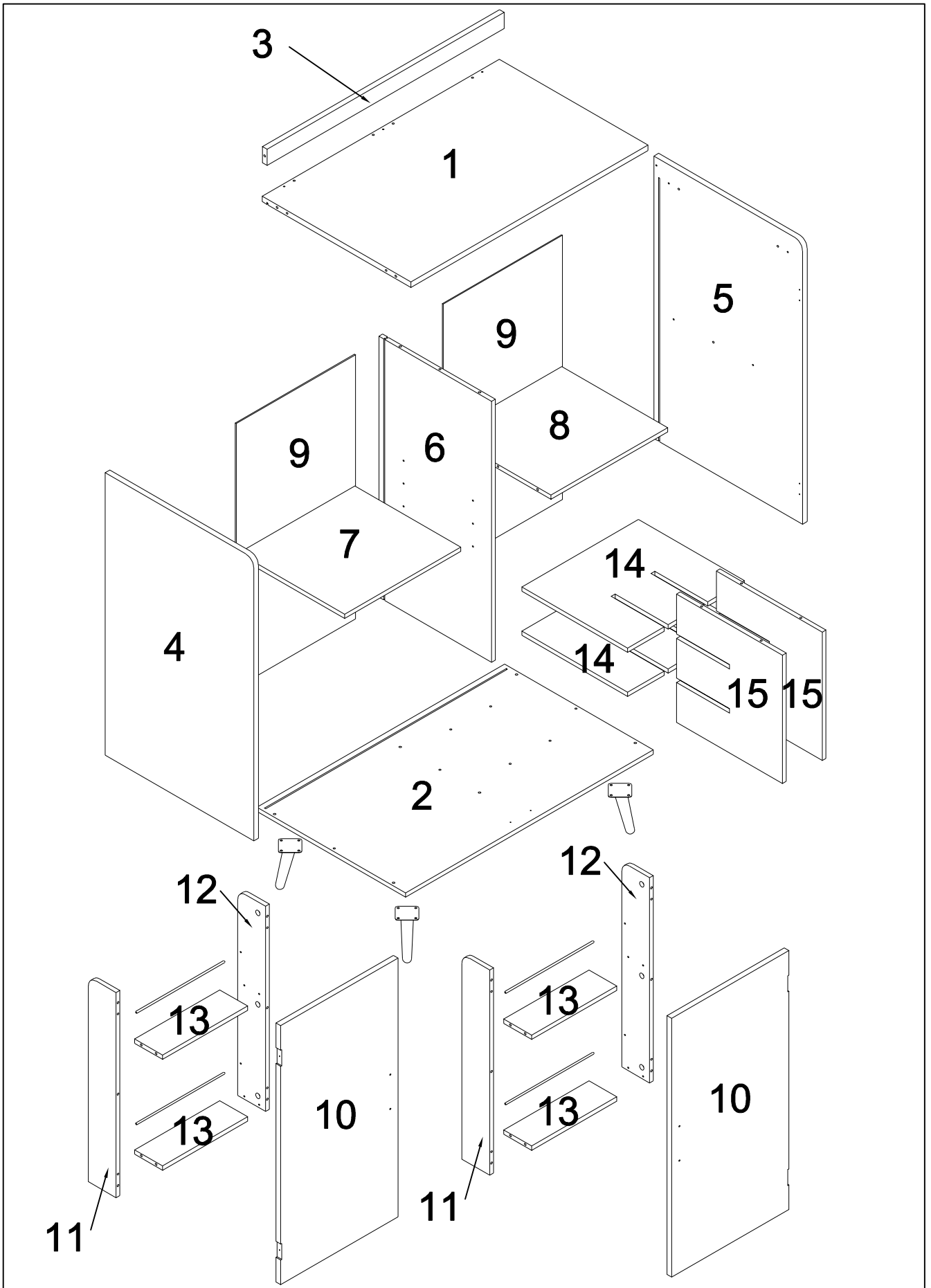

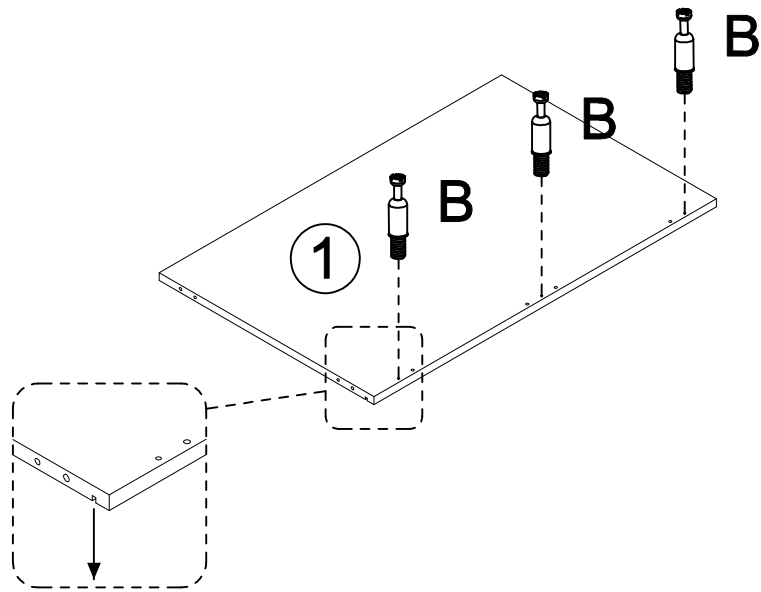
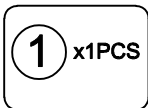

1

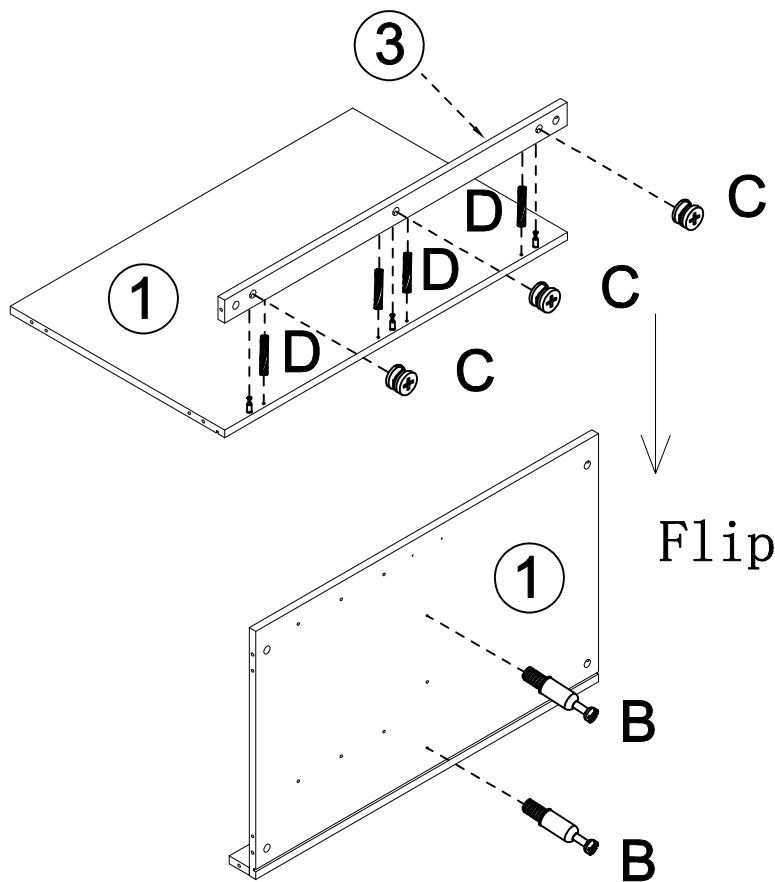
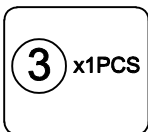
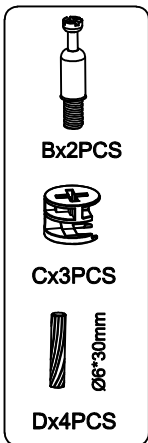

2



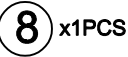

3

-  Bx2PCS
-  Cx2PCS
-  Dx1PCS

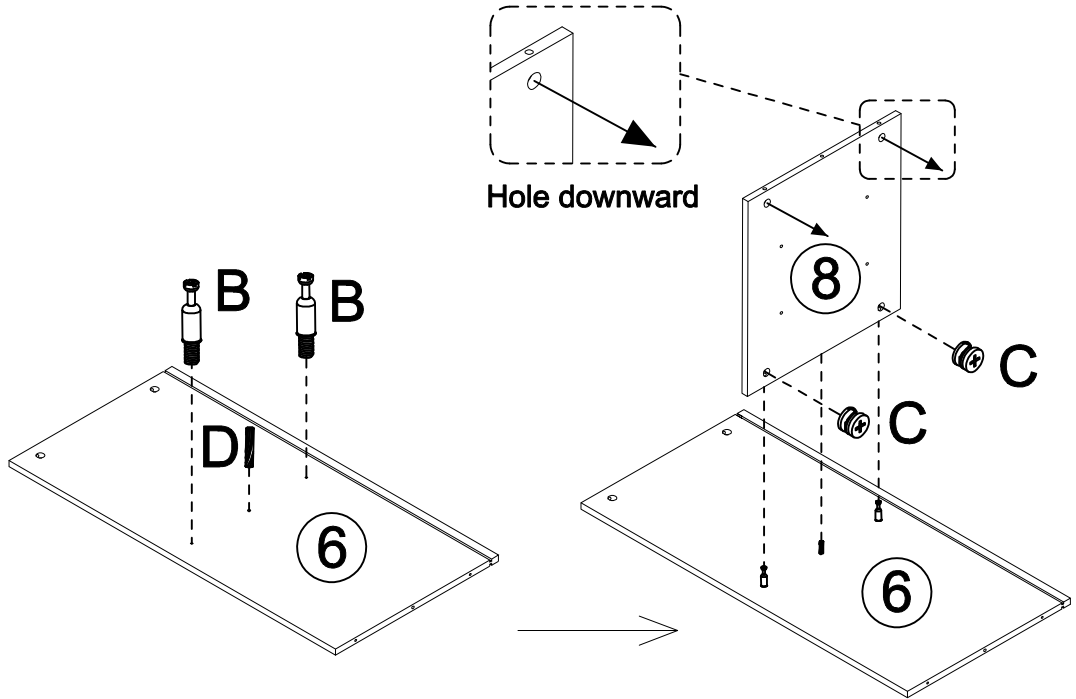
-  6 x1PCS
-  8 x1PCS



4

-  Cx2PCS
-  Dx1PCS

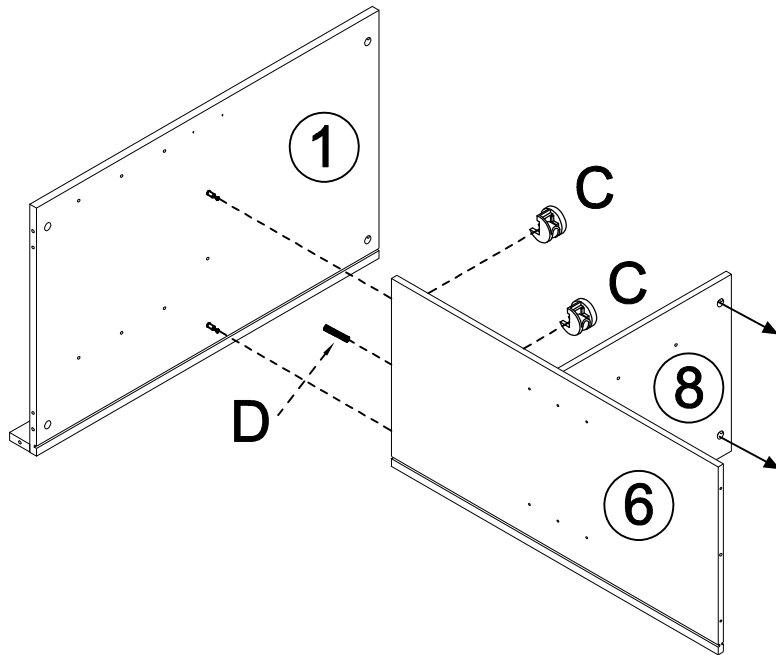

5

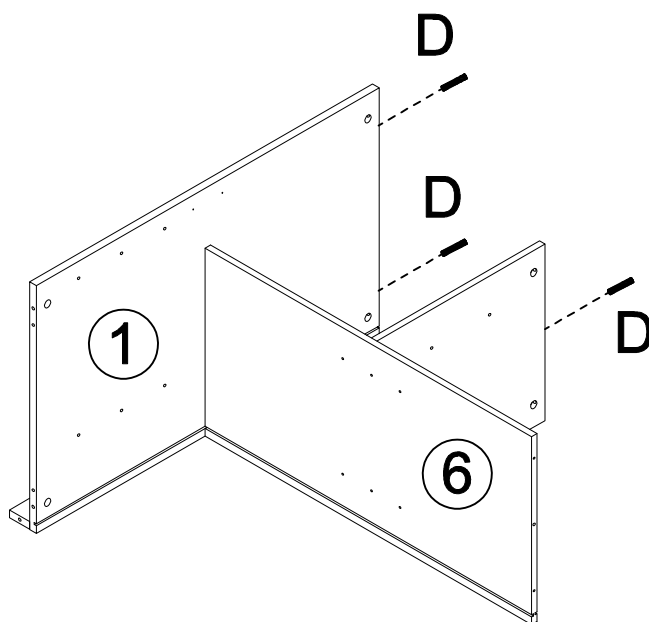
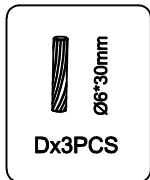

6

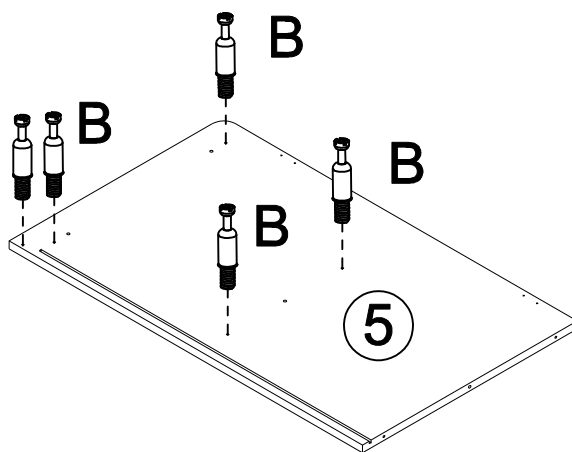
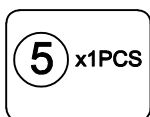

7

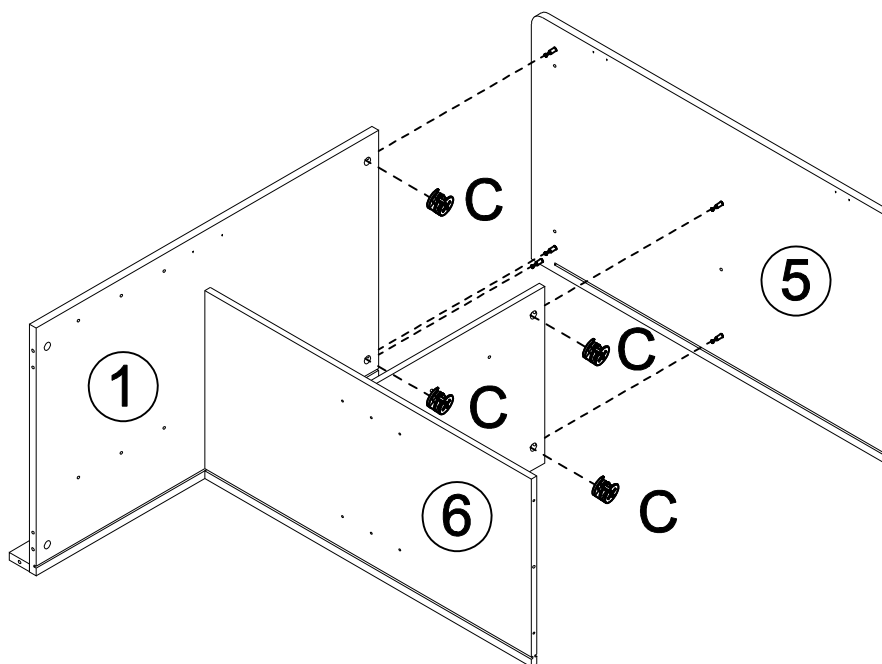

8

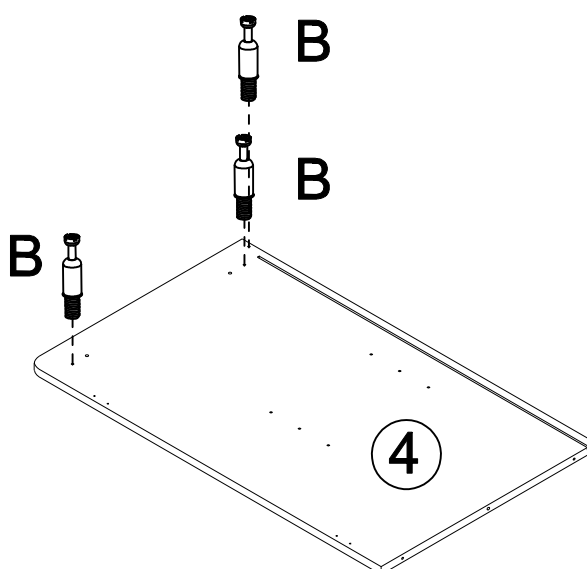
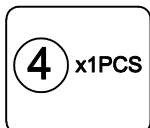

9

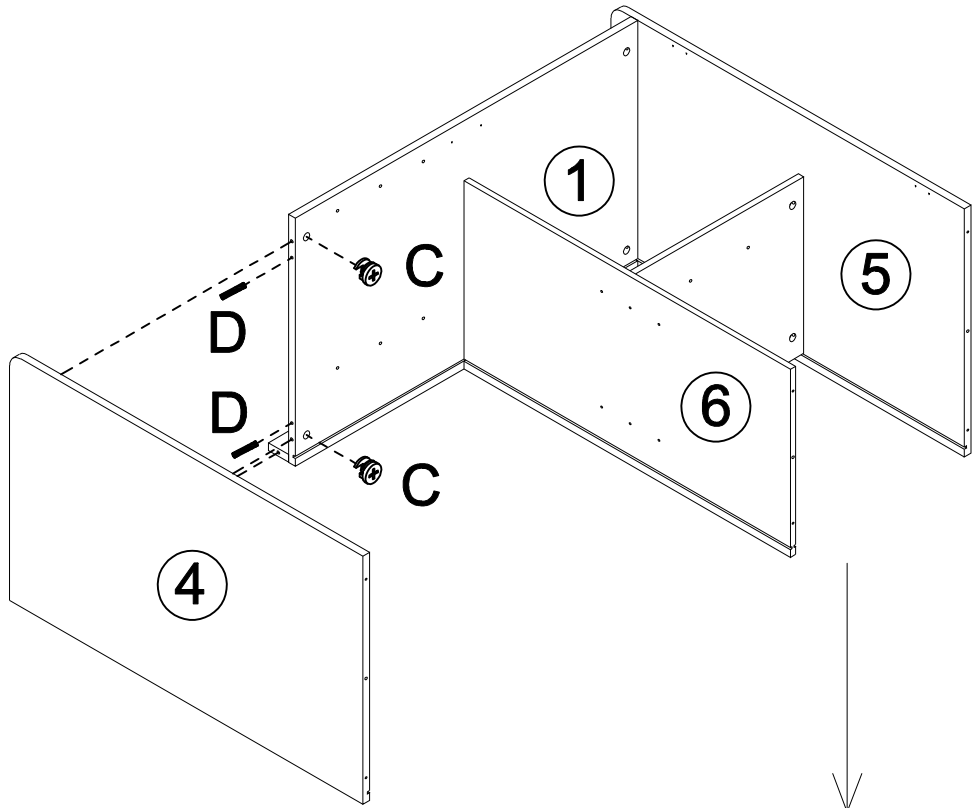
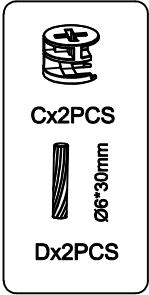

10



Rotate 90 degrees

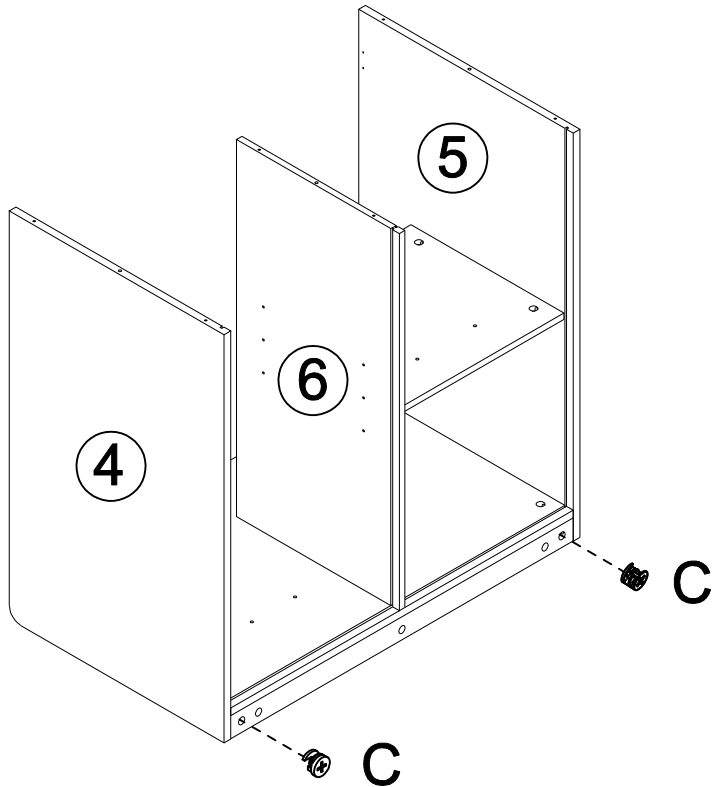

11

9 x2PCS

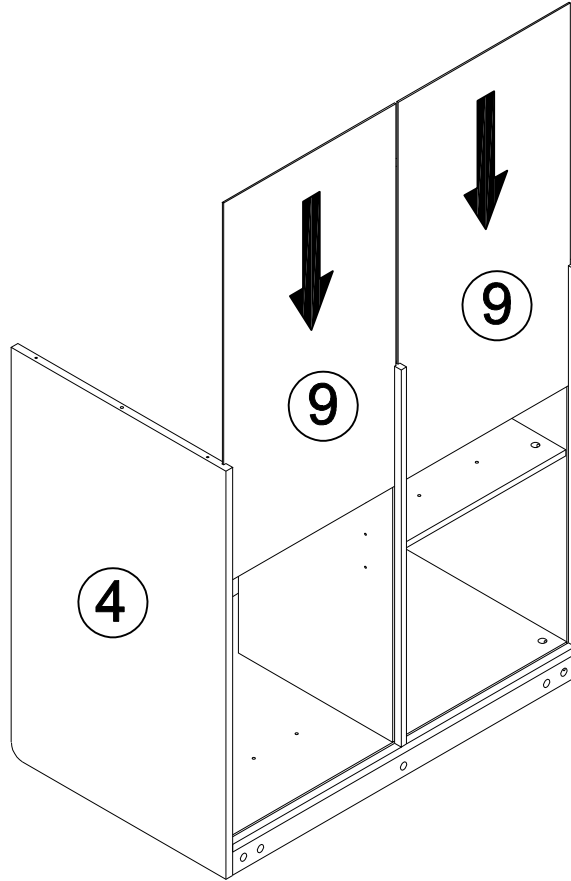

12

14 x2PCS
15 x2PCS

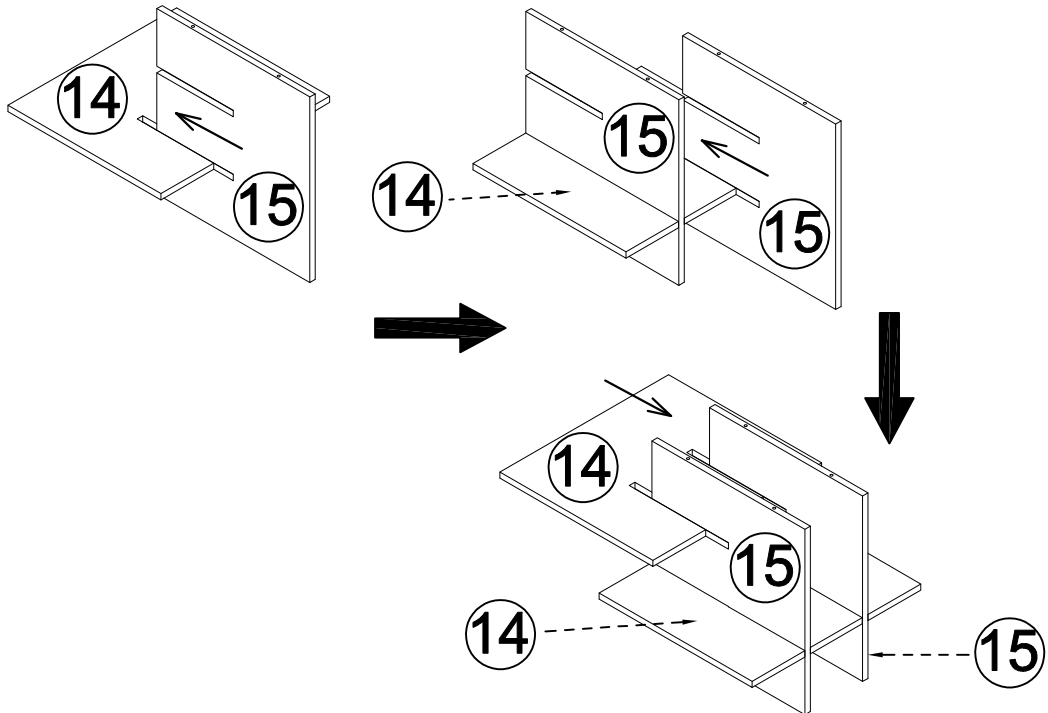

13

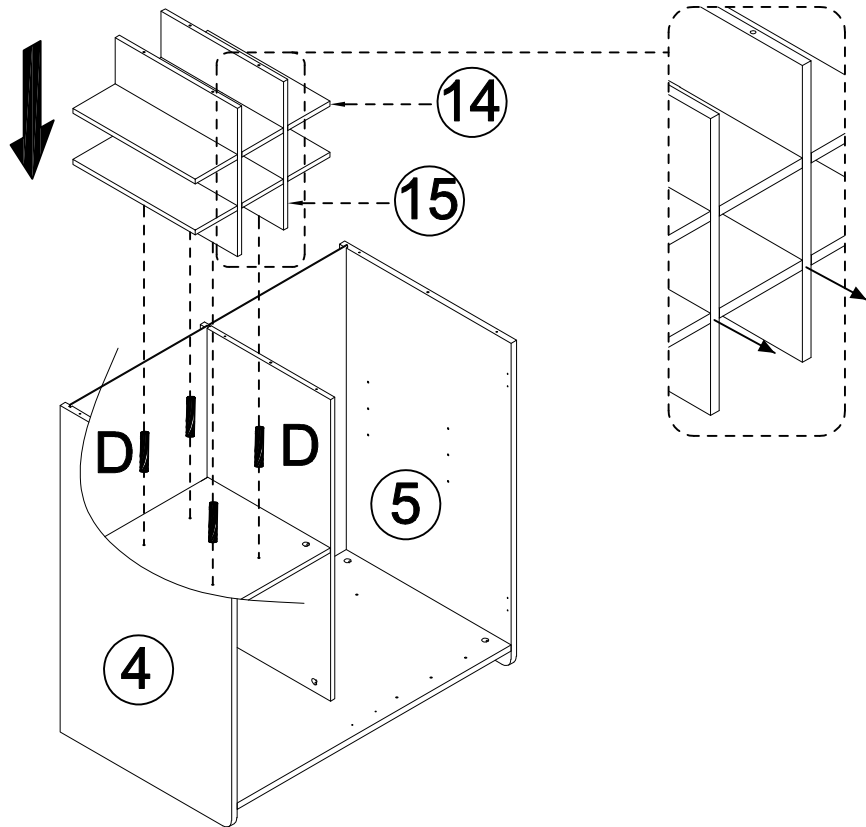
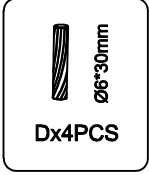

14

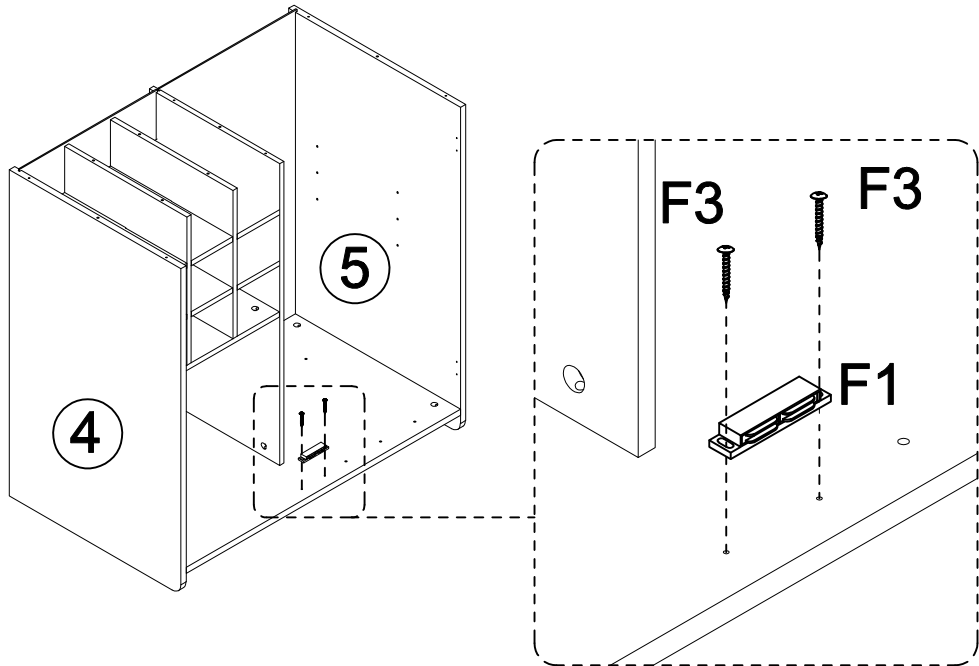
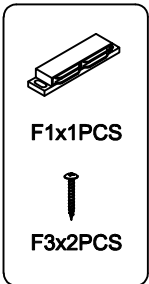

15

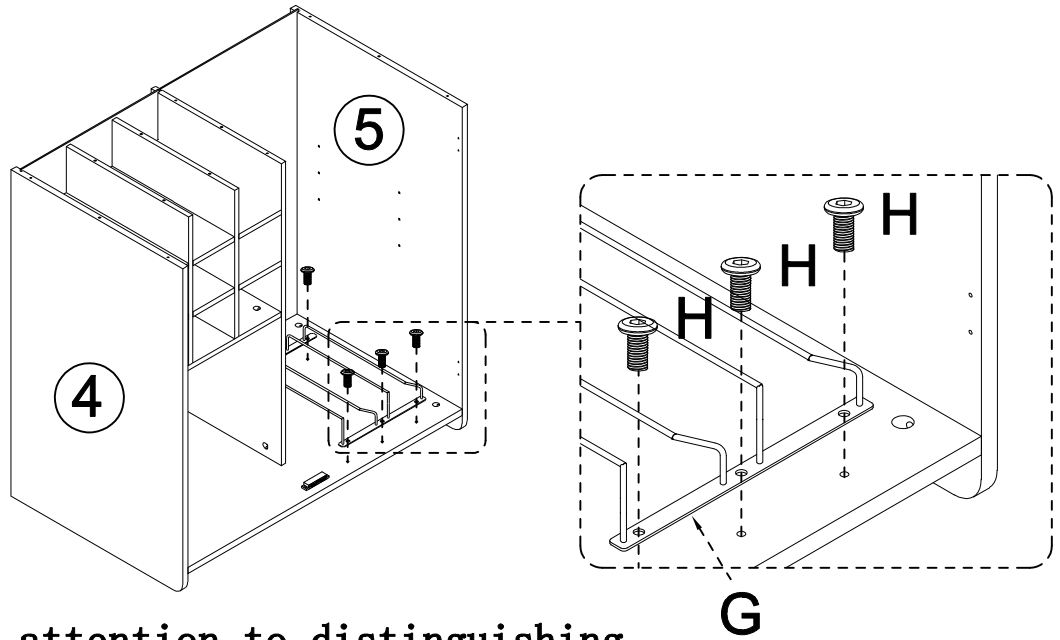
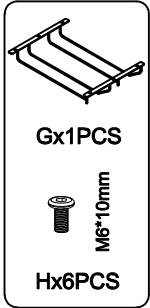

Pay attention to distinguishing the front and back of the wine glass rack

16

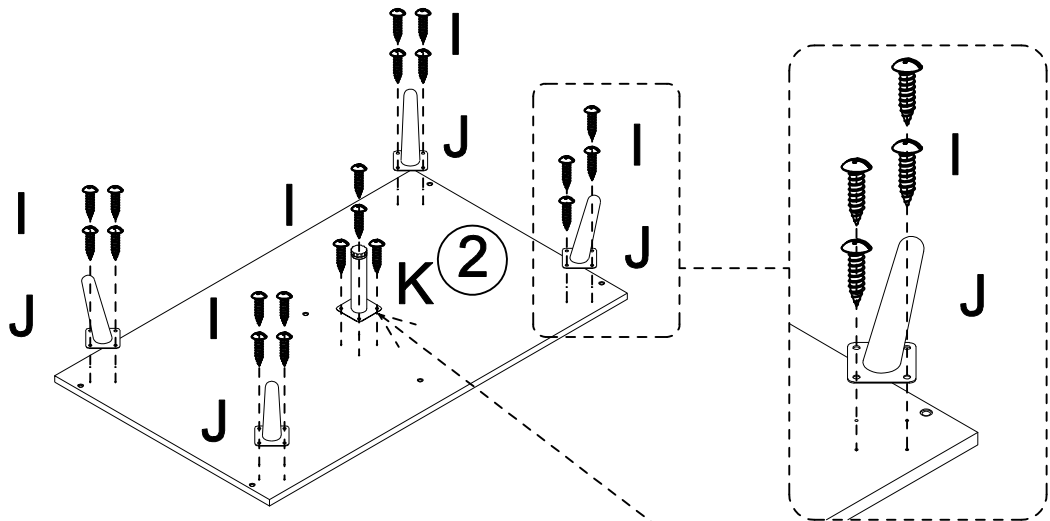
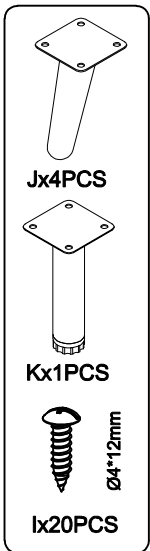

Foot installation according to the plane direction

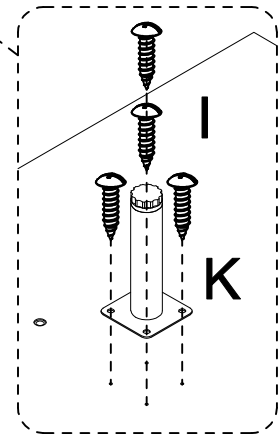
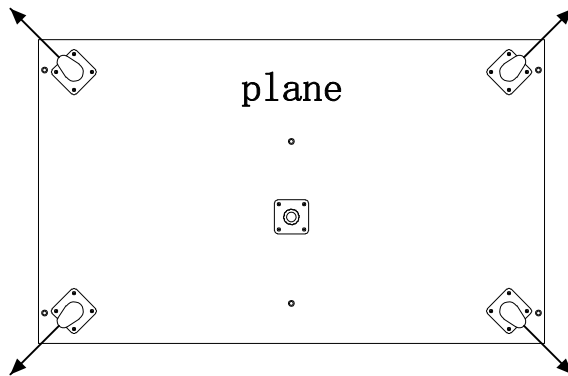

17

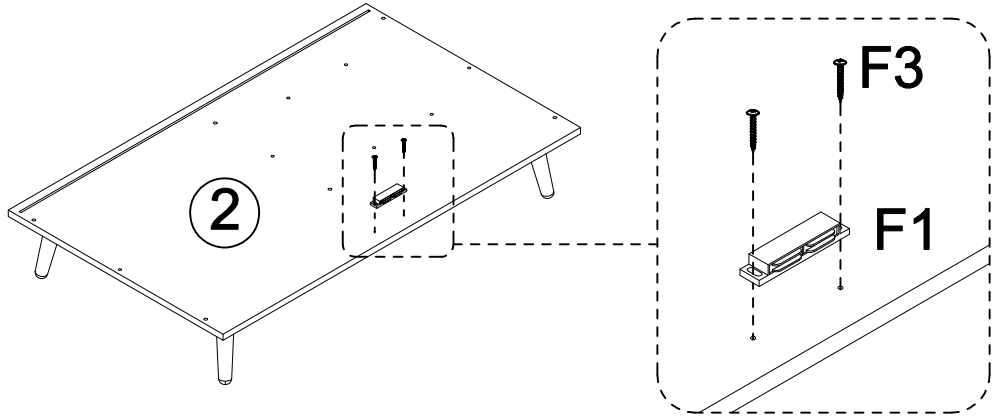
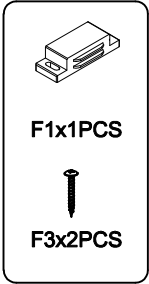

18

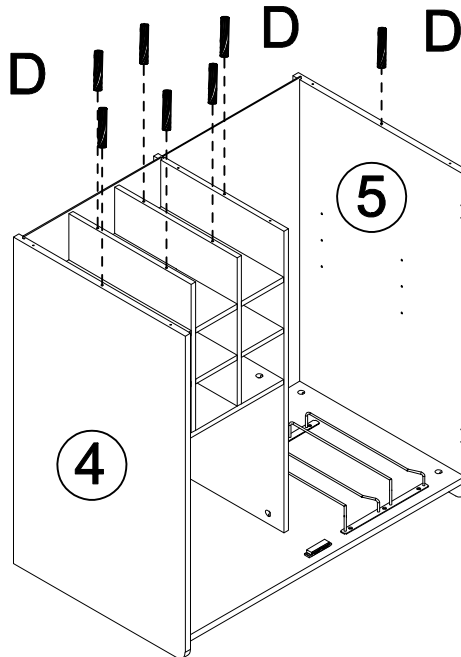
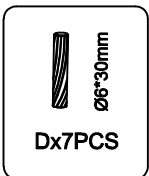

19

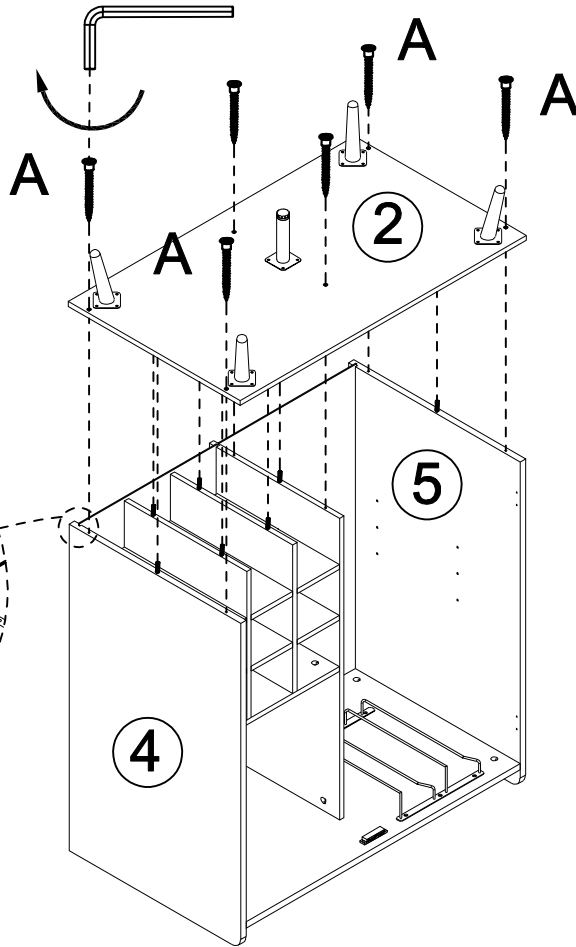
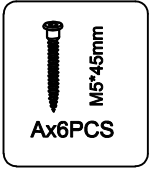

20

Two people are needed to flip the cabinet 180 degrees.

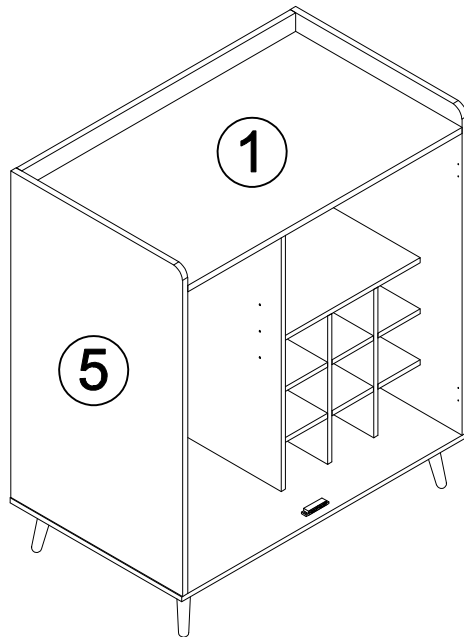

P14/21

21

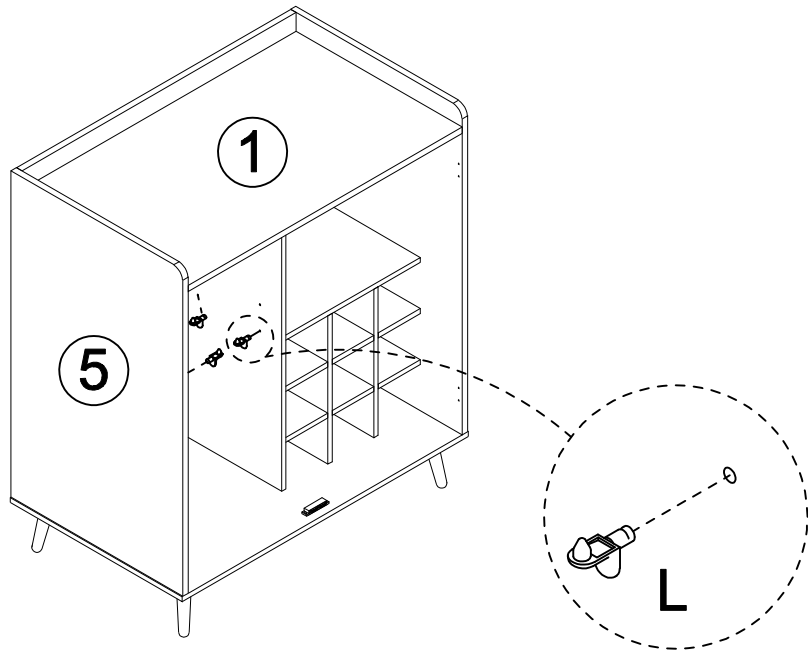

22

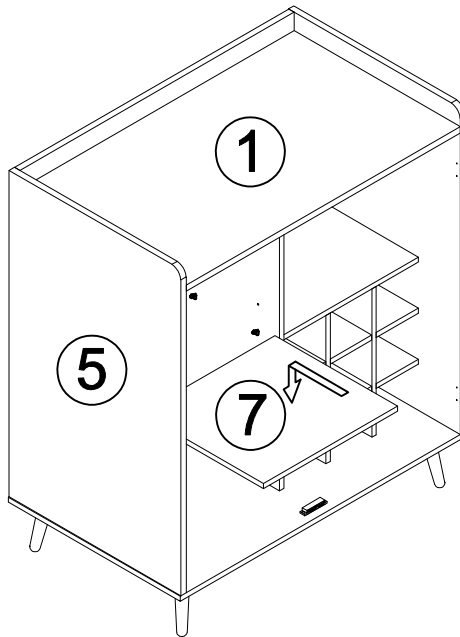
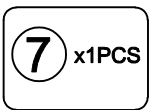

23

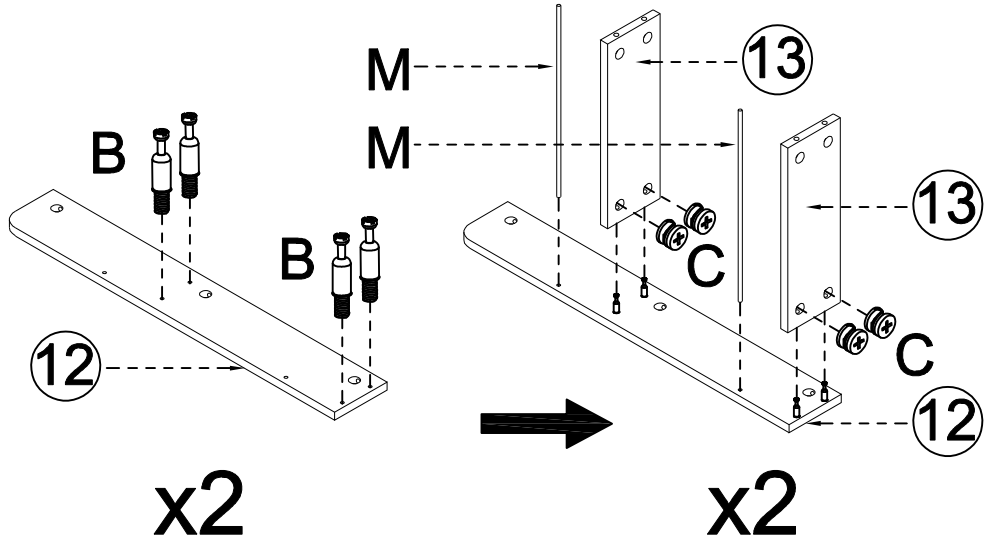
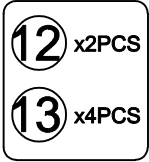
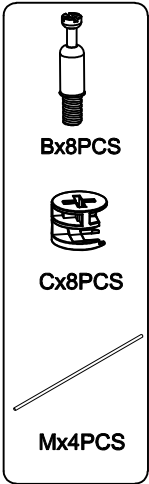

24

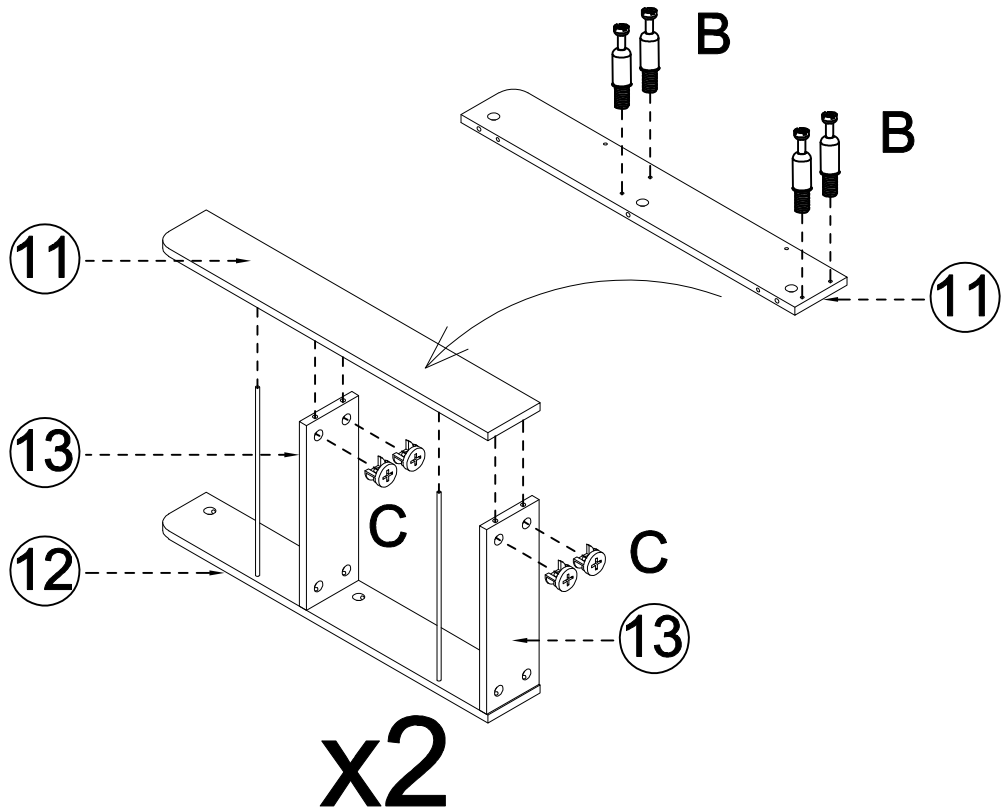
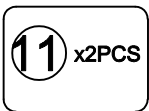
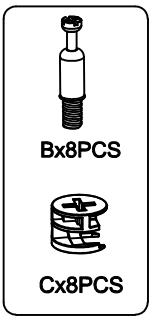

25

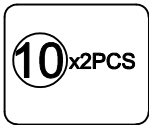
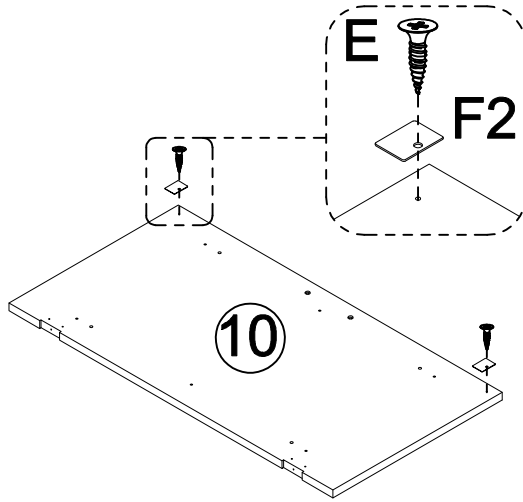
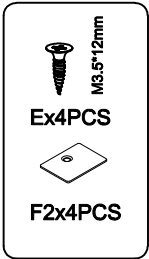

x2

26

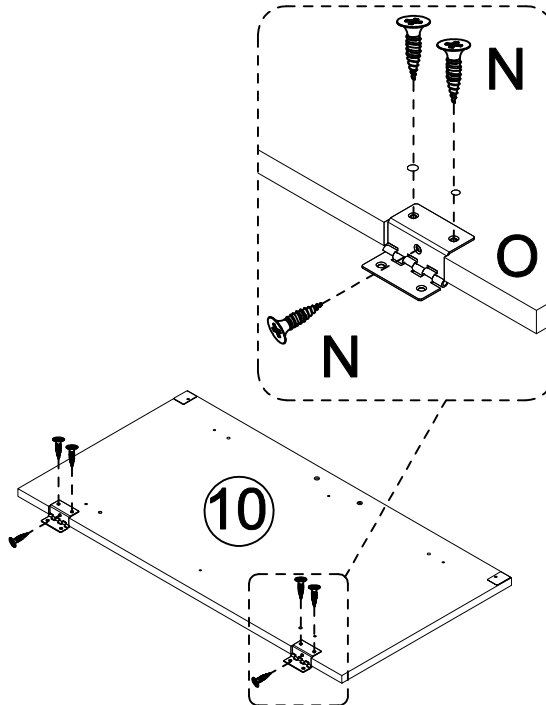
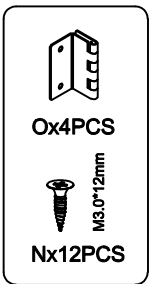

x2

27

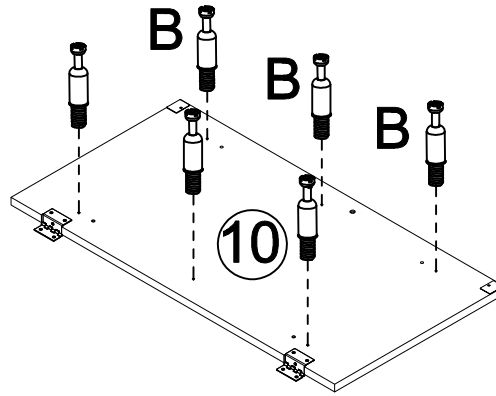
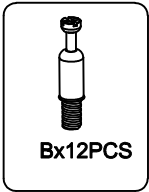

x2

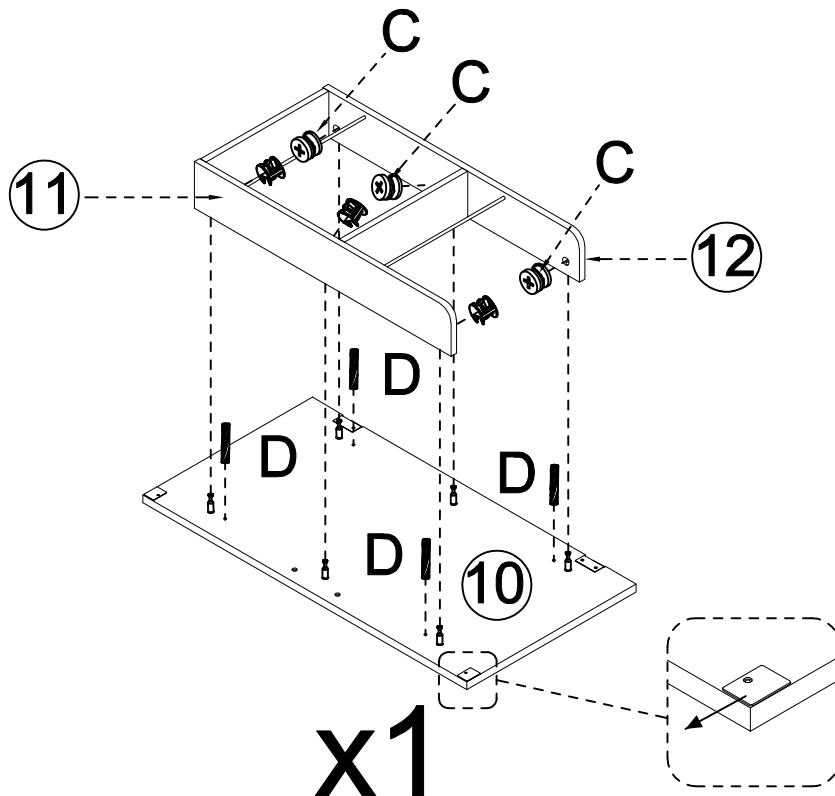
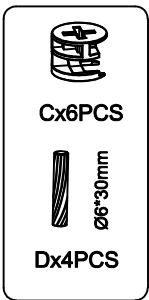

28

Install the right door panel



x1

29

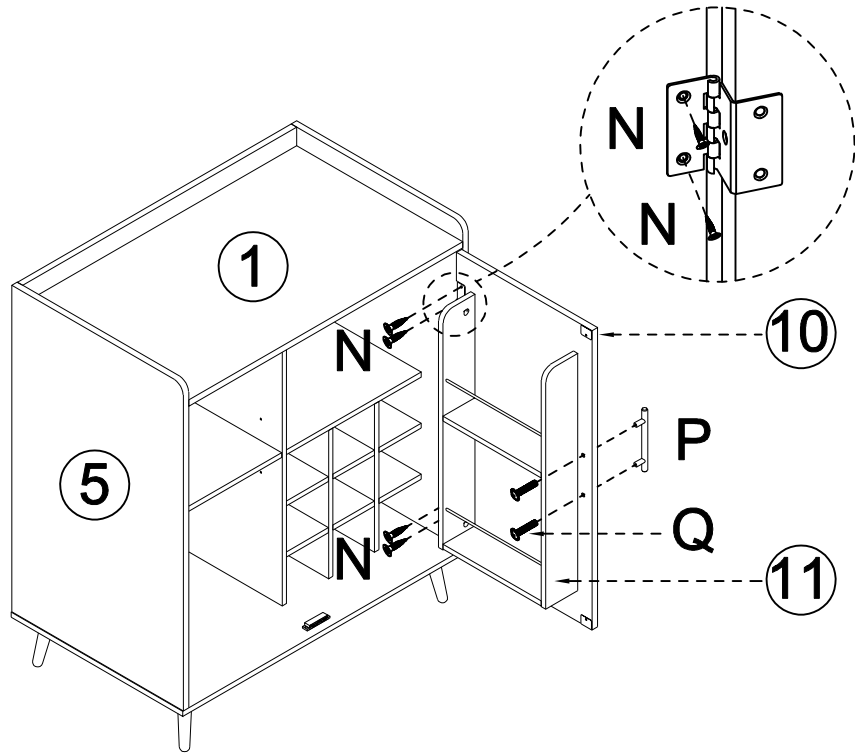

-  Nx4PCS
-  Px1PCS
-  Qx2PCS



Two people are recommended to assemble the door panel when installing it.



30

Install the left door panel

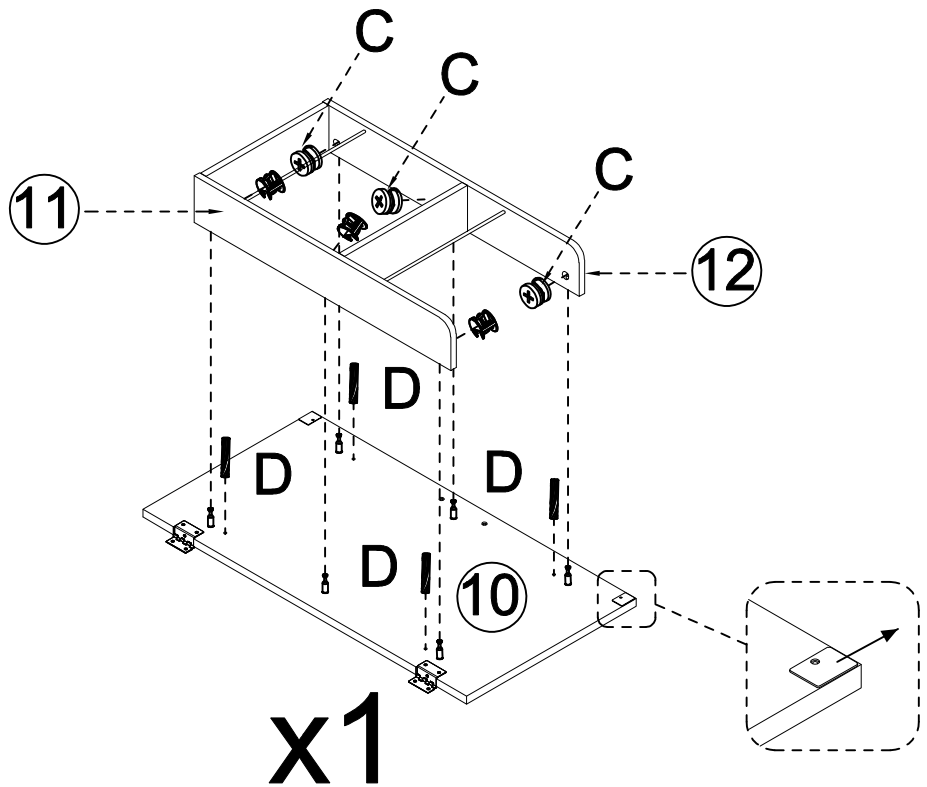
-  Cx6PCS
-  Dx4PCS



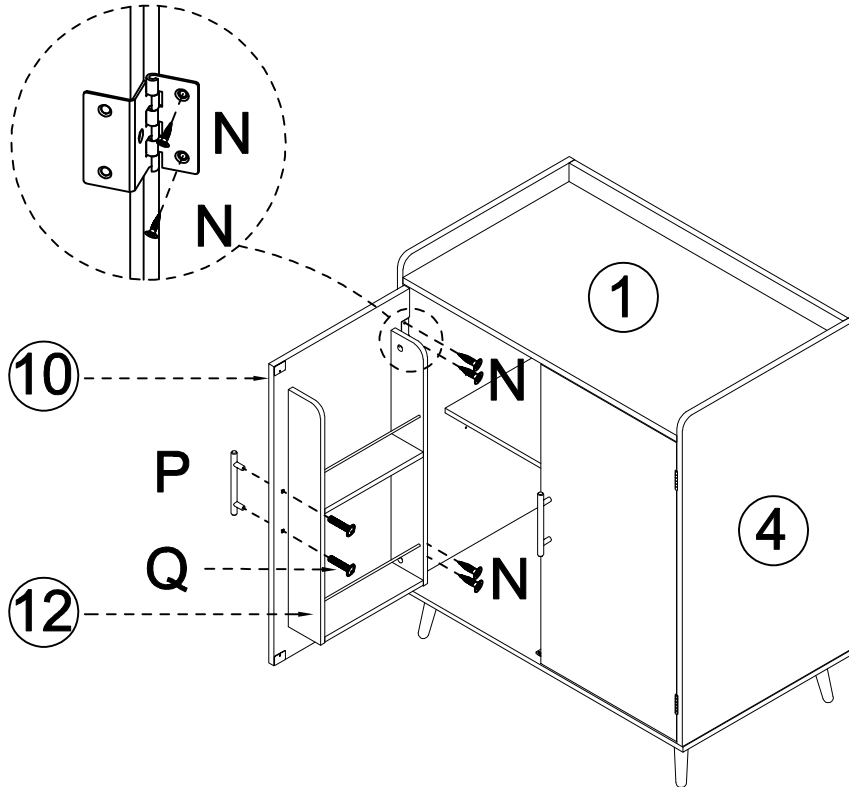

31

-  M3,0*12mm
Nx4PCS
-  Px1PCS
-  M4*20mm
Qx2PCS





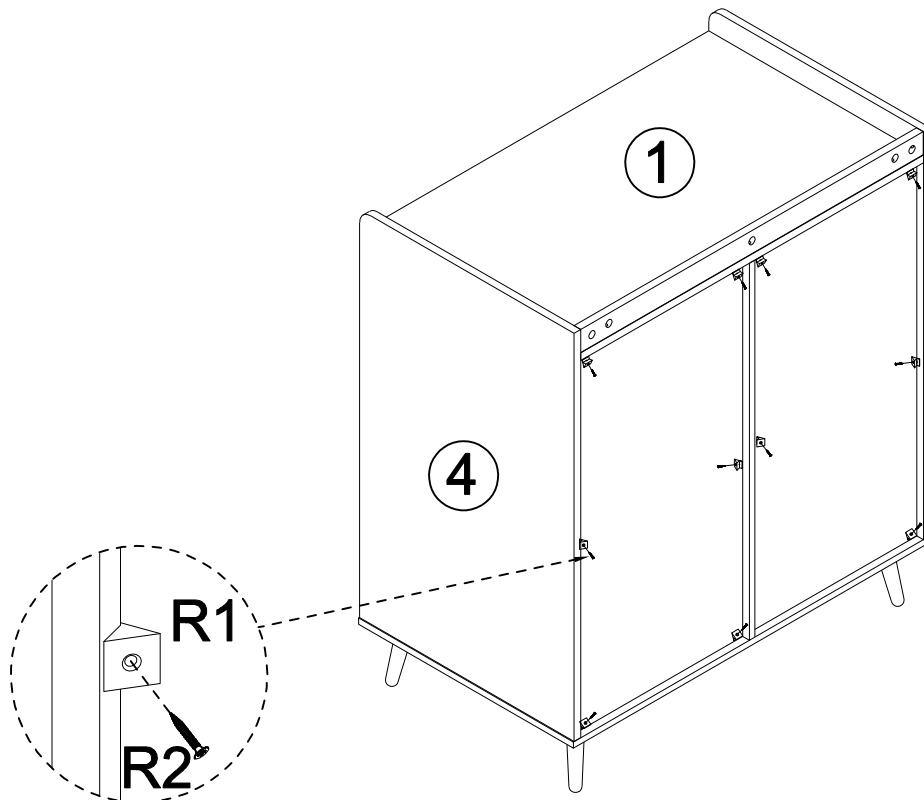

Two people are recommended to assemble the door panel when installing it.

32

-  R1x12PCS
-  $\varnothing 3 \times 16$ mm
R2x12PCS



33

-  S1x2PCS
-  S2x2PCS
M4*12mm
-  S3x2PCS
M4*35mm
-  S4x2PCS

