

**ASSEMBLY INSTRUCTIONS / INSTRUCTIONS
D'ASSEMBLAGE / INSTRUCTIVO DE ARMADO**

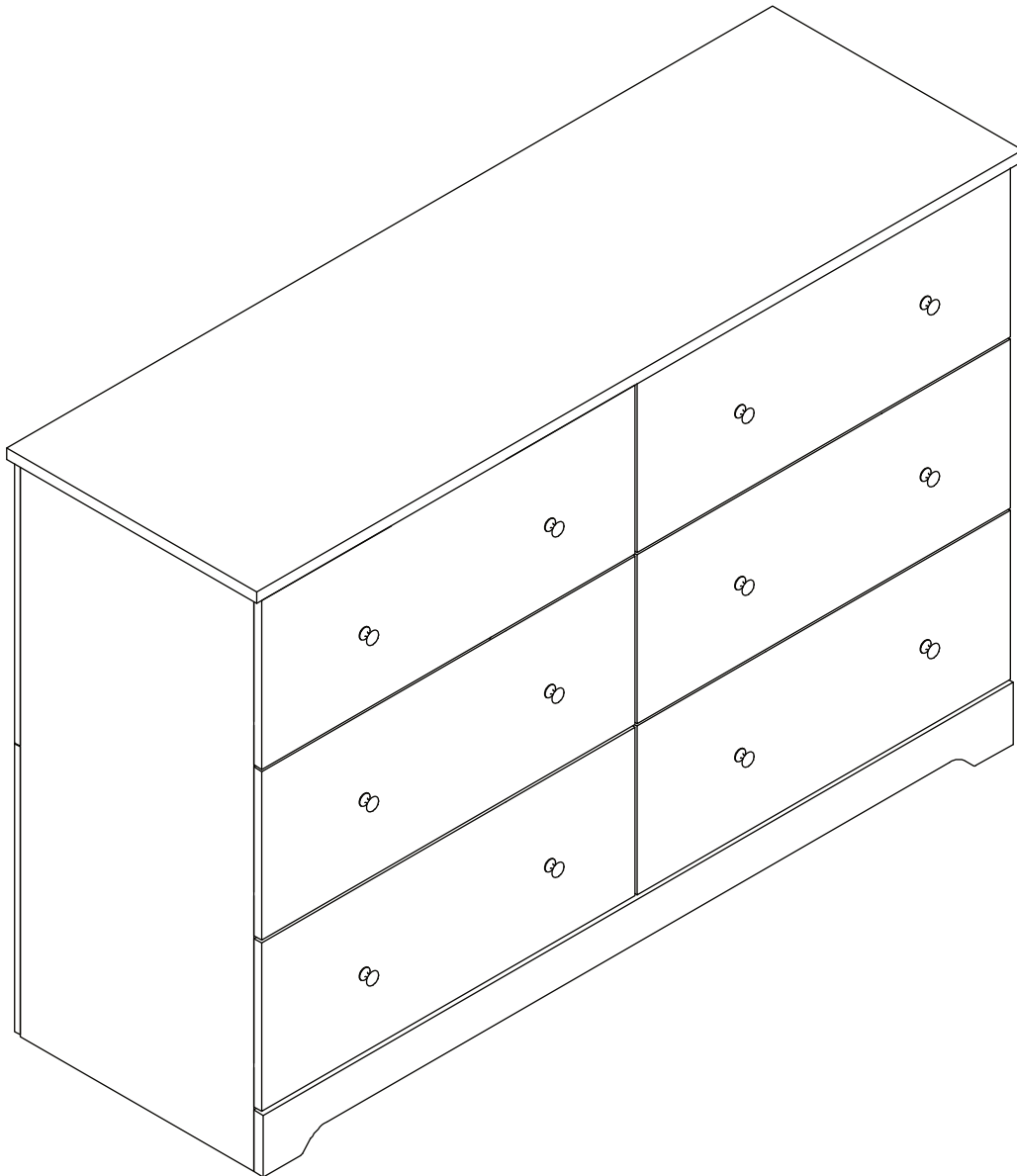

PRODUCT ASSEMBLY VIDEO

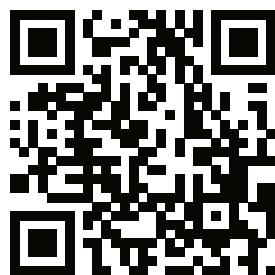

NOTES ON ASSEMBLY / NOTES POUR L'ASSEMBLAGE / NOTAS SOBRE EL ENSAMBLE

- To ensure ease of assembly read all instructions before assembly and follow step by step illustrations.
- Keep instructions for future use.
- Adult assembly required.  2 person required. 
- Due to the presence of small parts during assembly, keep out of reach of children until assembly is complete.

- Pour assurer l'assemblage facile veuillez lire toutes les instructions avant l'assemblage et veuillez suivre les illustrations pour chaque etapes.
- Veuillez garder ces instructions pour l'usage ulterieur.
- Assemblage requis pas un adulte.  2 personnes requises. 
- Due a la presence de petite pieces durant l'assemblage, veuillez garder hors de porter des enfants jusqu'a ce que l'assemblage soit completer.

- Para garantizar la facilidad de ensamble lea las instrucciones antes de iniciar y siga paso a paso las ilustraciones.
- Guarde las instrucciones para futuras referencias.
- El ensamble requiere de un adulto.  2 personas requeridas. 
- Debido a que hay piezas pequeñas, mantenga fuera del alcance a los niños durante el ensamble, hasta que haya terminado.

MAINTENANCE TIPS / CONSEILS D'ENTRETIEN / CONSEJOS DE MANUTENIMIENTO

- Never let liquids or damp cloths sit on this furniture.
- Never use chemical cleaning products. They can damage the finish. For cleaning, use only a slightly damp cloth and wipe dry.
- To avoid dulling of the finish, do not place furniture in direct sunlight.
- Do not put plastic or rubber rings under appliances. Use cloth of felt protectors.
- To clean, use a soft or slightly damp cloth, then wipe with a clean, dry cloth.

- Ne jamais laisser de liquide ou linge humide sur le meuble.
- Ne jamais utiliser de nettoyeurs à base de produits chimiques, cela va endommager le fini. Utiliser seulement un linge légèrement humide.
- Ne pas placer le meuble directement au soleil pour prévenir le ternissement.
- Évitez de déposer des appareils avec des rondelles de plastique ou de caoutchouc. Utilisez un protecteur en tissu ou en feutre.
- Pour nettoyer, utilisez un linge doux ou légèrement humecté. Essayez par la suite avec un linge propre et sec.

- Nunca deje un líquido o un trapo húmedo sobre el mueble.
- Nunca utilice limpiadores a base de químicos, estos dañaran le acabado. Use sólo un paño húmedo.
- No esponga el mueble directamente al sol para prevenir empañamiento.
- Evite apoyar aparatos con redondeles de plástico o de goma. Utilizar un protector de tela o de fieltro.
- Para limpiar, utilice un trapo suave o ligeramente humedecido. Seque luego con un trapo limpio y seco.

WARNING **AVERTISSEMENT / ADVERTENCIA**

Please use your furniture correctly and safely. Improper use can cause safety hazards, or damage to your furniture or household items.

Children have died from furniture tipover. To reduce the risk of furniture tipover:

- ALWAYS install the anti-tip device provided.
- NEVER put a TV on this product.
- NEVER allow children to stand, climb, or hang on any drawers, doors, or shelves.
- NEVER open more than one drawer at a time.
- DO NOT defeat or remove the drawer interlock system; it is an important stability and safety system.
- PLACE heaviest items in the lowest drawers.

Use of tip-over restraints reduce, but does not eliminate, the risk of tip-over.

Prière d'utiliser le mobilier à bon escient et avec prudence. Une mauvaise utilisation peut être à l'origine de risques d'accident ou peut endommager le mobilier et les articles ménagers.

Des enfants sont morts à cause du basculement de meubles. Pour réduire le risque de basculement des meubles:

- TOUJOURS installer le dispositif anti- basculement fourni.
- NE JAMAIS placer un téléviseur sur ce produit.
- NE JAMAIS permettre aux enfants d'être dessus, de grimper, ou de se pendre après des tiroirs, portes ou étagères.
- NE JAMAIS ouvrir plus d'un tiroir à la fois
- NE PAS défaire ou retirer le système de verrouillage du tiroir; il s'agit d'un important système de stabilité et de sécurité.
- PLACEZ les articles les plus lourds dans les tiroirs les plus bas.

L'utilisation de dispositif antibasculement ne peut que réduire les risques de basculement, sans les éliminer

Por favor use el mobiliario correcta y seguramente. El mal uso puede causar riesgos de seguridad o daño a las unidades o artículos domésticos.

Niños han muerto por volcamiento de muebles. Para reducir el riesgo de que los muebles se vuelquen:



- SIEMPRE instale el dispositivo antivuelco suministrado.
- NUNCA coloque un televisor sobre este producto.
- NUNCA permita que los niños se paren, trepen, o cuelguen de los cajones, puertas o estantes.
- NUNCA abra más de un cajón a la vez.
- NO anule ni retire el sistema de bloqueo de los cajones; es un importante sistema de estabilidad y seguridad.
- COLOQUE los artículos más pesados en los cajones de abajo.

El uso de sujetadores para evitar el vuelco sólo puede disminuir el riesgo de un vuelco, pero no lo elimina.

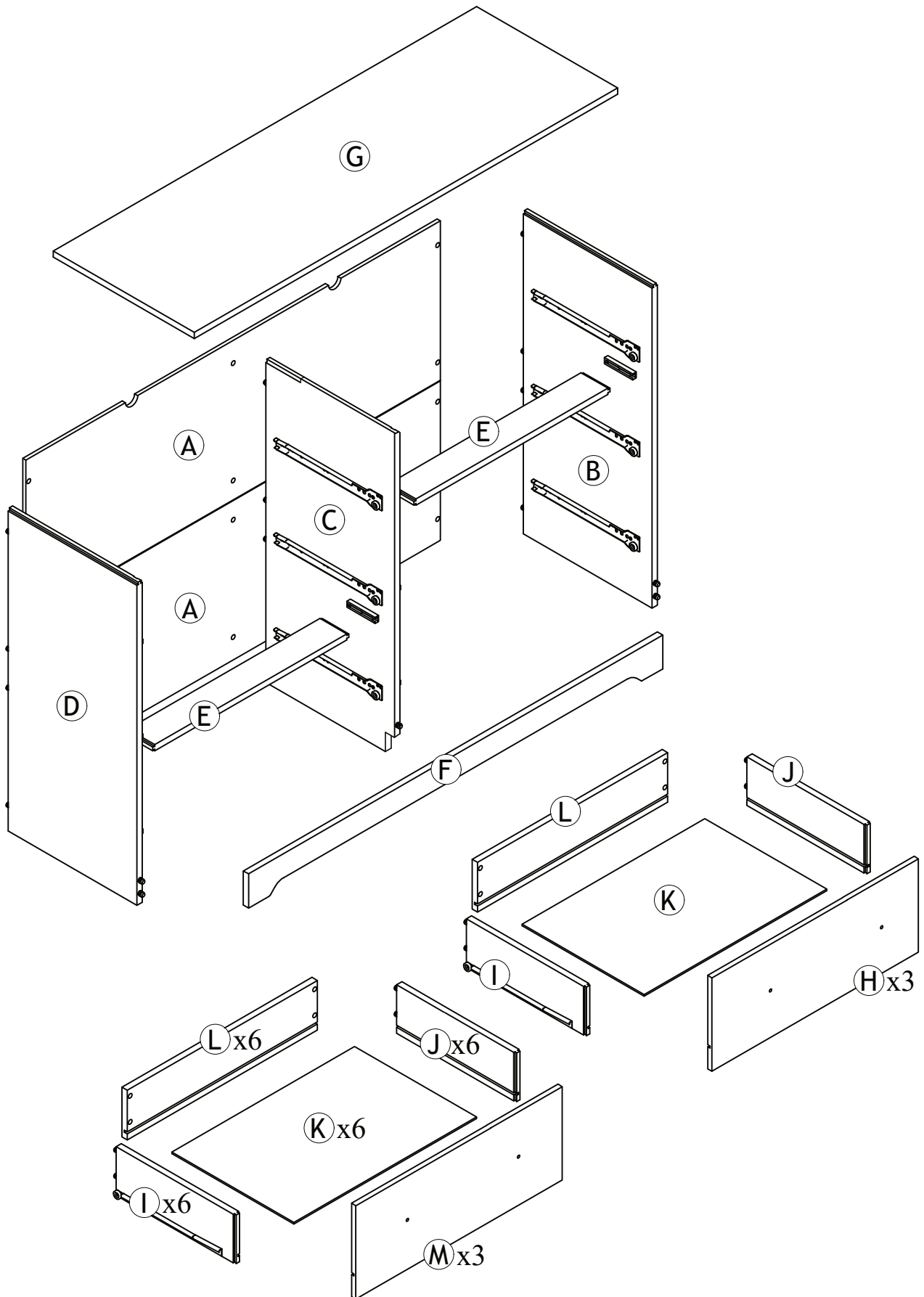
PARTS IDENTIFICATION
IDENTIFICATION DES PIÈCES
IDENTIFICACIÓN DE LAS PARTES





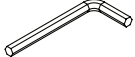

HARDWARE QUINCAILLERIE / HERRAJE

(A)	Screw M4 x 16mm  12 units	(B)	Handle  12 units	(C)	Allen Phillips Key M4  1 unit
(D)	Allen Key L M3  1 unit				

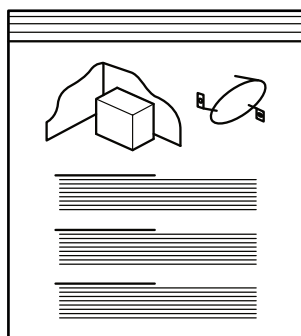
- Hardware quantity may supplied more than it required. Please keep spares and tools for future use.
- La cantidad de hardware puede suministrarse más de lo requerido. Guarde los repuestos y las herramientas para uso futuro.
- La quantité de matériel peut fournir plus que nécessaire. Veuillez conserver les pièces de rechange et les outils pour une utilisation future.

FURNITURE TIPPING RESTRAINT SEGURO CONTRA VOLCADO DE MUEBLES DISPOSITIF DÉ SÉCURITÉ POUR MEUBLES

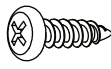

(AA)	Safety Bracket  4 units	(BB)	Restraint Strap  2 units
(CC)	Screw 5/8"  2 units	(DD)	Screw 2"  2 units

TOOLS NOT INCLUDED OUTILS PAS INCLUS / HERRAMIENTAS NO INCLUIDAS

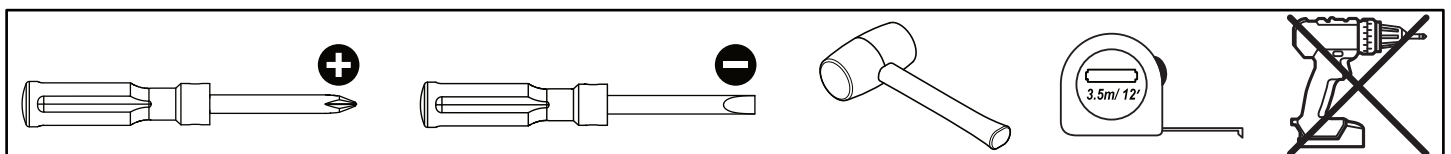

STEP 1

Layout parts on soft surface.

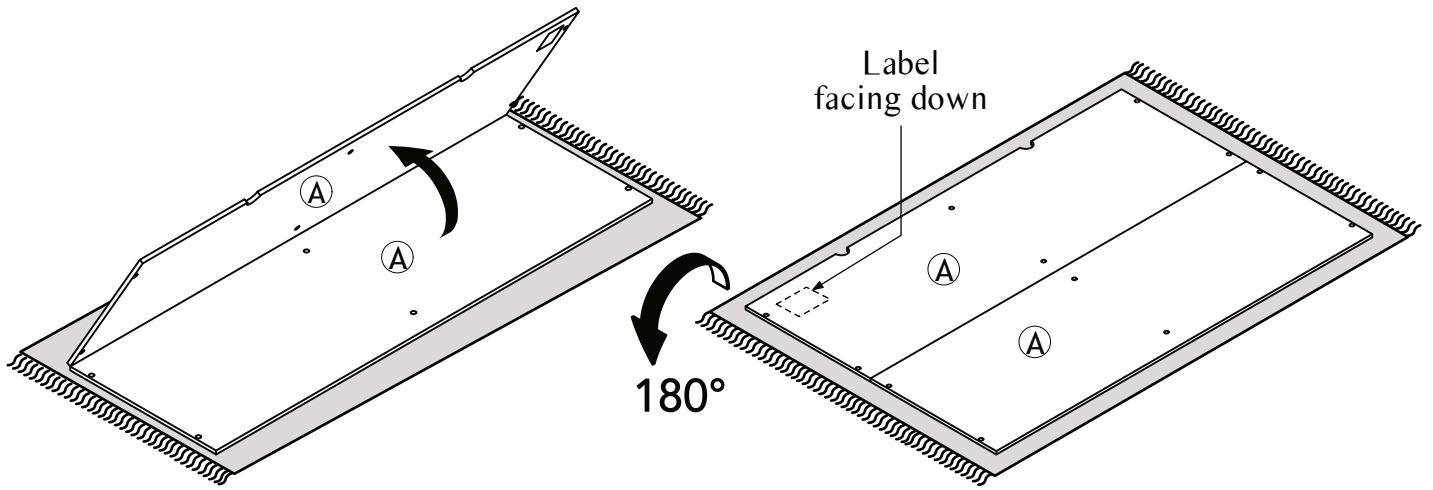

STEP 2

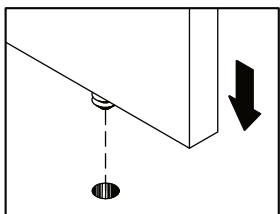
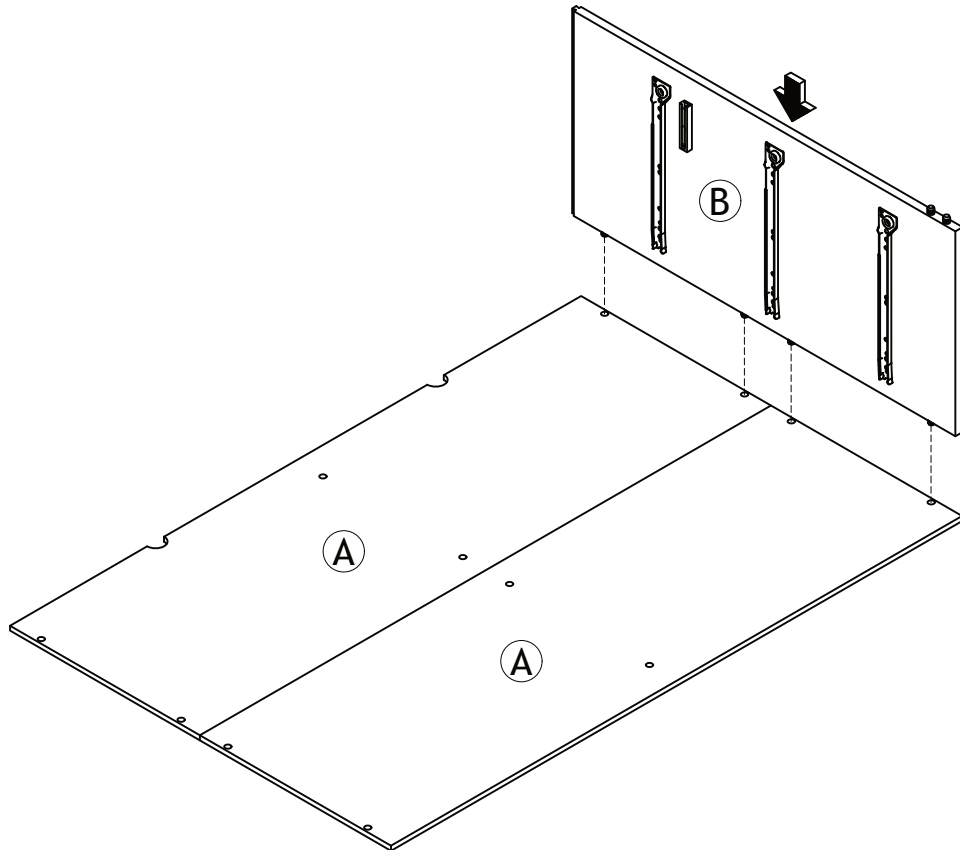

STEP 3

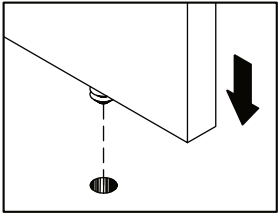
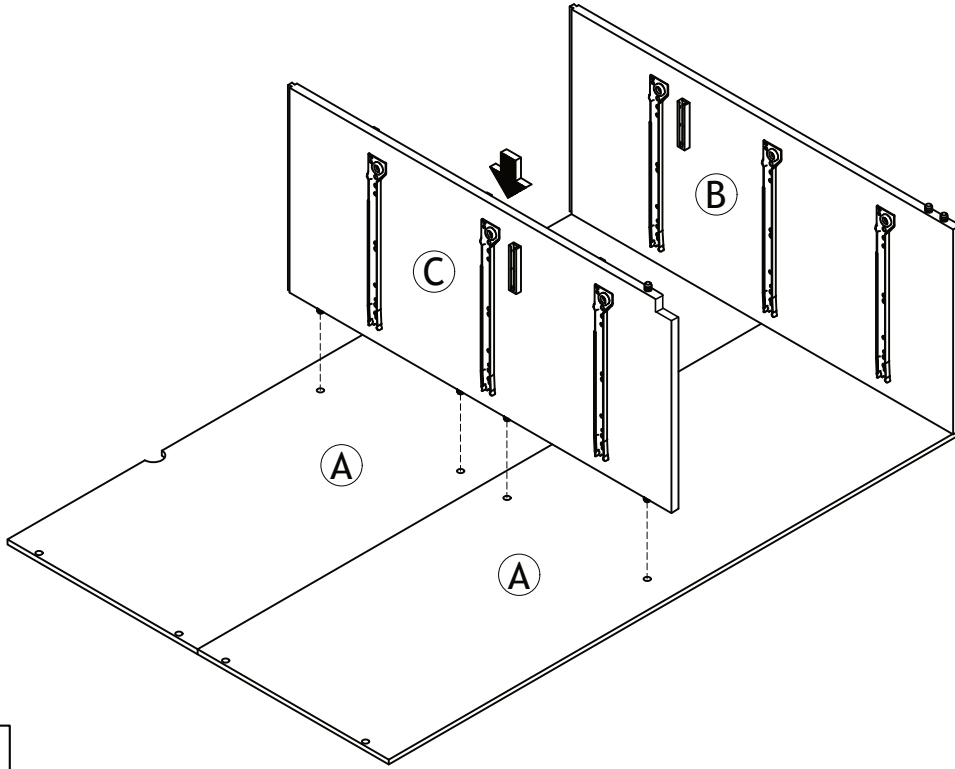

STEP 4

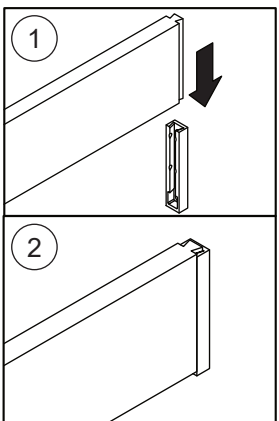
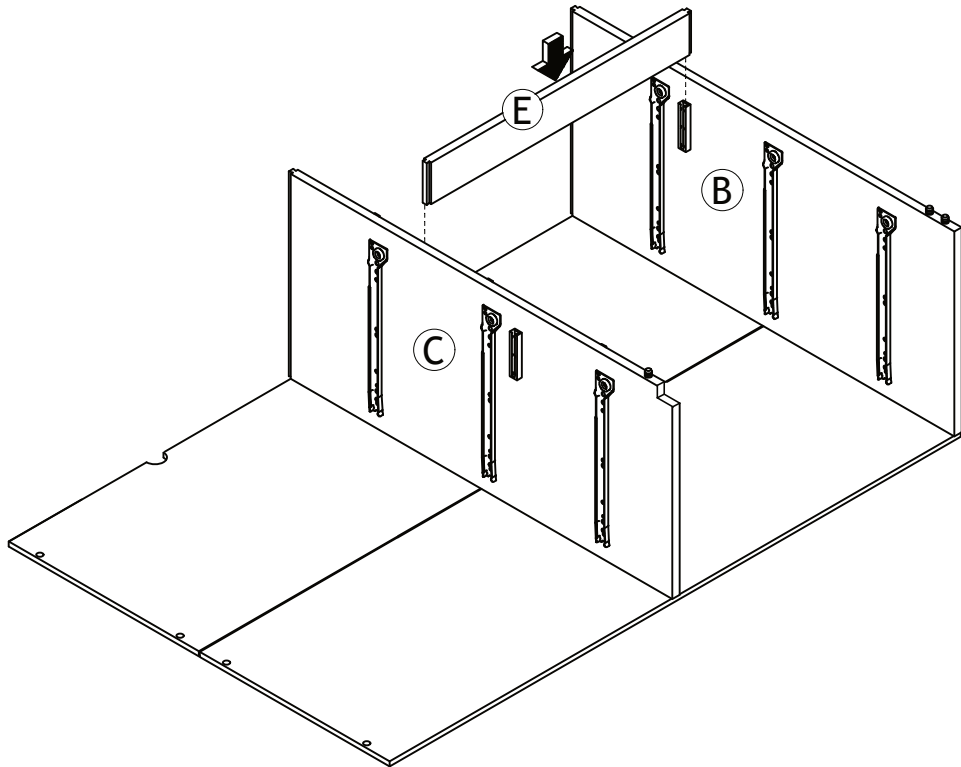

STEP 5

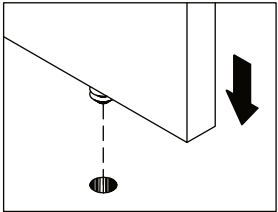
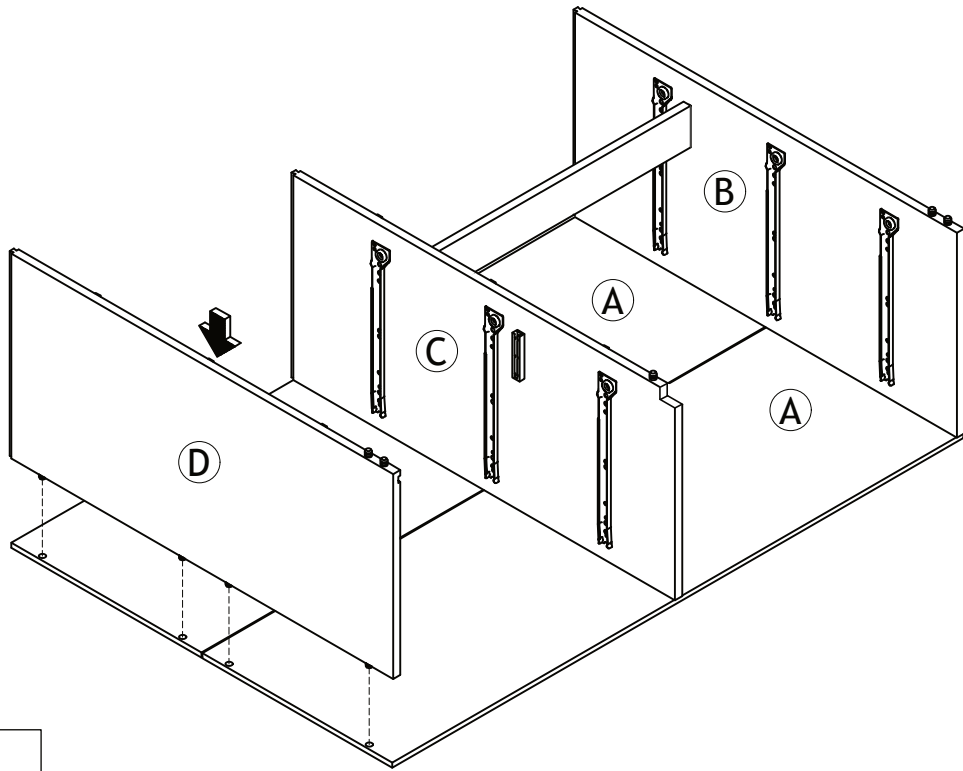

STEP 6

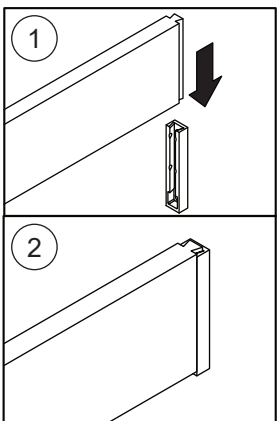
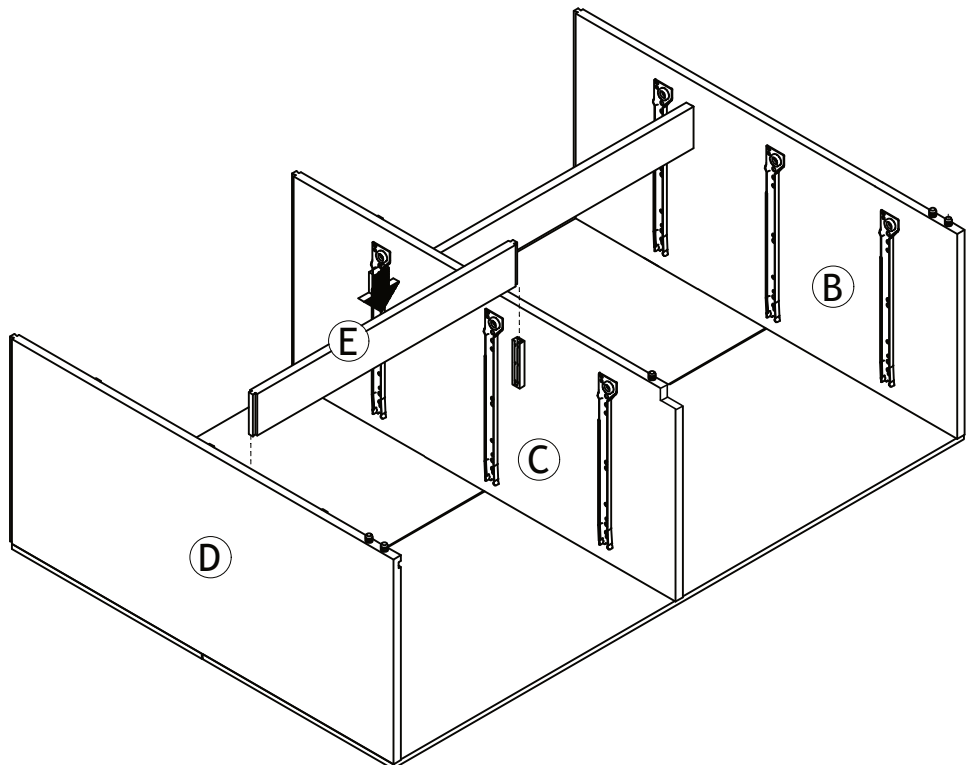

STEP 7

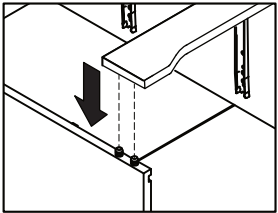
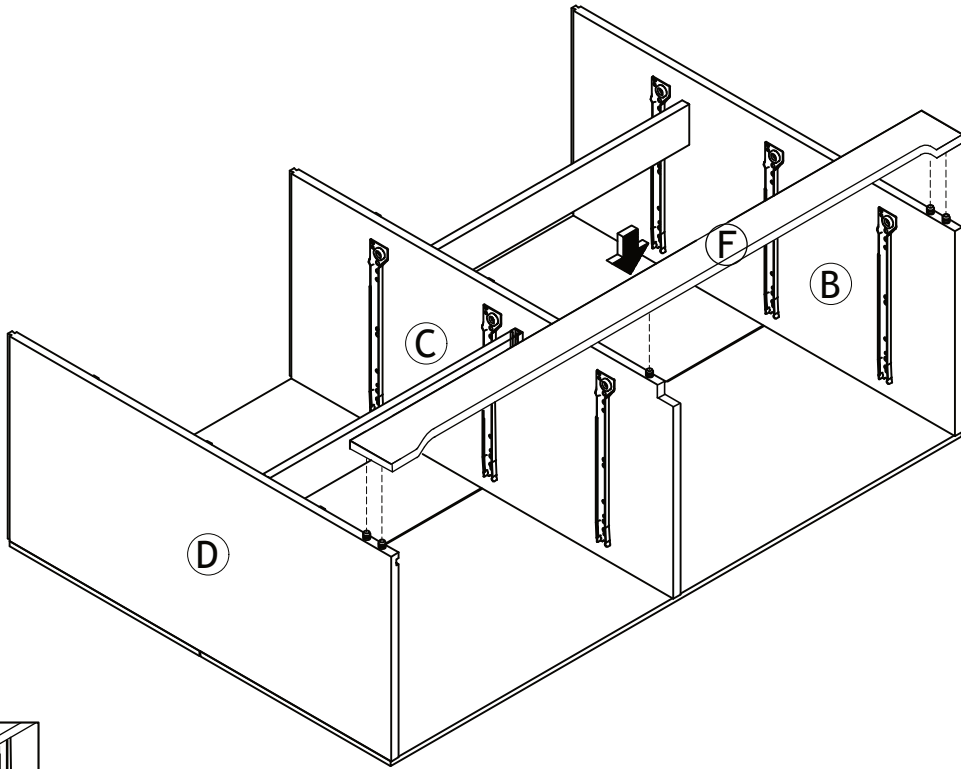

STEP 8

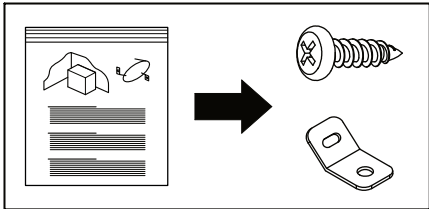

AA x 2	CC x 2

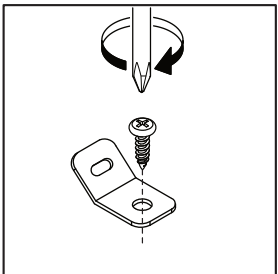
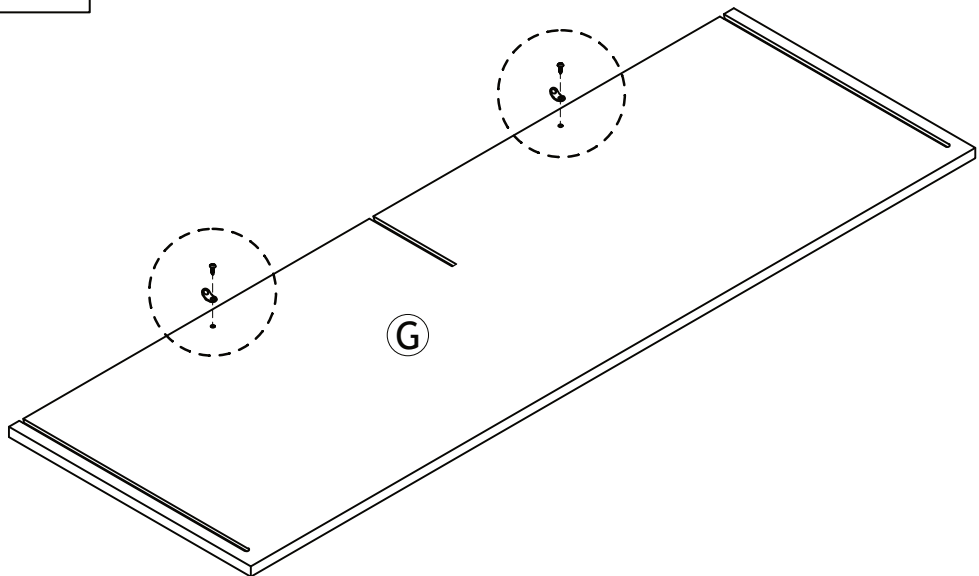

STEP 9

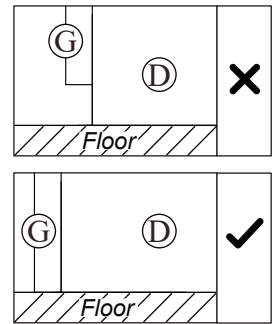
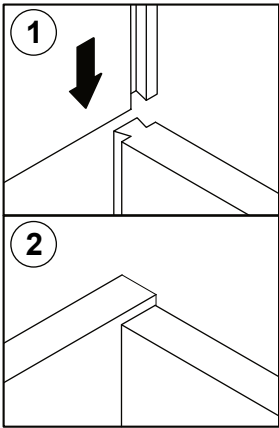
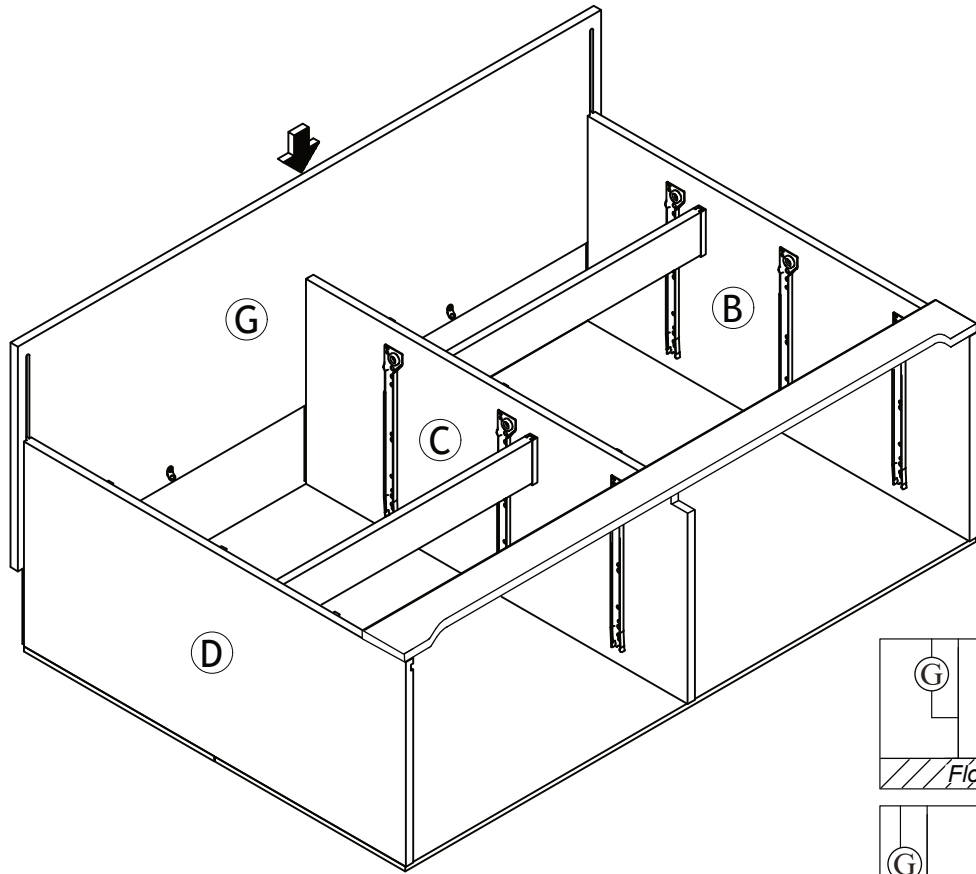

* Ensure both panels aligned to the floor

STEP 10

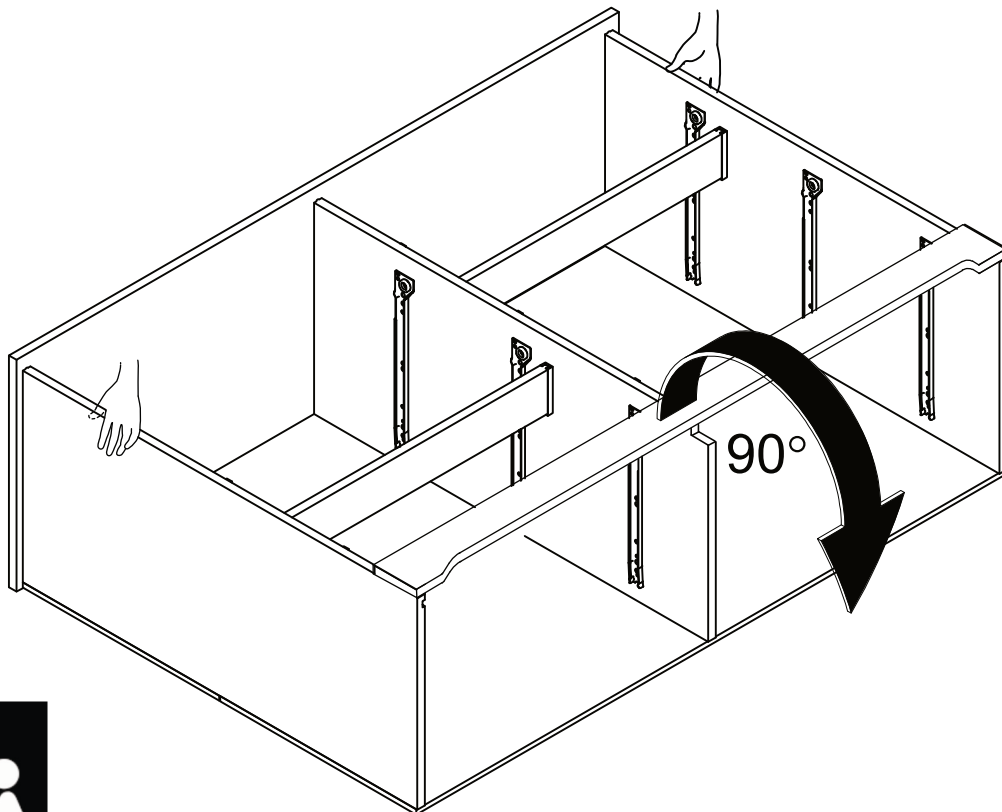

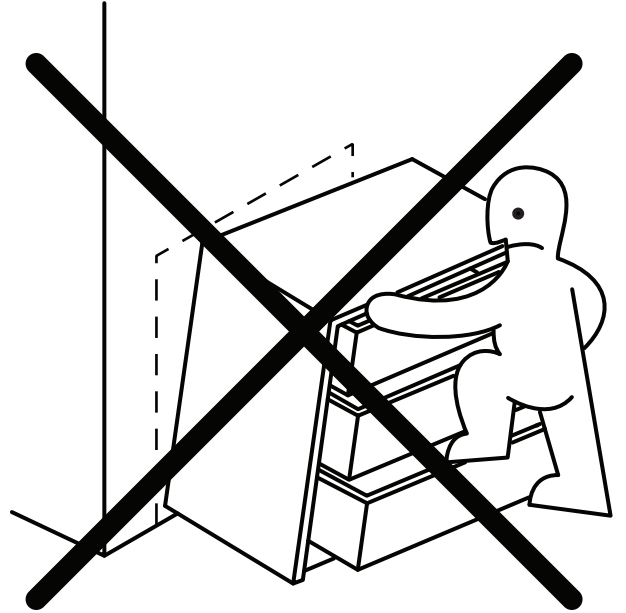
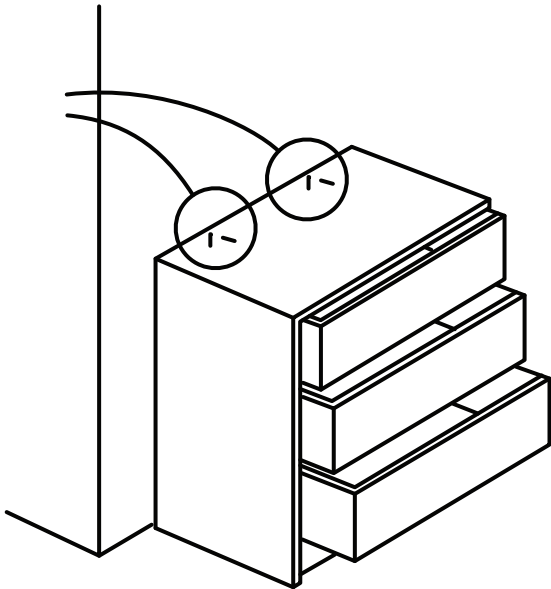

FURNITURE TIPPING RESTRAINT SEGURO CONTRA VOLCADO DE MUEBLES DISPOSITIF DÉ SÉCURITÉ POUR MEUBLES

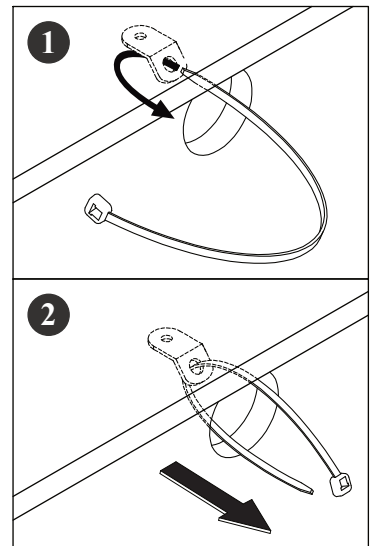
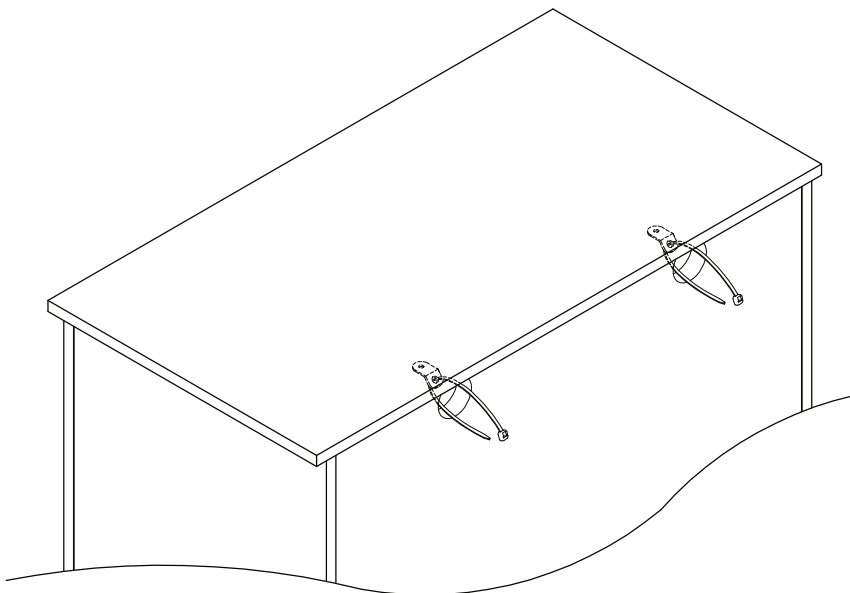
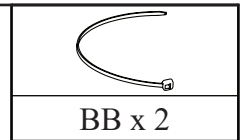
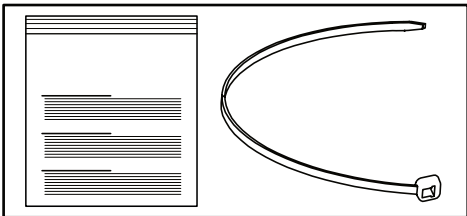

STEP 11

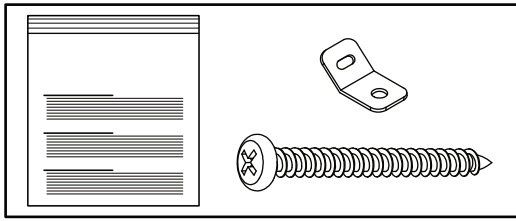



	
AA x 2	DD x 2

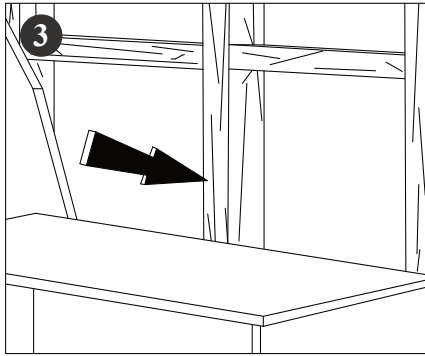

- Move the furniture unit to its final position to the wall.
- Locate a stud in the wall behind the unit. .

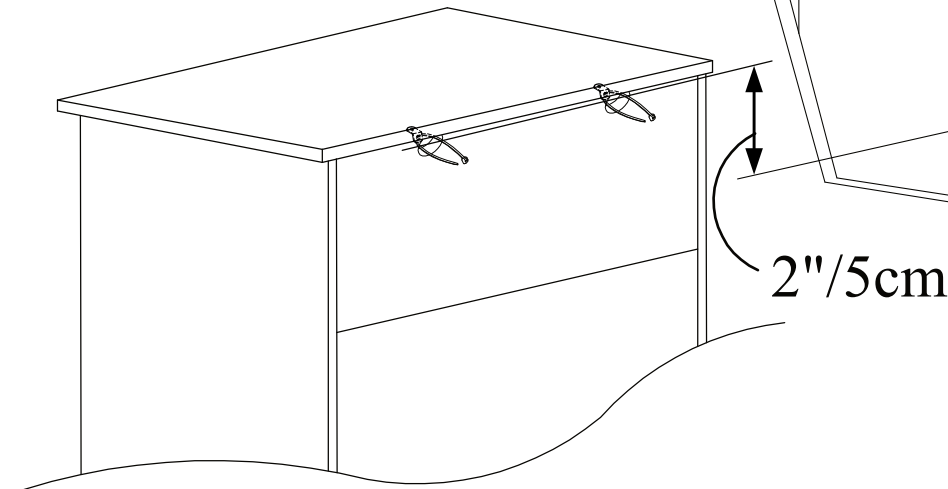

- Locate the other bracket on the wall in the wall stud, 2 inches below the safety bracket secured to the back of your unit. Attach to the wall stud using 2" screw through the smaller hole of bracket.

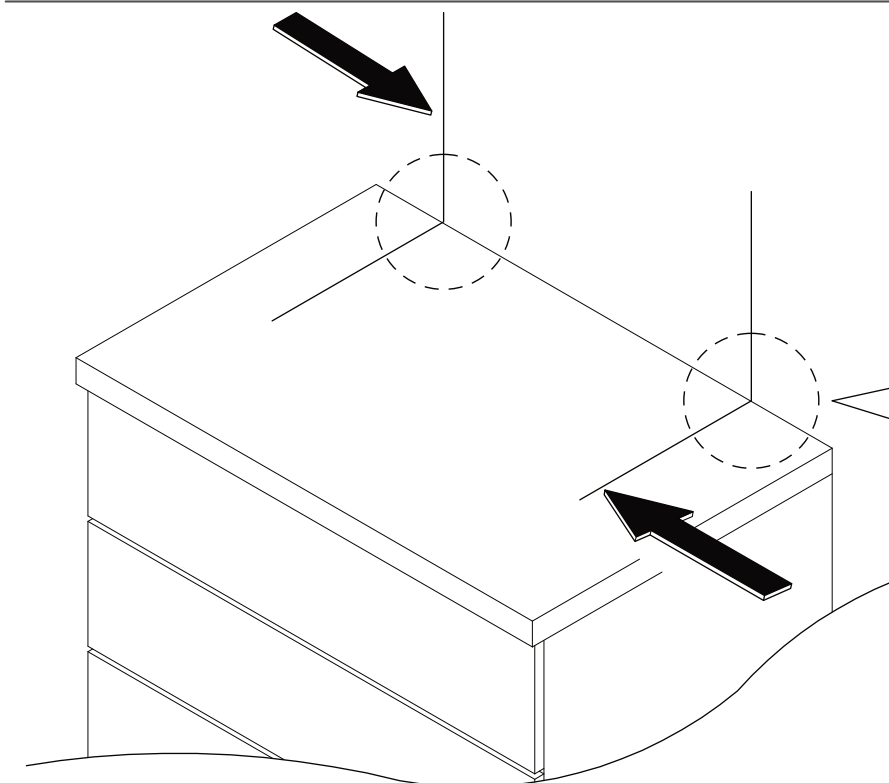
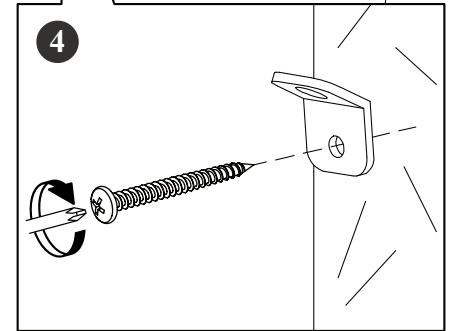
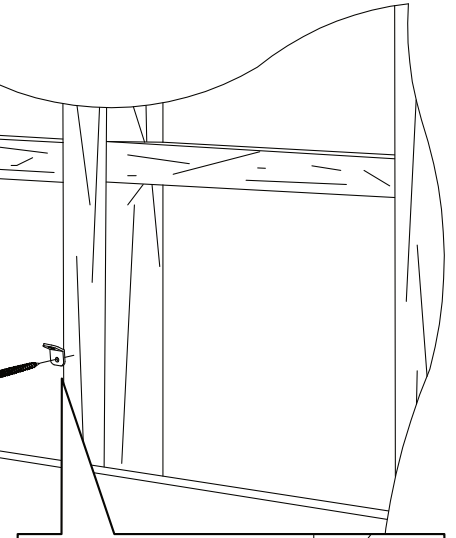

- Place the furniture into position so both safety brackets are vertically in line.
- Lace the end of the restraint strap through the larger hole in each safety bracket.
- Confirm that the strap is securely laced and locked.

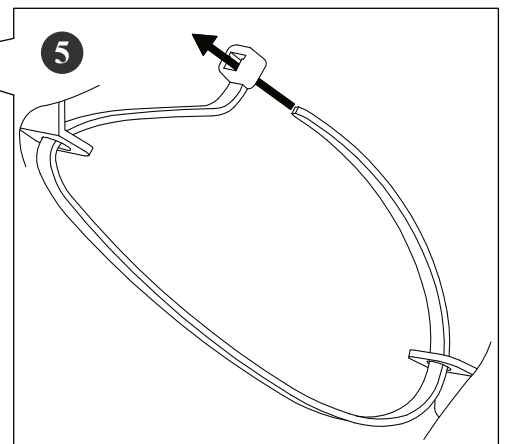

STEP 12

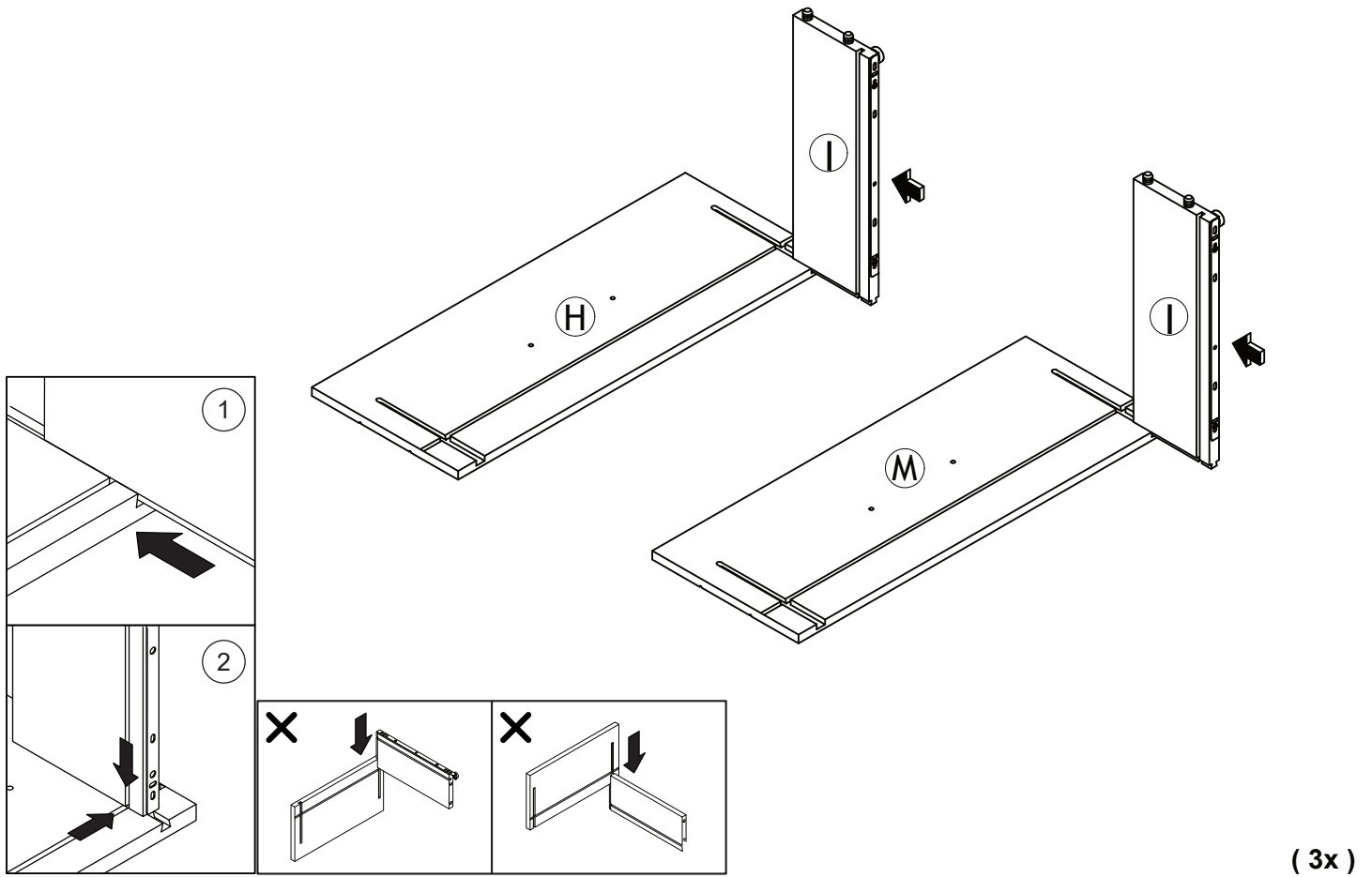

STEP 13

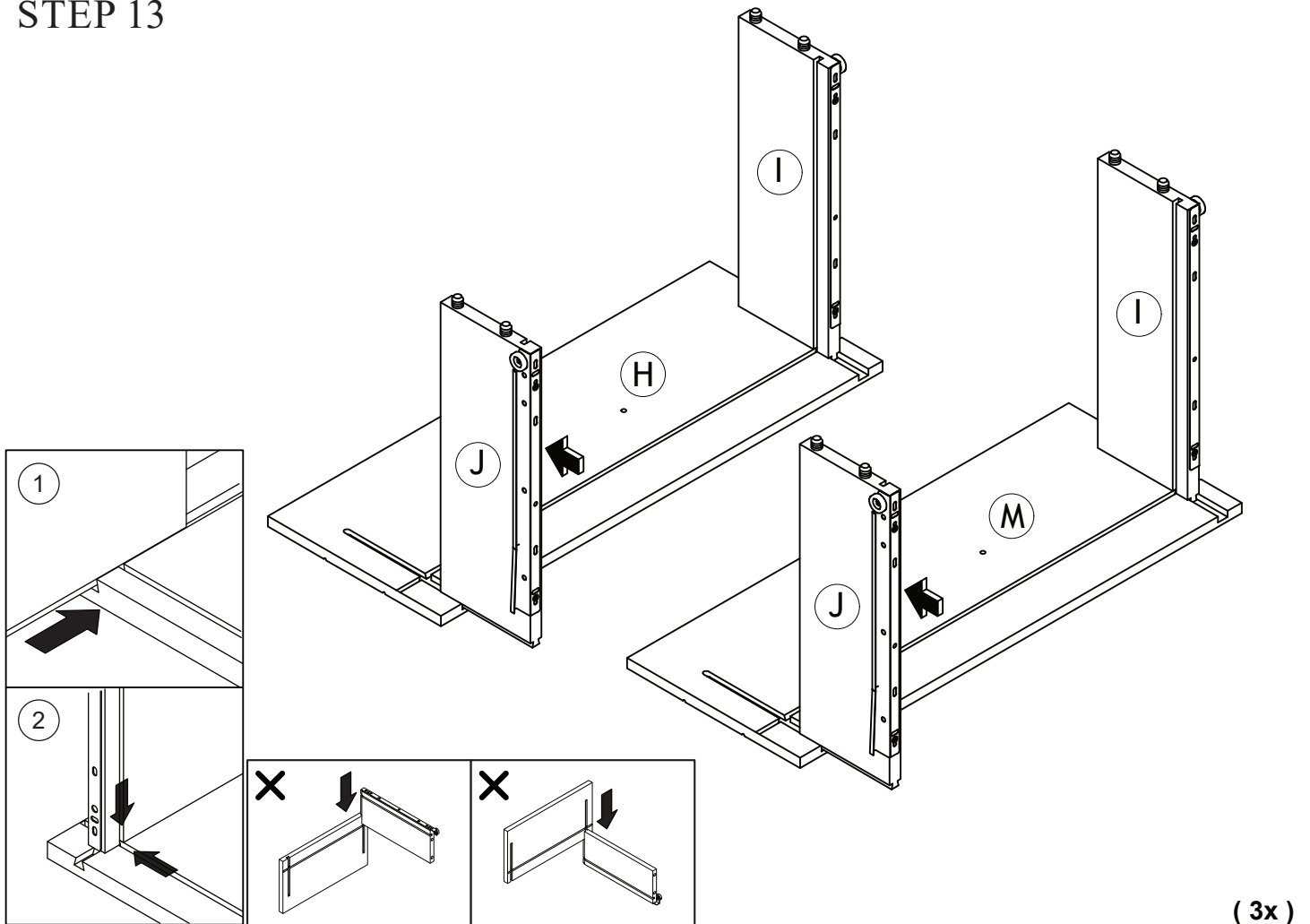

STEP 14

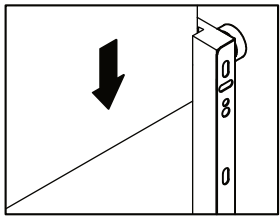
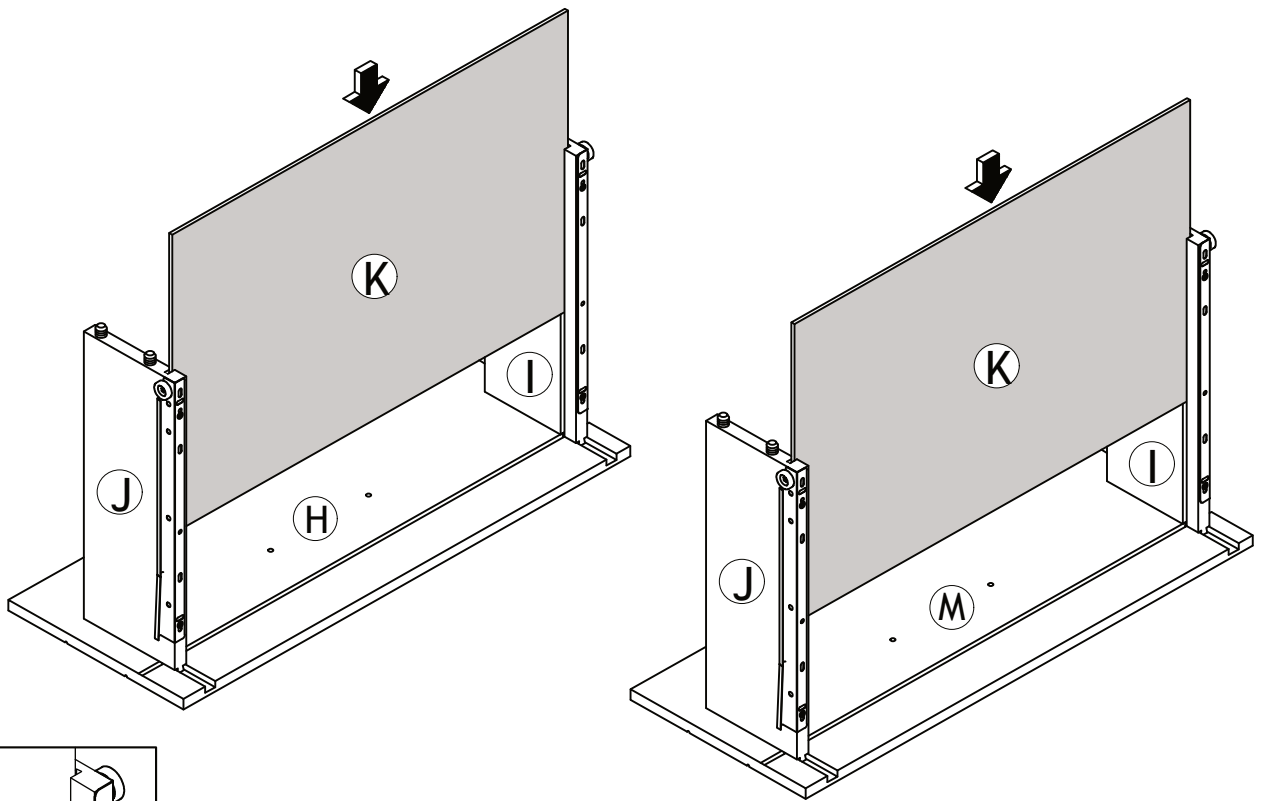

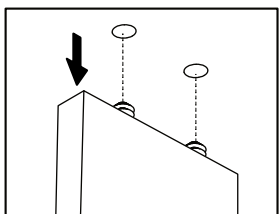
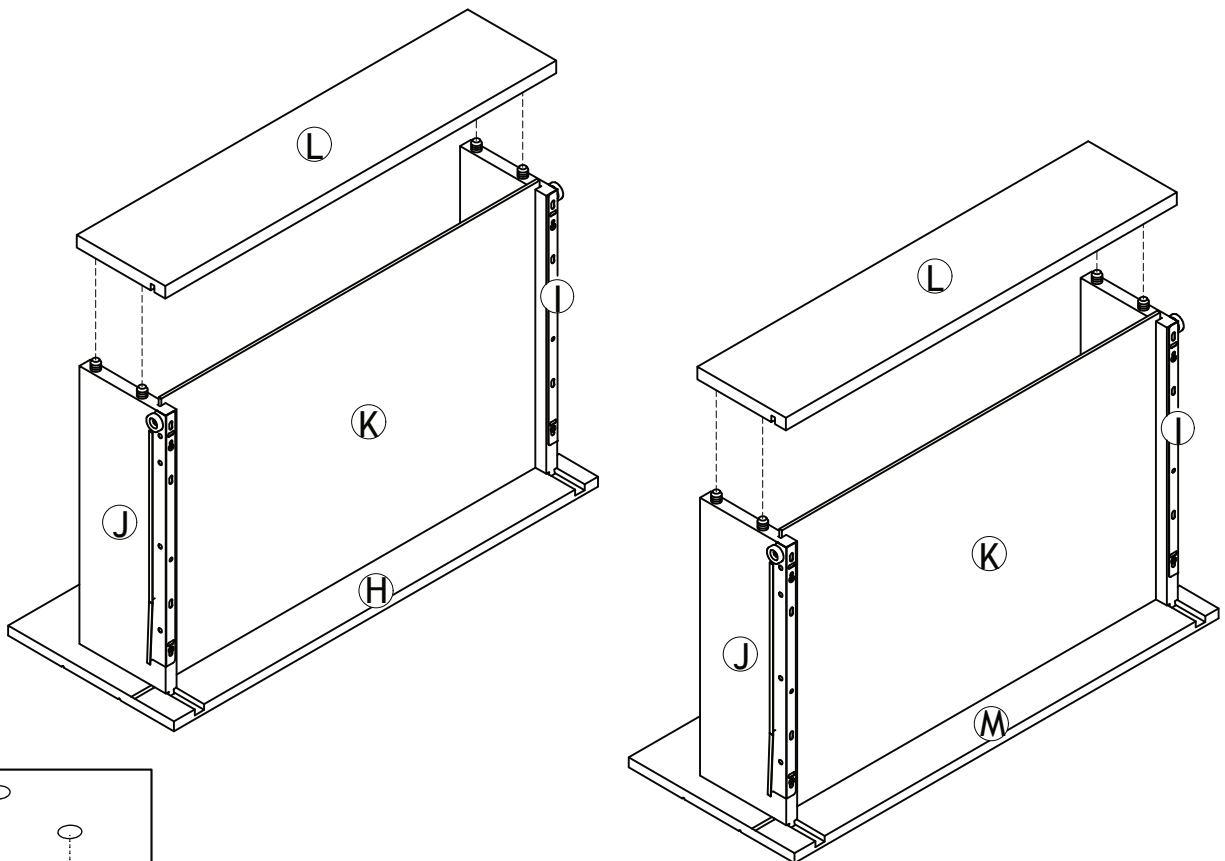

(3x)

STEP 15

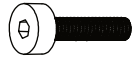

(3x)

STEP 16

	
A x 12	B x 12

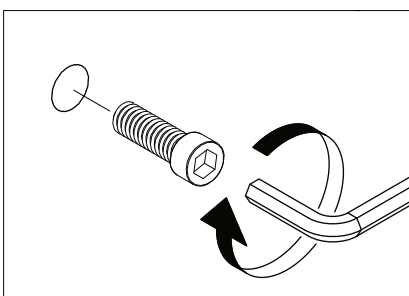
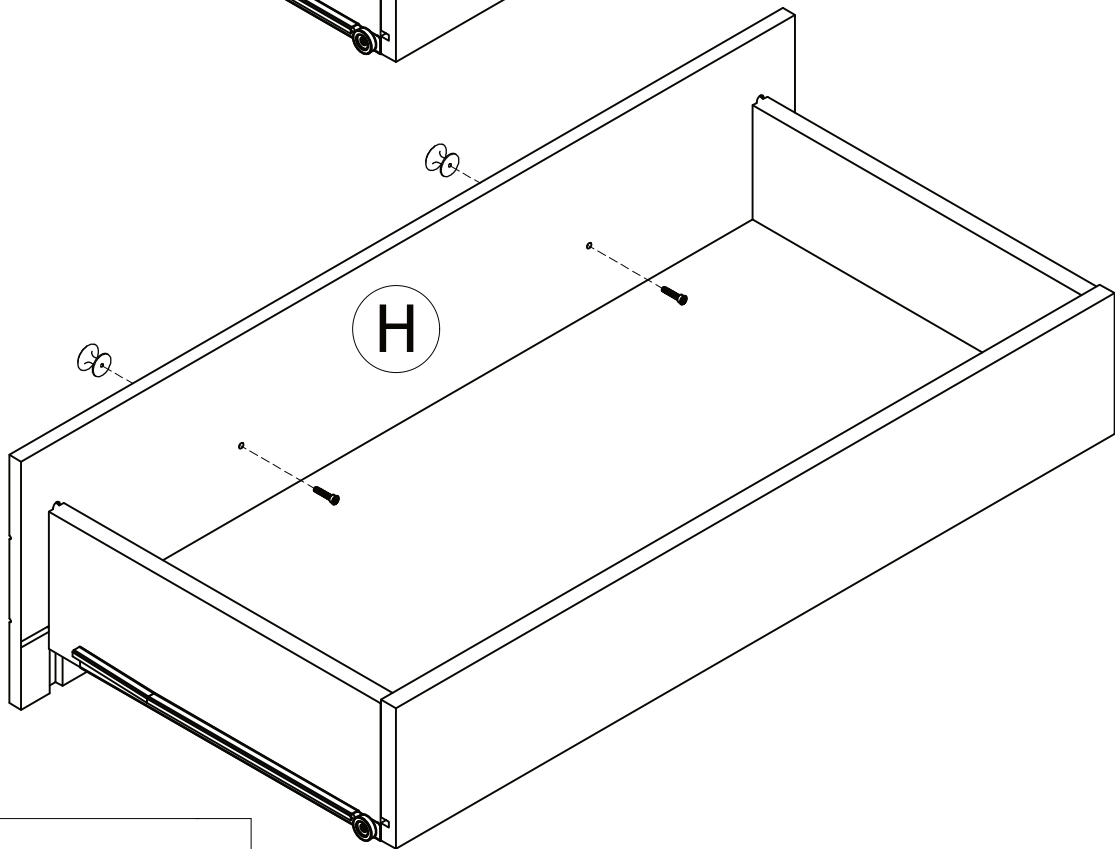
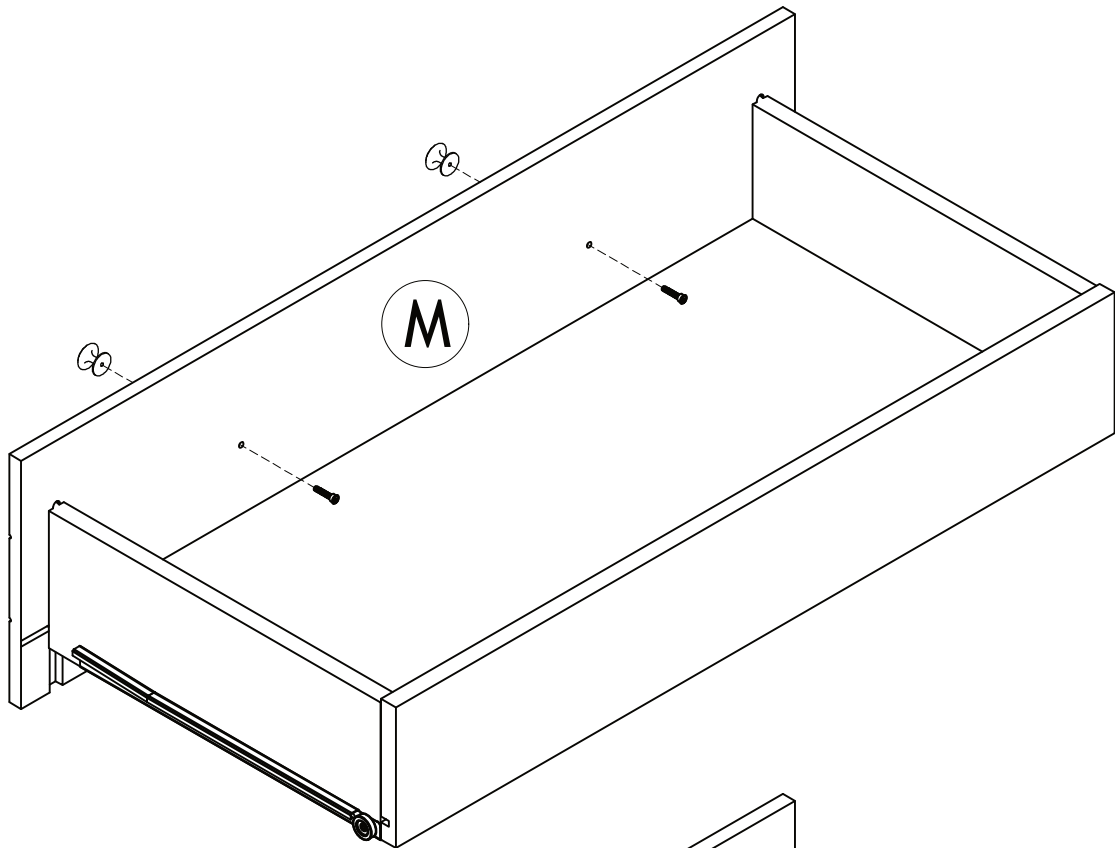

DRAWER INTERLOCK SYSTEM

SYSTÈME DE VERROUILLAGE DES TIROIR

SISTEMA DE INTERBLOQUEO DE CAJON

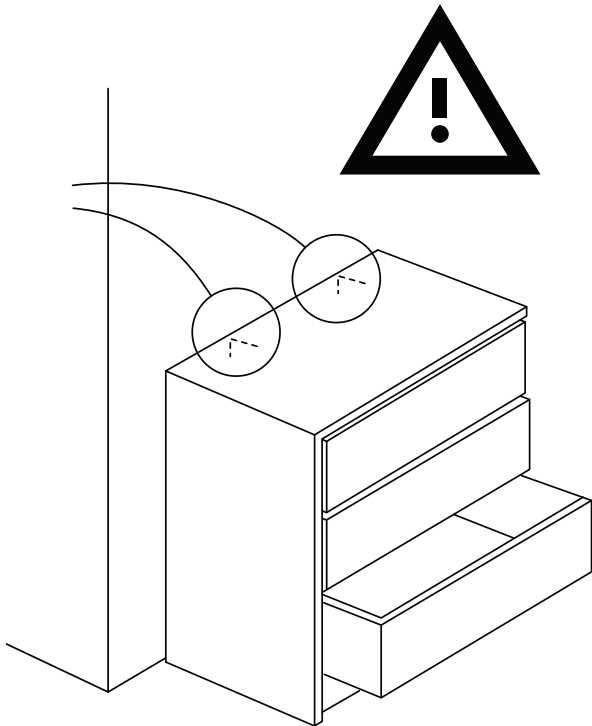

Never use the unit without the interlock system installed following the instructions

Ne jamais utiliser l'appareil sans le verrouillage installé en suivant les instructions

Nunca utilice la unidad sin el sistema de enclavamiento instalado siguiendo las instrucciones

This item features an interlock system that allows for the opening of only one drawer at a time, preventing the simultaneous opening of multiple drawer.

Cet article est doté d'un système de verrouillage qui permet l'ouverture d'un seul tiroir à la fois, empêchant l'ouverture simultanée de plusieurs tiroirs.

Este artículo cuenta con un sistema de bloqueo que permite la apertura de un solo cajón a la vez, evitando la apertura simultánea de varios cajones.

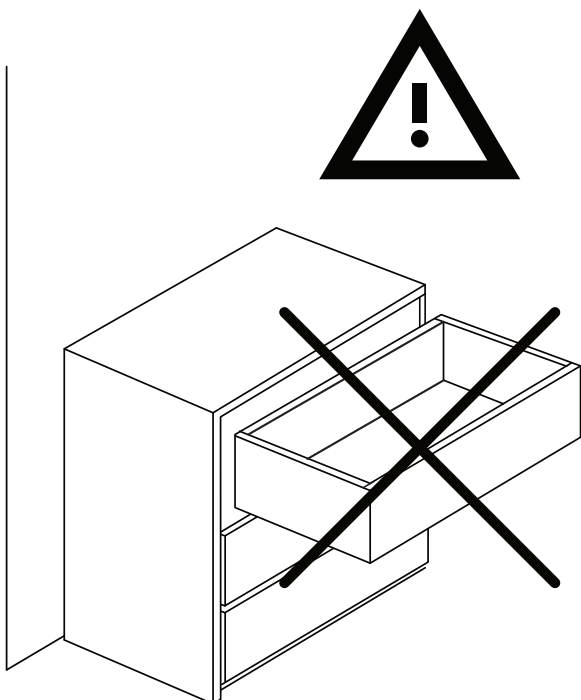

Do not defeat or remove the drawer interlock system. It is important stability and safety system.

Ne pas défaire ou retirer le système de verrouillage du tiroir; il s'agit d'un important système de stabilité et de sécurité.

No anule ni retire el sistema de bloqueo del cajón. Es importante el sistema de estabilidad y seguridad.

STEP 17

Start by assembling the bottom most drawer first and work upwards.

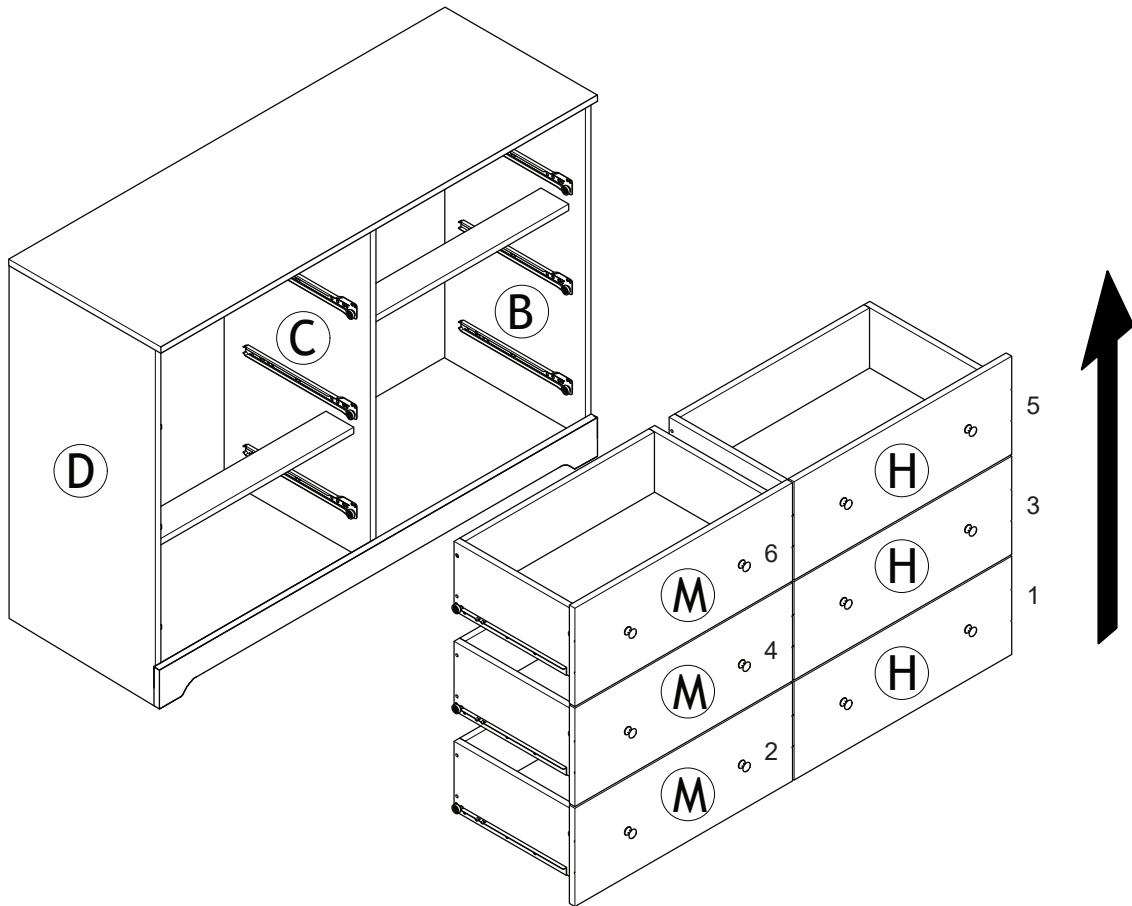

STEP 18

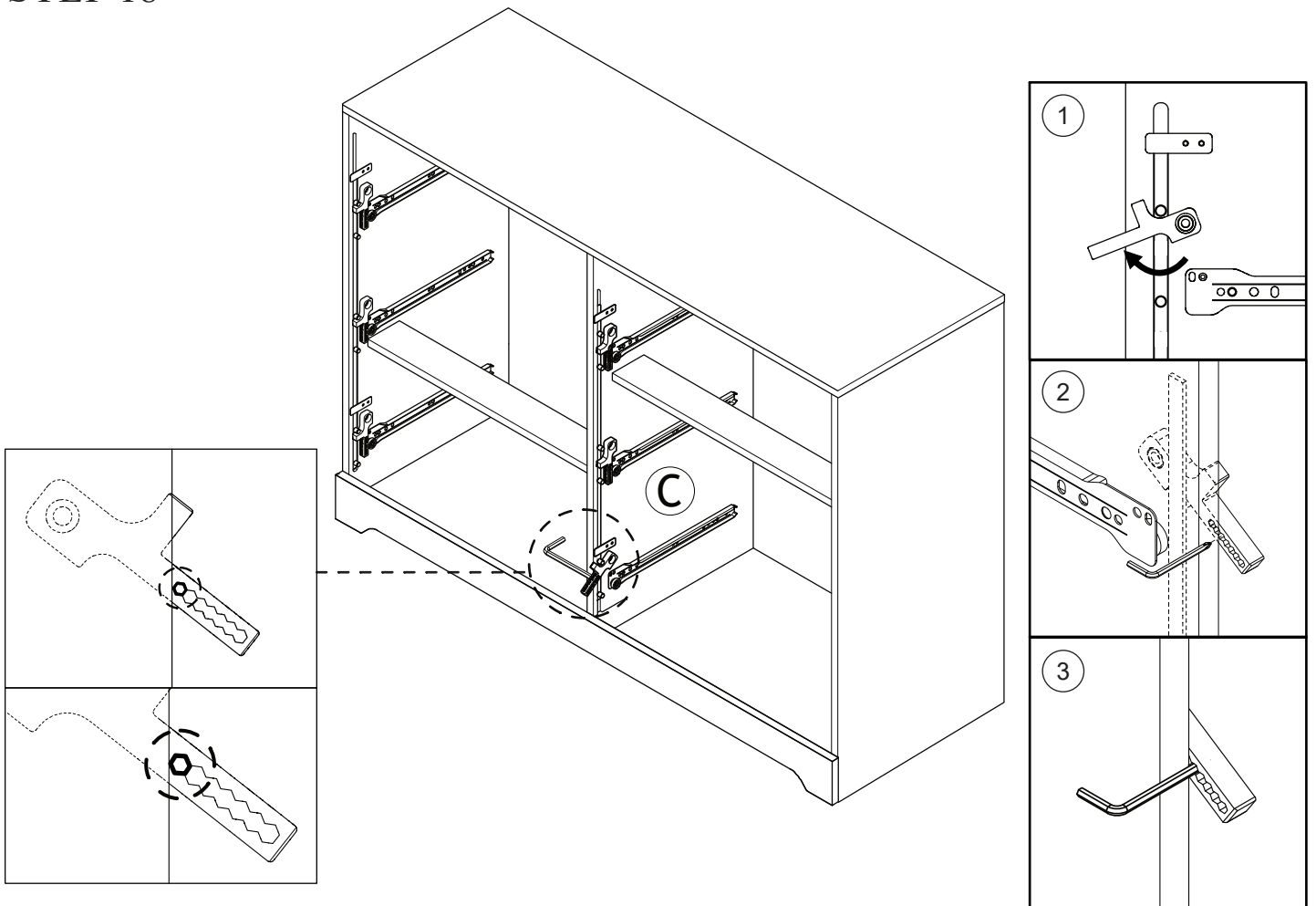

STEP 19

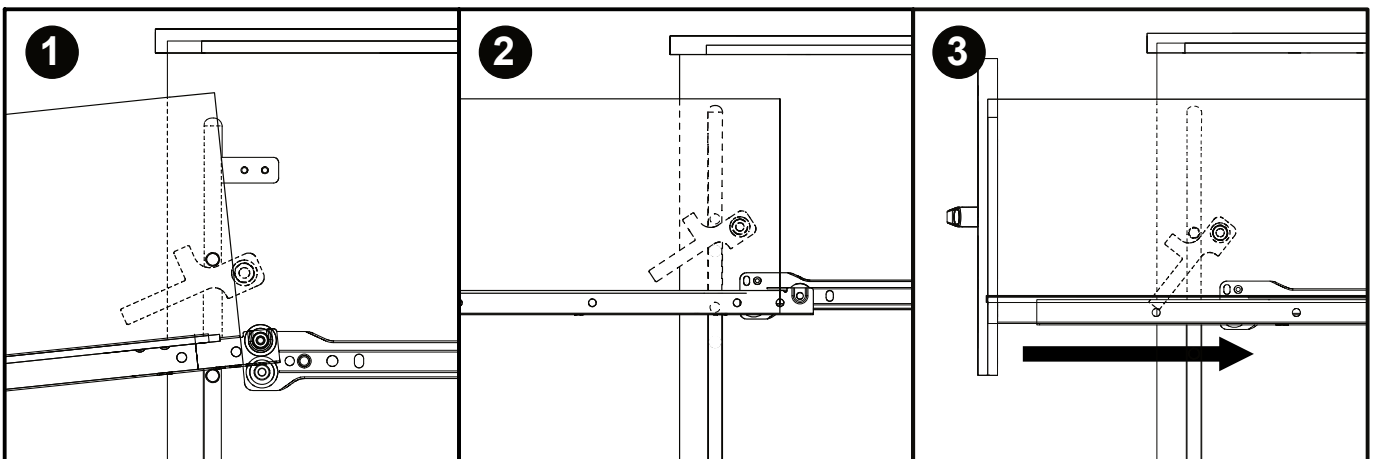
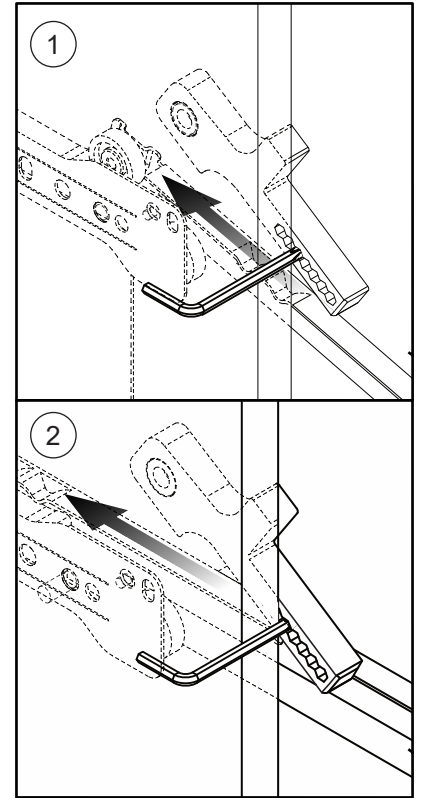
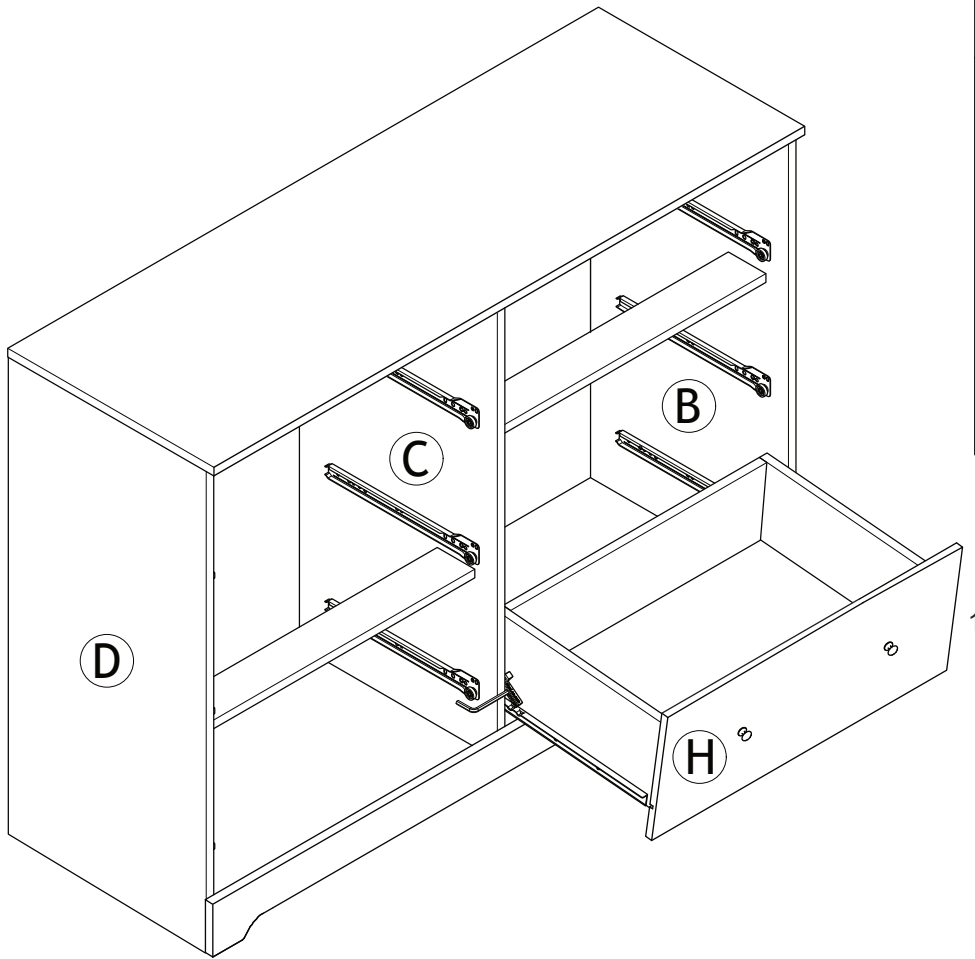

STEP 20

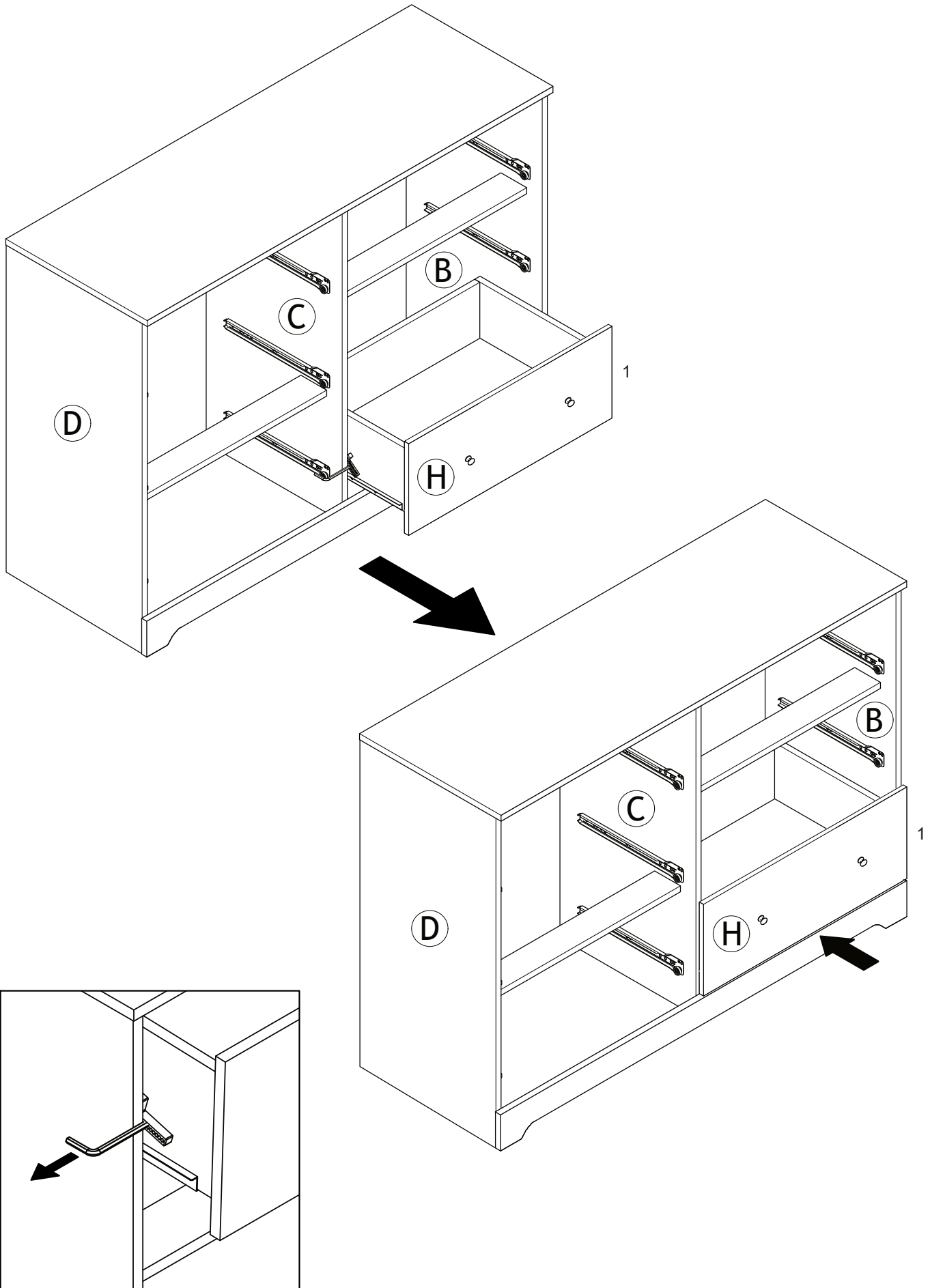

STEP 21

Repeat step 18 to 20 for each of the remaining drawer.

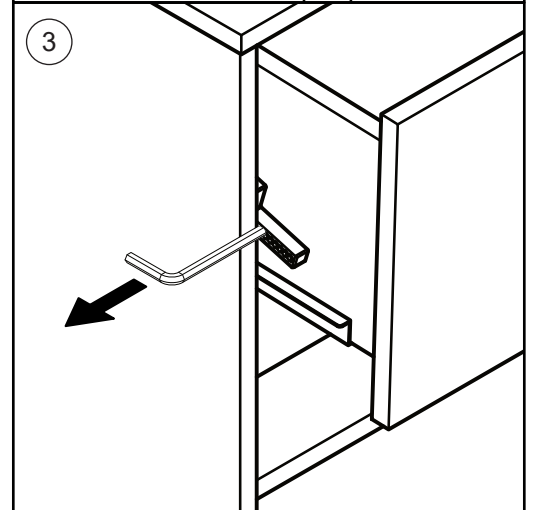
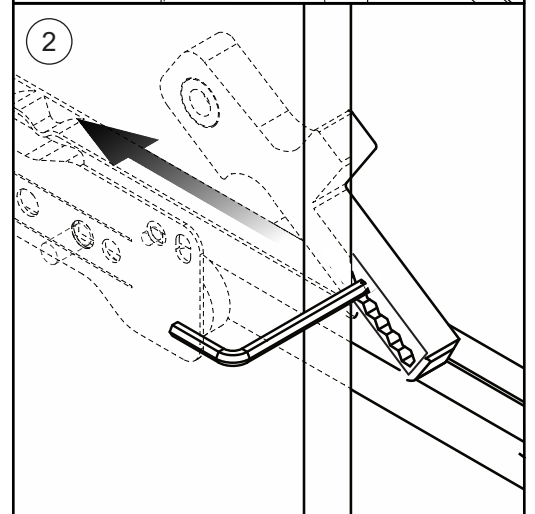
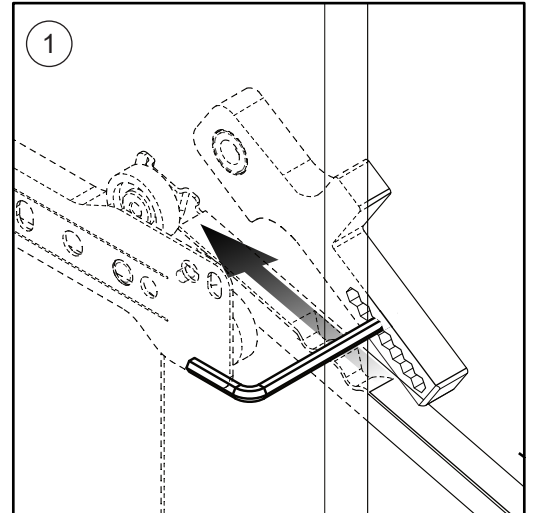
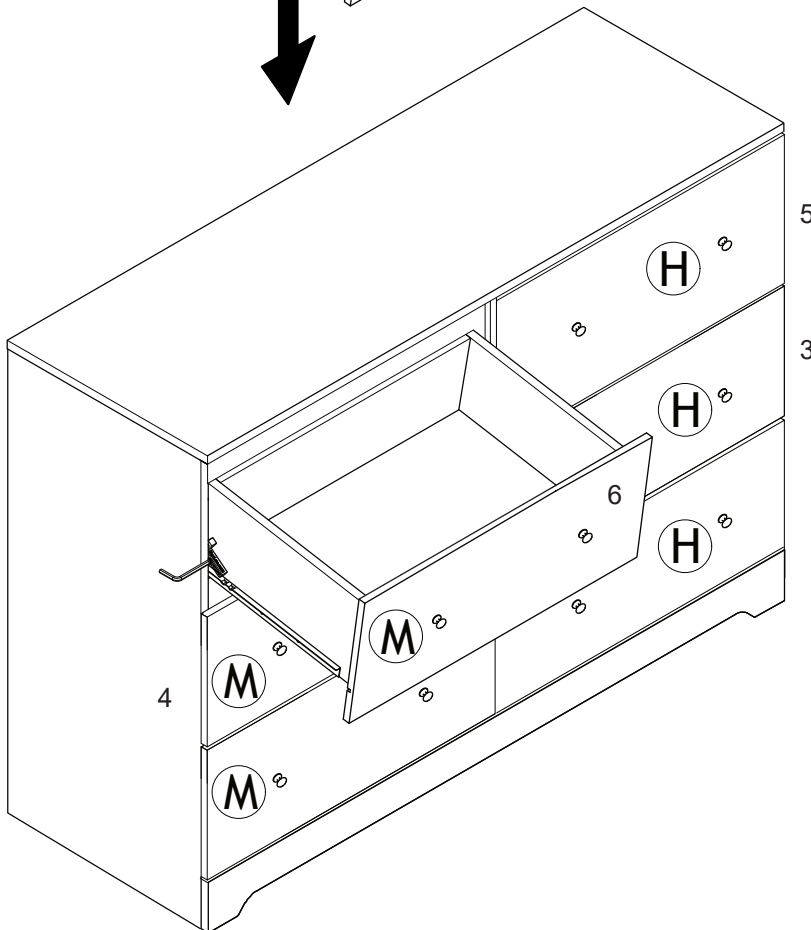
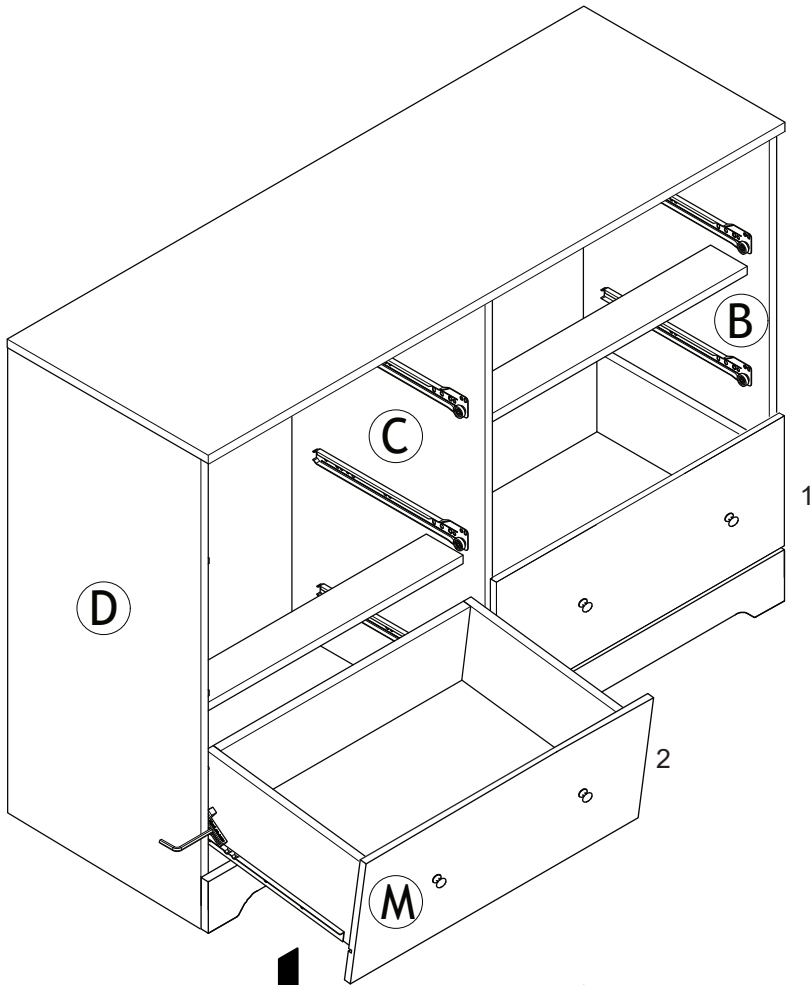

MAXIMUM LOADS CHARGES MAXIMALES / CARGA MAXIMA

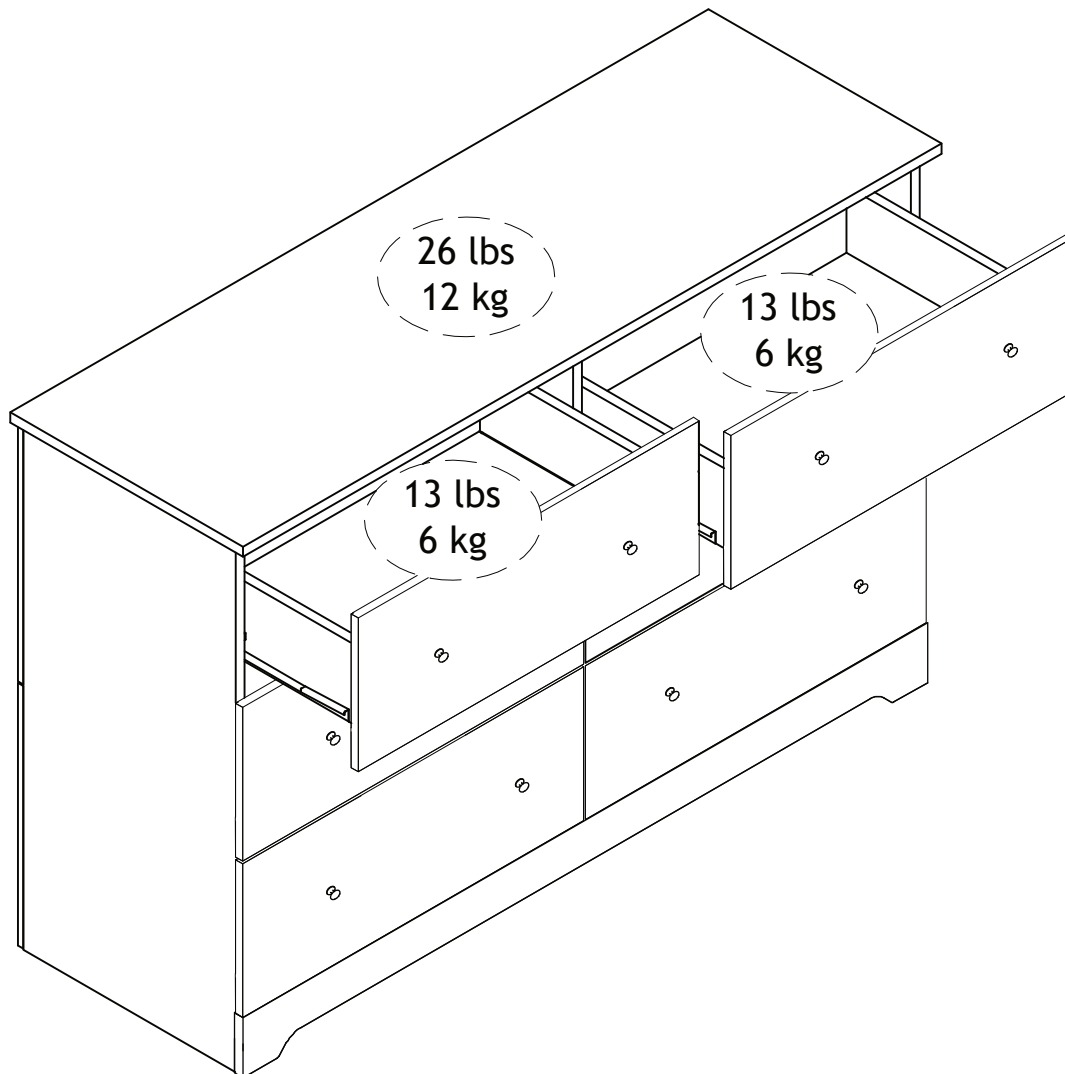

This product is designed to withstand the weight noted on the plan. We are not responsible for the breakage of parts or any injury caused by failure to comply with this recommendation.

Ce produit est conçu pour supporter le poids indiqué sur le plan. Nous ne sommes pas responsables de la casse de pièces ou toute blessure causée par le non-respect de cette recommandation.

Este producto está diseñado para soportar el peso indicado en el plano. No somos responsables de la rotura de piezas o cualquier lesión causada por el incumplimiento de esta recomendación.
