

OUTDOOR DINING TABLE

ASSEMBLY MANUAL

Guide of Manual

- Thanks for your choice. We will do our best to provide customer service for everyone.
- Please check to make sure all parts are included as stated when you unpack. If there are parts missing or wrong, please contact us, we will expeditiously provide reissue accessories, compensation or other services.
- Instruction should be read carefully. But the manual may not cover every detail of all possible situations and steps. Please contact us if further information and help are needed. We will respond in a timely manner.

Warning



- It's kindly advised to assemble this product on a carpeted floor to protect it from being scratched.
- Small parts are included. Please keep the product away from children while assembling. Do not let children play or jump on the product. Do not stand on the item or use as a step ladder.
- Prior to use, please check to see if there's any loosening screw or part. Make sure that each screw and part is correctly installed and securely fastened.
- Heat Resistance: The table can withstand temperatures up to 230°F (110°C). Avoid placing high-temperature objects (such as grills or hot pots) directly on the surface to prevent damage. Using heat-resistant mats is recommended.

Care and Maintenance

- Prior to use, please check to see if there's any loosening screw or part. Make sure that each screw and part is correctly installed and securely fastened.
- Use a soft, clean cloth that will not scratch the surface when dusting.
- This item could be cleaned with soap and water. Be sure to avoid harsh solvents and abrasives.
- Periodically (every 90 days) make sure the screws are fully tightened.

PARTS LIST

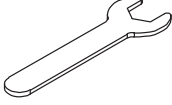
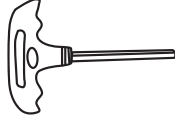



TOOLS REQUIRED

			
ALLEN WRENCH (PROVIDED)	OPEN END WRENCH (PROVIDED)	T HANDLE HEX KEY (PROVIDED)	POWER DRILL (NOT PROVIDED)



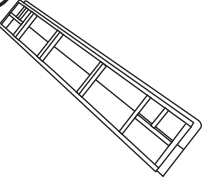
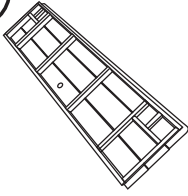





ASSEMBLY REQUIREMENT

	
2 PERSON ASSEMBLY	UP TO 15 MIN. ASSEMBLY



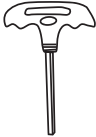

PARTS LIST

				
1PC	1PC	2PCS	4PCS	1PC

HARDWARE LIST

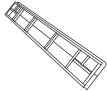
				
M6×70mm Bolt 12PCS	M6×60mm Bolt 6PCS	M6×65mm Bolt 8PCS	M6×50mm Bolt 4PCS	M6 Washer 18 PCS
				
M6 Nut 18PCS	Open End Wrench 1PC	Allen Wrench 1PC	T Handle Hex Key 1PC	



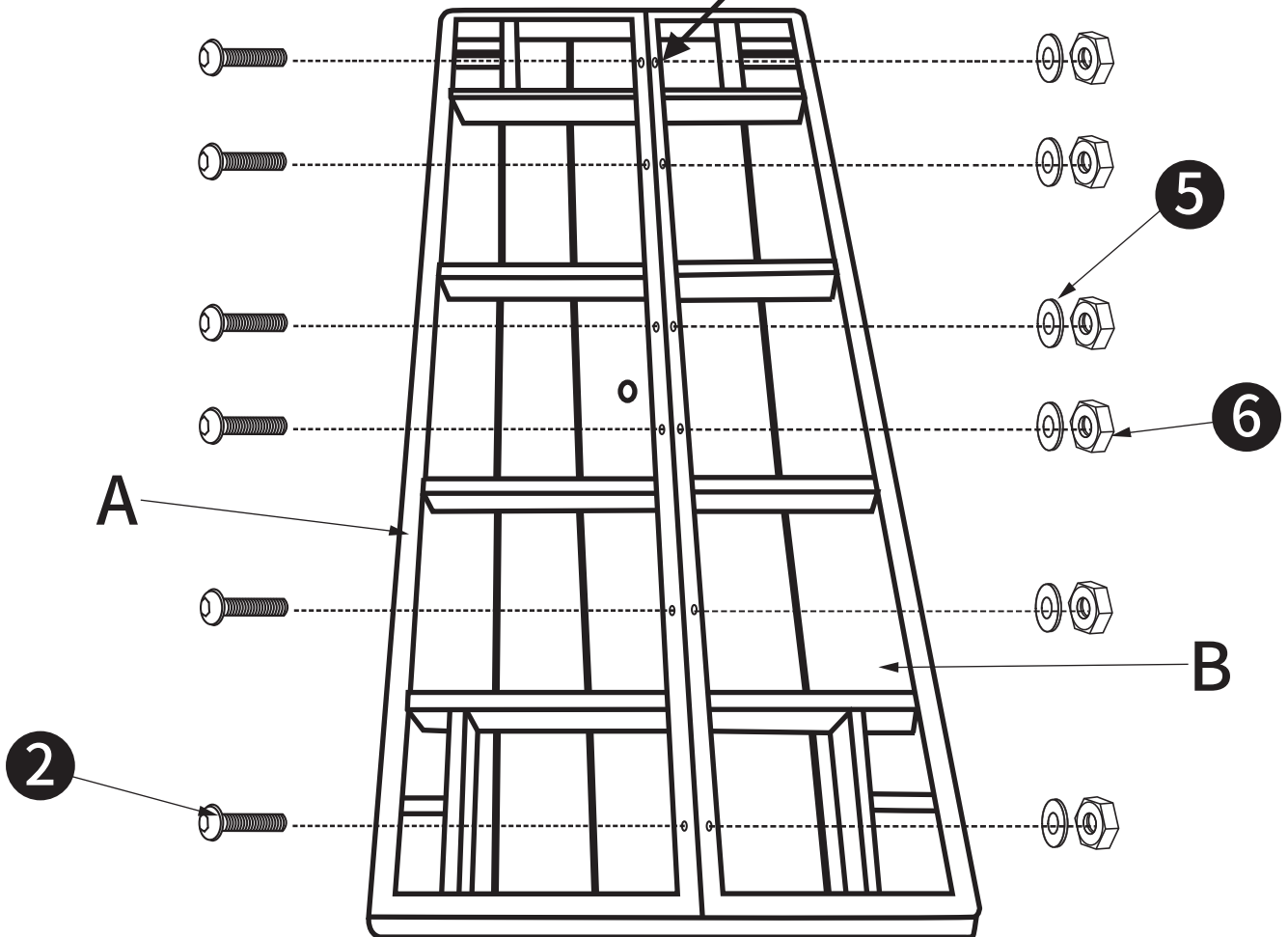
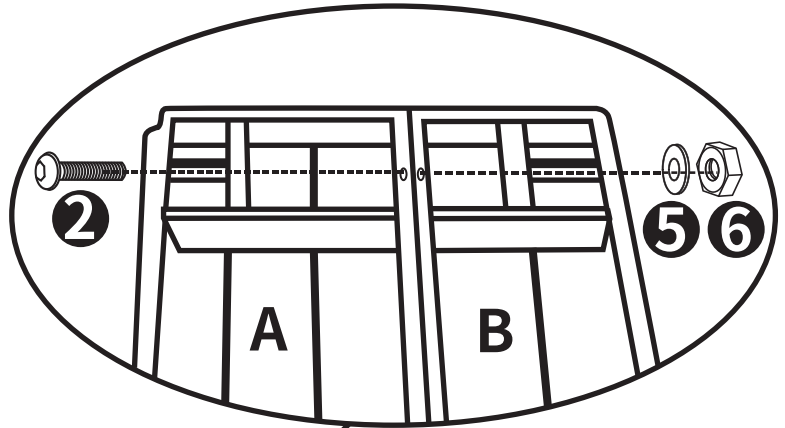

Step 1 Connect the tabletop(A) and tabletop(B) with 6 PCS screws(2), 6 PCS washers(5) and 6 PCS nuts (6)

A		1PC
B		1PC
2		6PCS
5		6PCS
6		6PCS



Note: Please use the screw from panel B to panel A, otherwise, assembly will be somewhat difficult if done in reverse.

Step 2 Connect 4 legs(D) to the tabletop with 12 PCS screws(1), 12 PCS washers(5) and 12 PCS nuts(6).

D		4PCS
1		12PCS
5		12PCS
6		12PCS

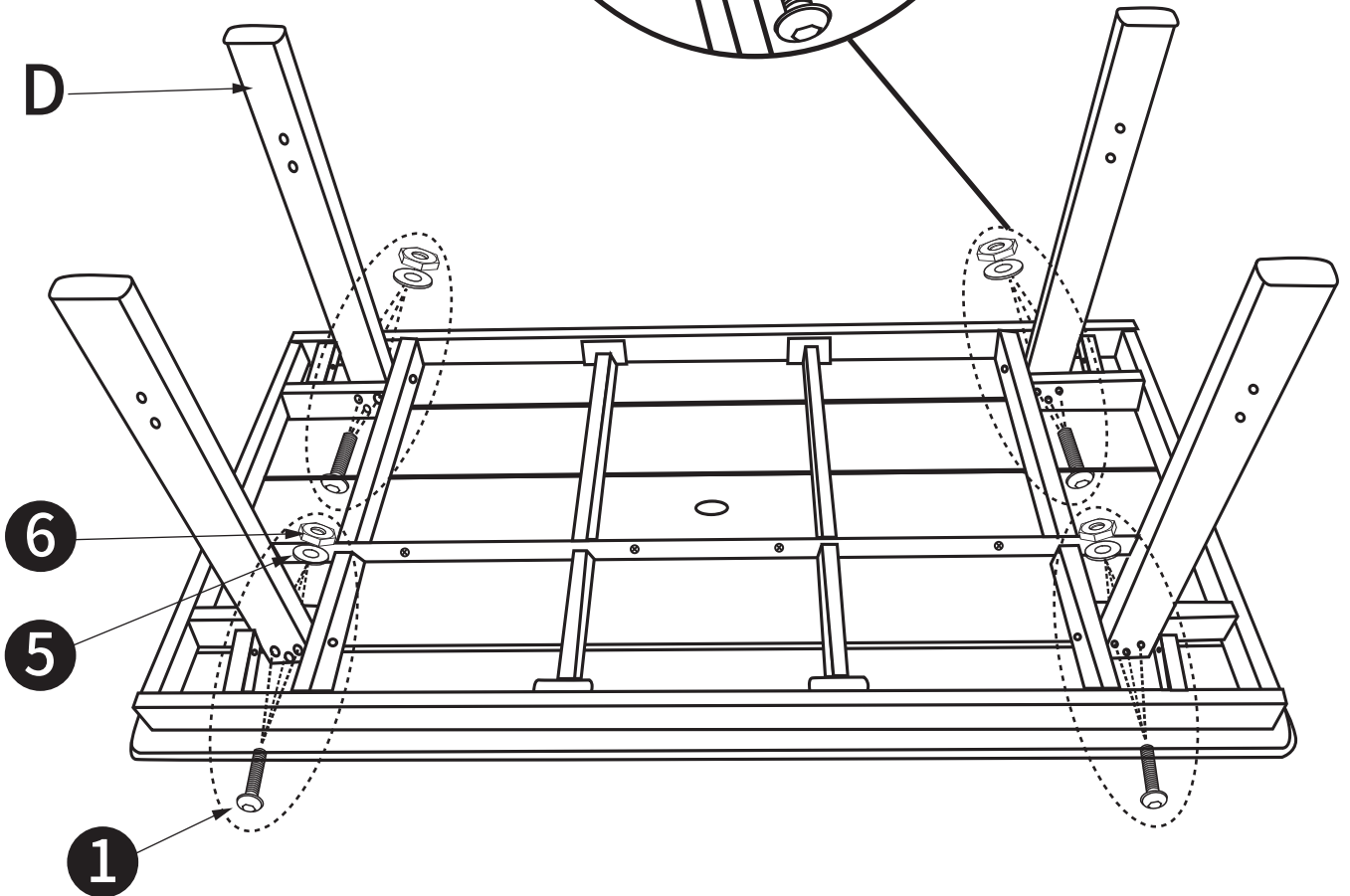
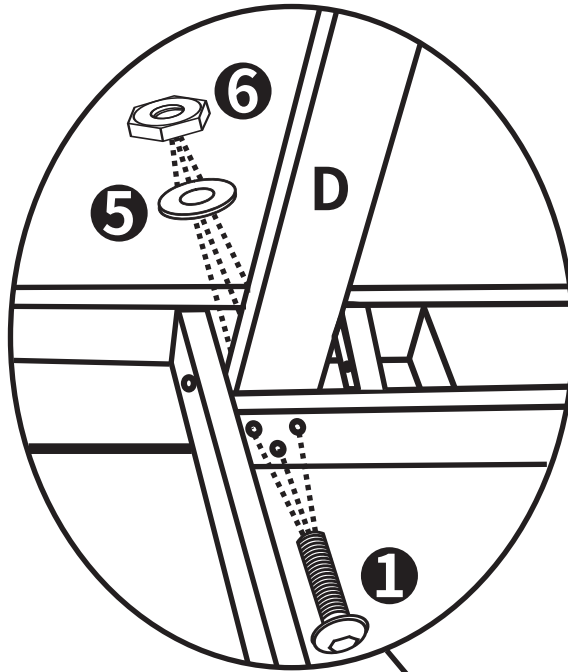

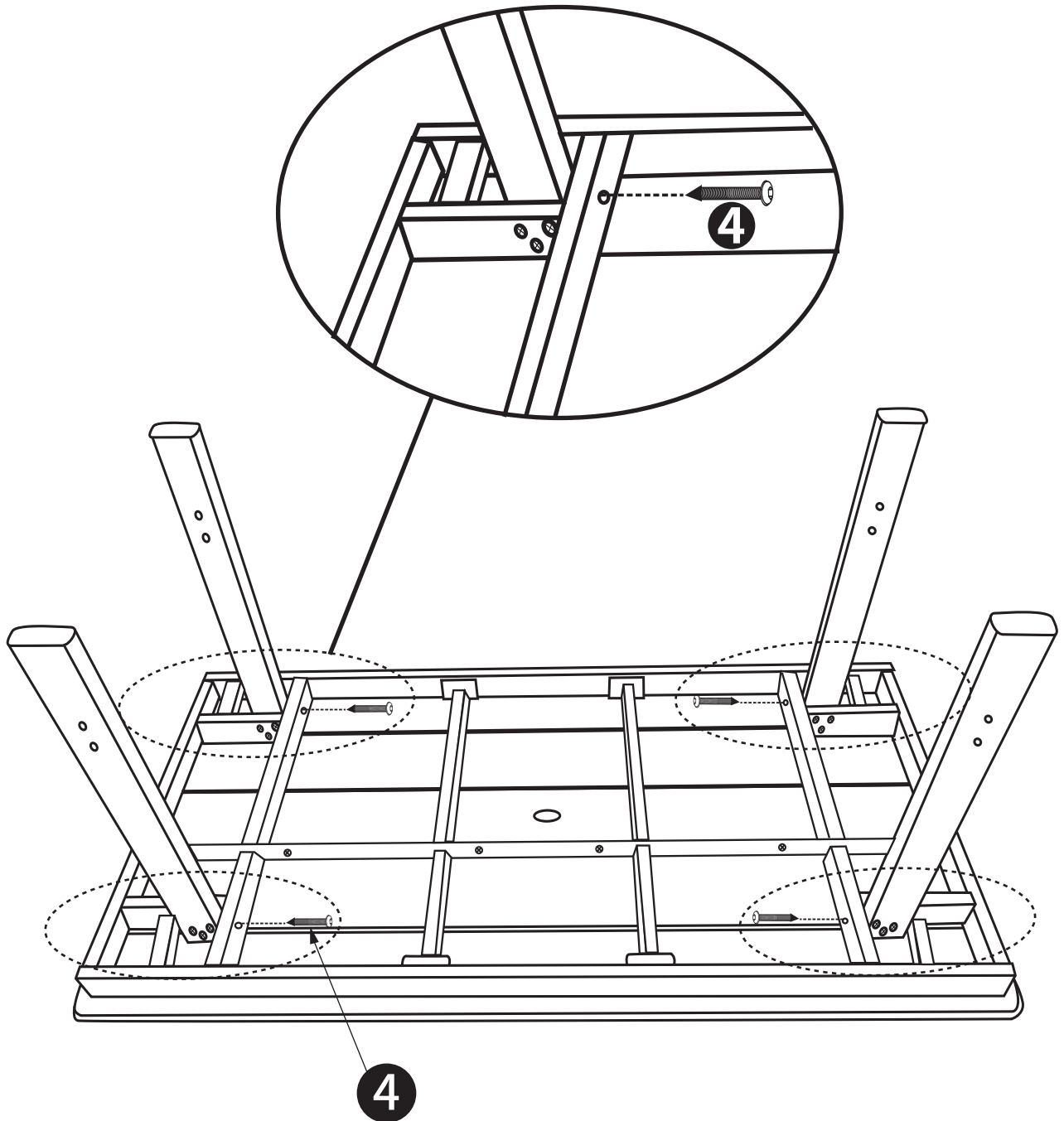

Step 3 Fix 4 legs to the tabletop with 4 PCS screws(4).

4		4PCS
---	---	------



Step 4 Connect 2 bars(C) to the legs with 8 PCS screws(3).

C		2PCS
3		8PCS

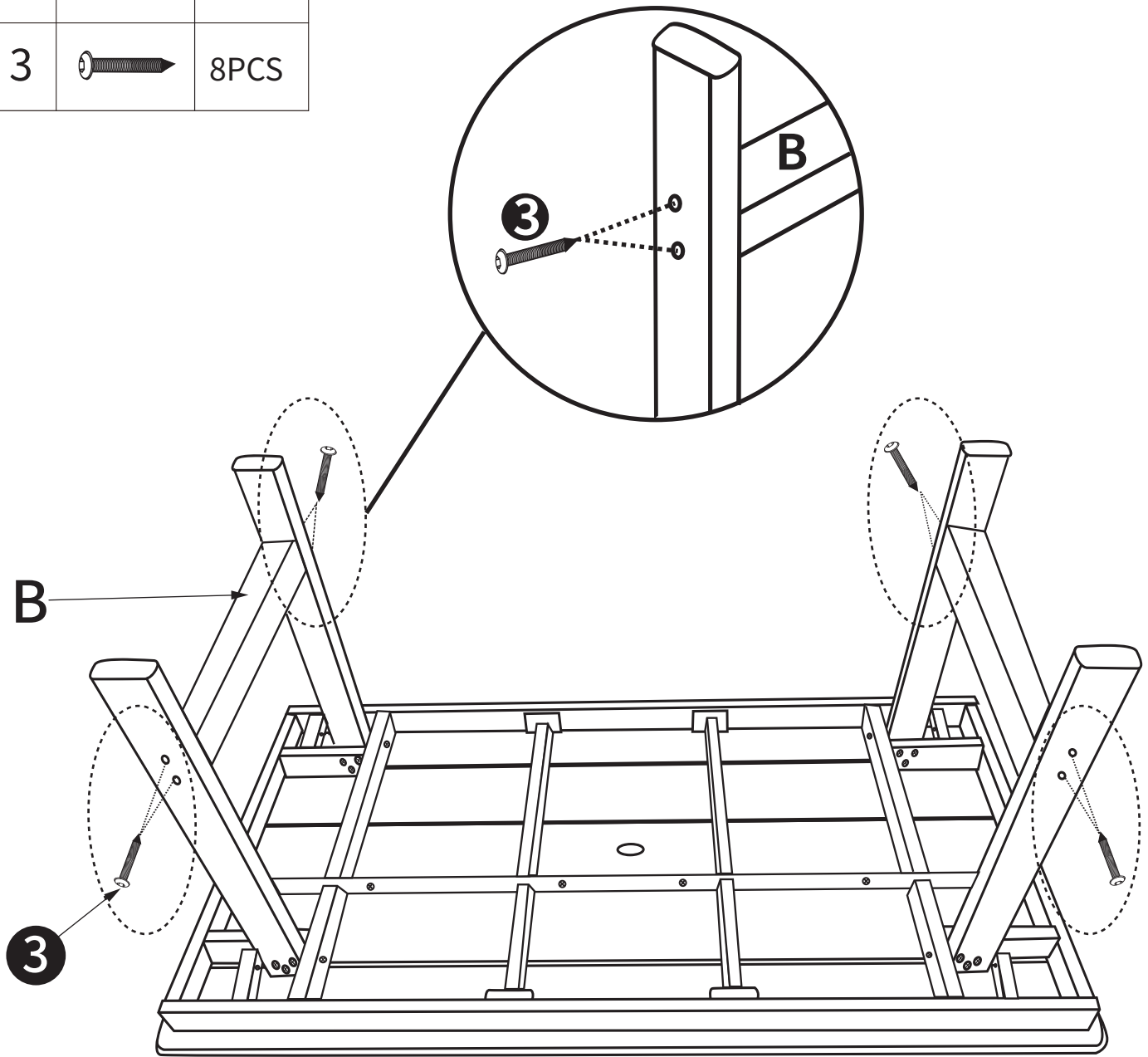

Step 5 Assembling the cover(E) of the umbrella hole.

E		1PC
---	---	-----

