

ASSEMBLY INSTRUCTIONS

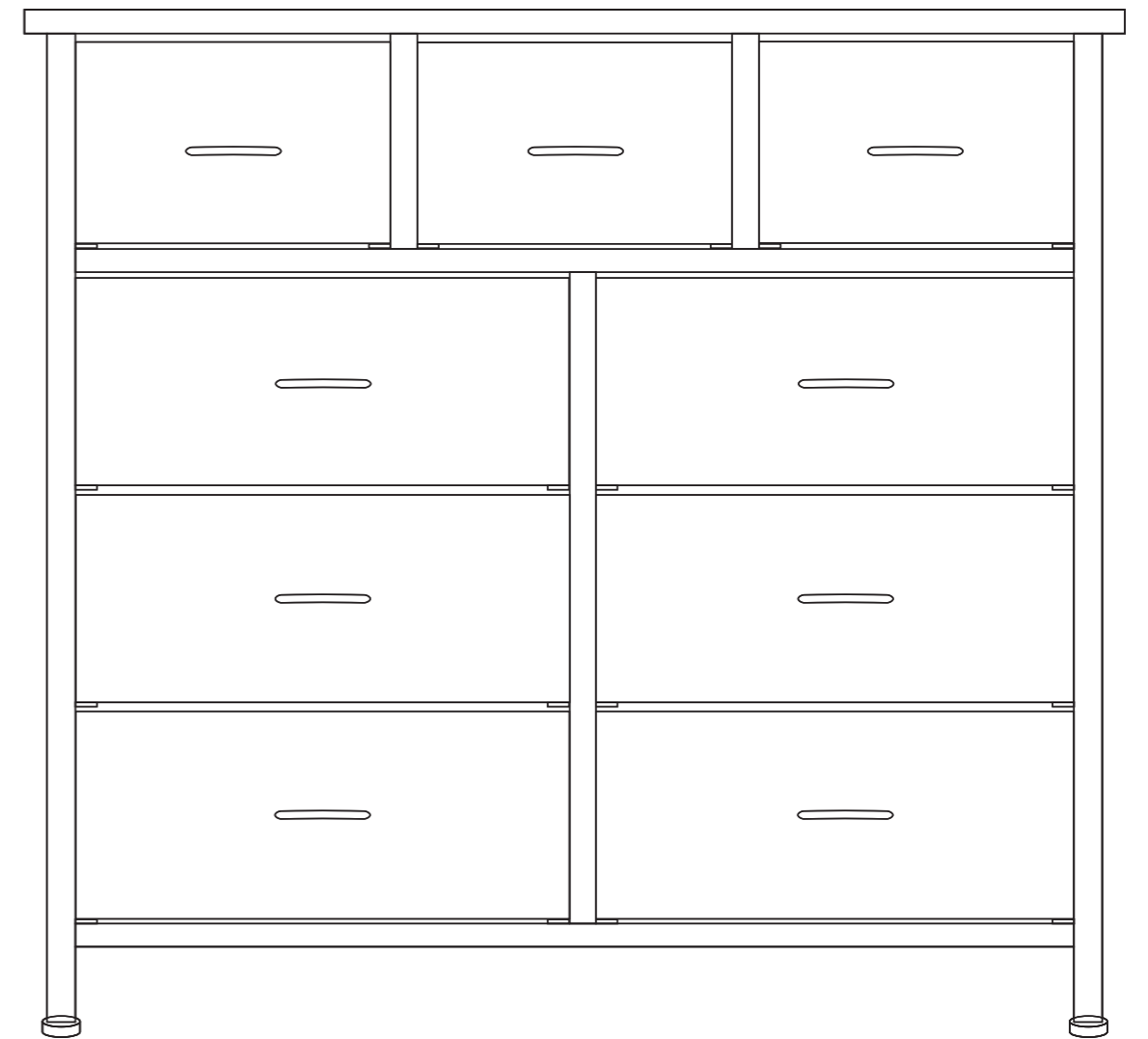

9-DRAWER STORAGE CHEST





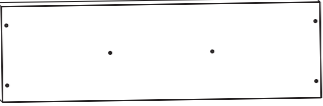
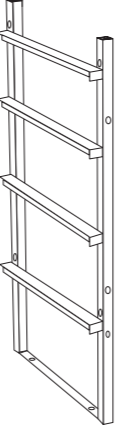
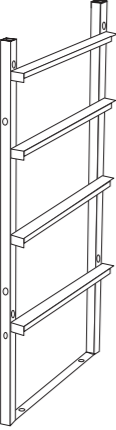
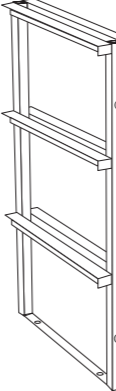
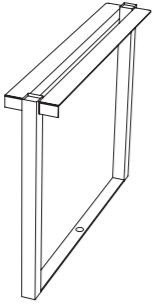
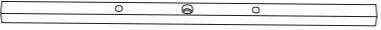

ASSEMBLY INSTRUCTIONS

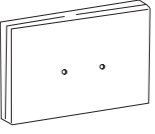
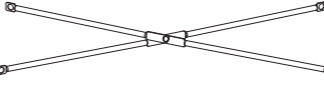
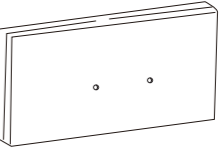
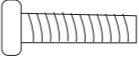
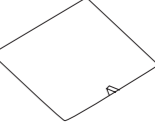

Attention: Do not tighten the screws until you have complete setup assembly. Please be aware that the drawer storage towers are lightweight, and pulling them down could be dangerous, especially when children are playing and chasing each other around the drawers.

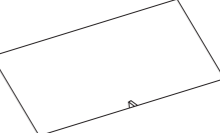
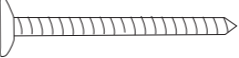
Item no.	Reference Image	Qty.	Item no.	Reference Image	Qty.
A		X1	D		X1
B		X1	E		X1
C		X2	F		X2

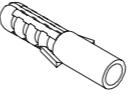
ASSEMBLY INSTRUCTIONS

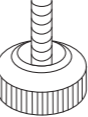
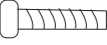
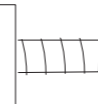
Item no.	Reference Image	Qty.	Item no.	Reference Image	Qty.
G		X2	O		X3
H		X2	P		X6
I	 M6 X 25mm	X16	Q		X3
J	 M6 X 10mm	X6	R		X6
K		X2	S		X9
L		X2	T		X1
M		X4	U	 M5 X 15mm	X6
N		X18			

ASSEMBLY INSTRUCTIONS

ASSEMBLY INSTRUCTIONS

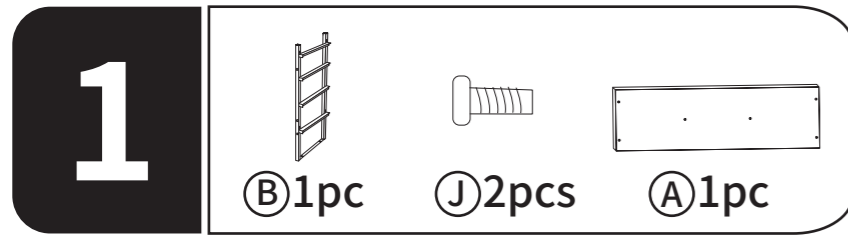

Please make sure that the iron frames are placed in the correct position and facing the correct direction.

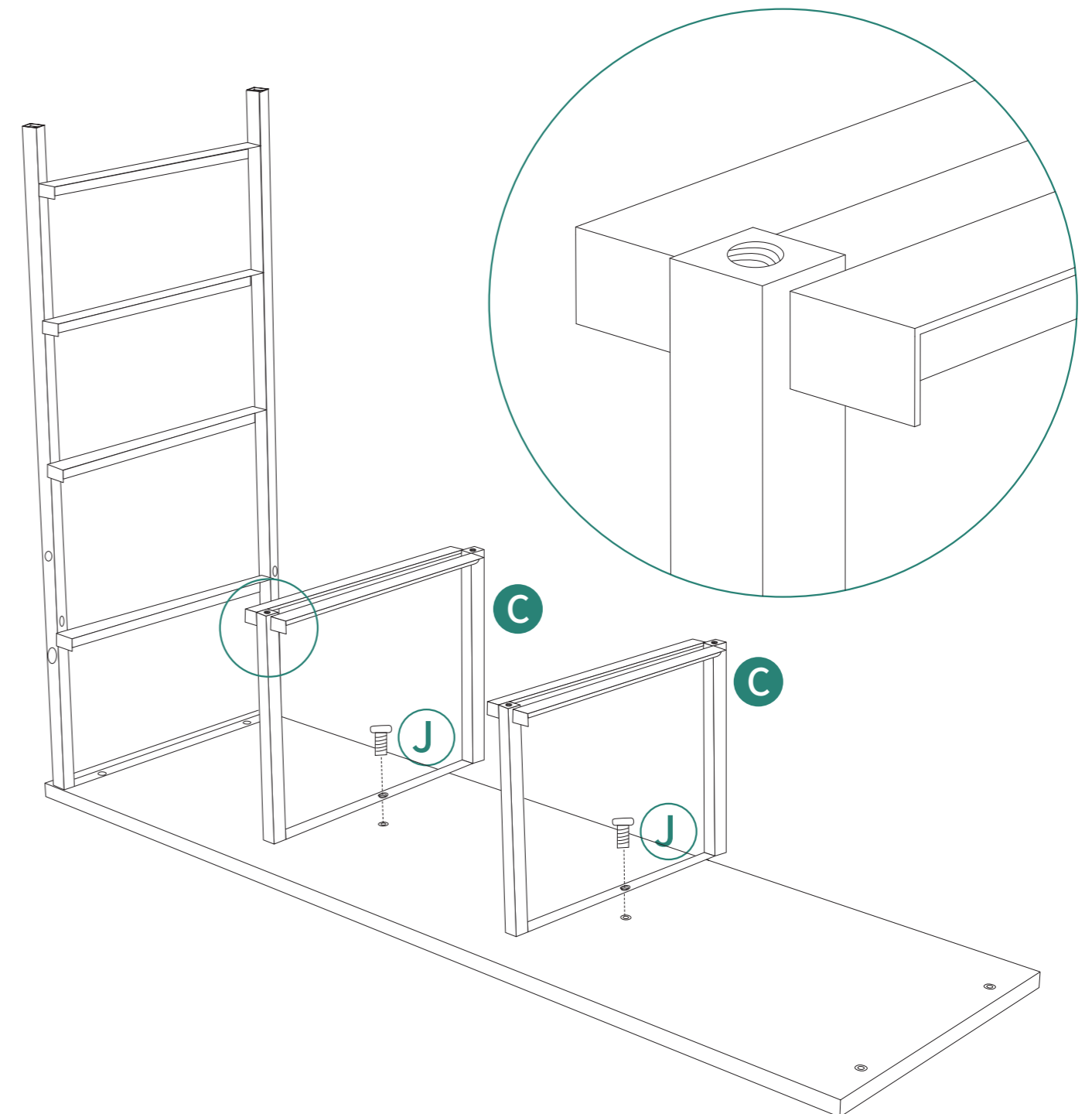
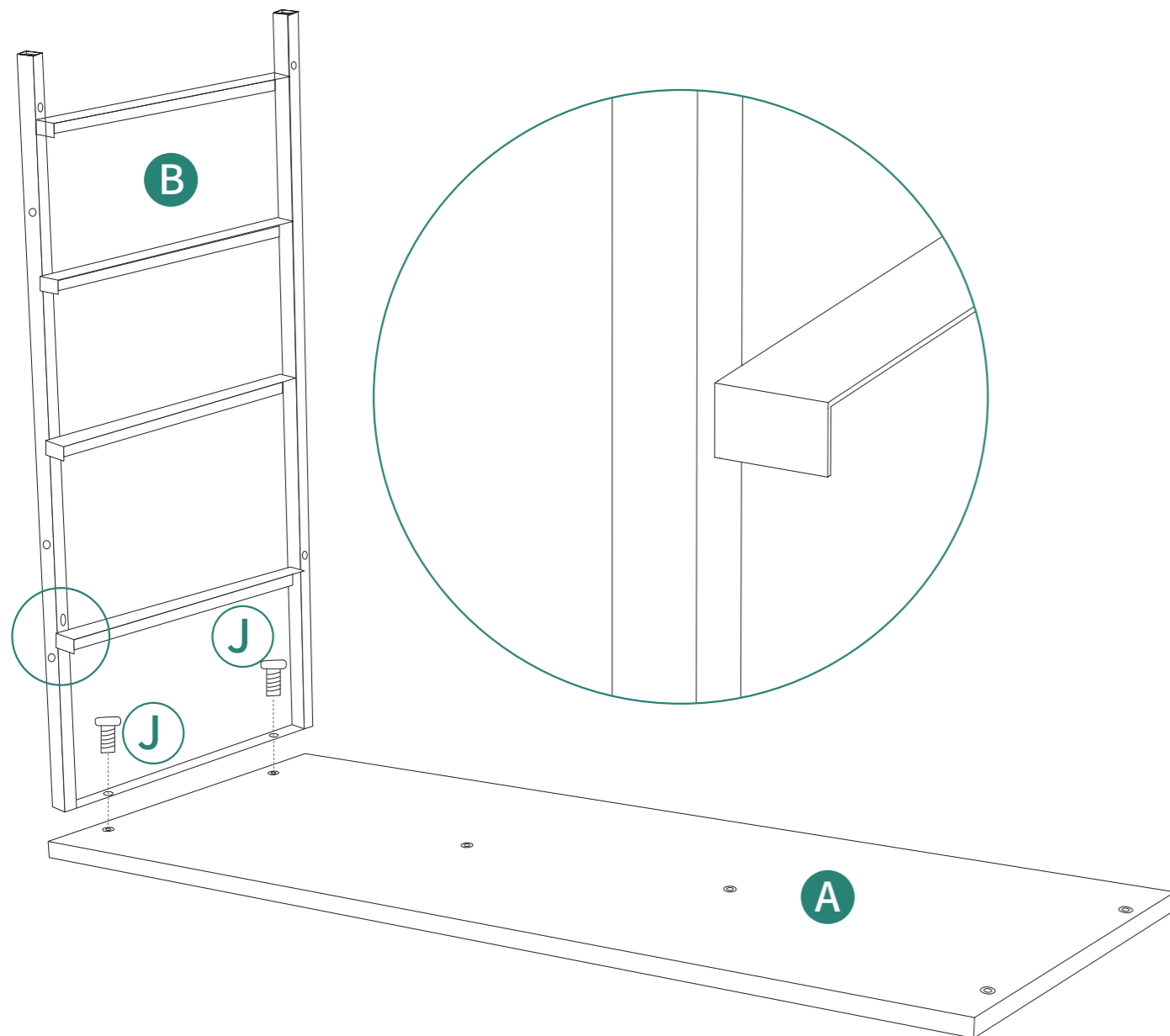
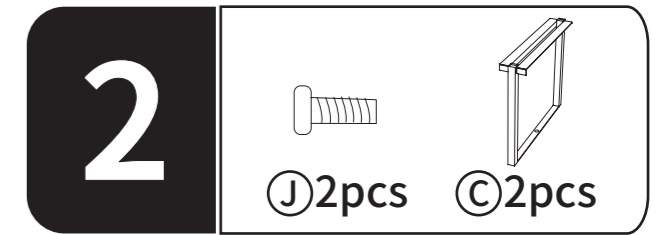

ASSEMBLY INSTRUCTIONS

ASSEMBLY INSTRUCTIONS

3

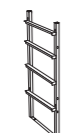

ⓓ 1pc



ⓙ 2pcs

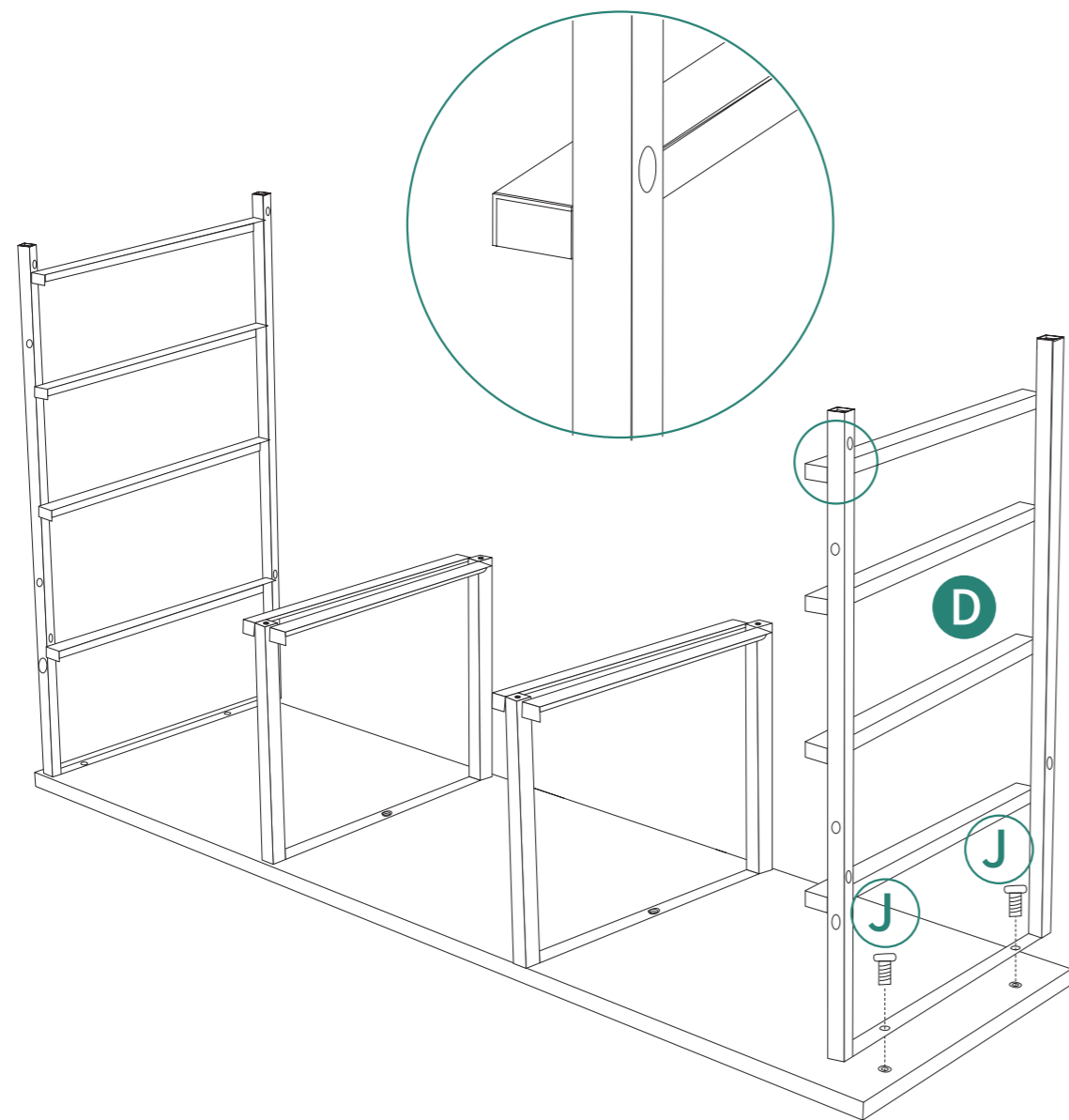

5

4



ⓕ 2pcs

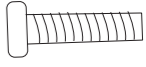

Ⓢ 8pcs

Attention: Confirm the direction Part F should be facing during assembly.
As shown in below picture, Part F has two sides with mounting holes
- the side with a small mounting hole in the center and two bigger adjacent holes
should be facing upward.

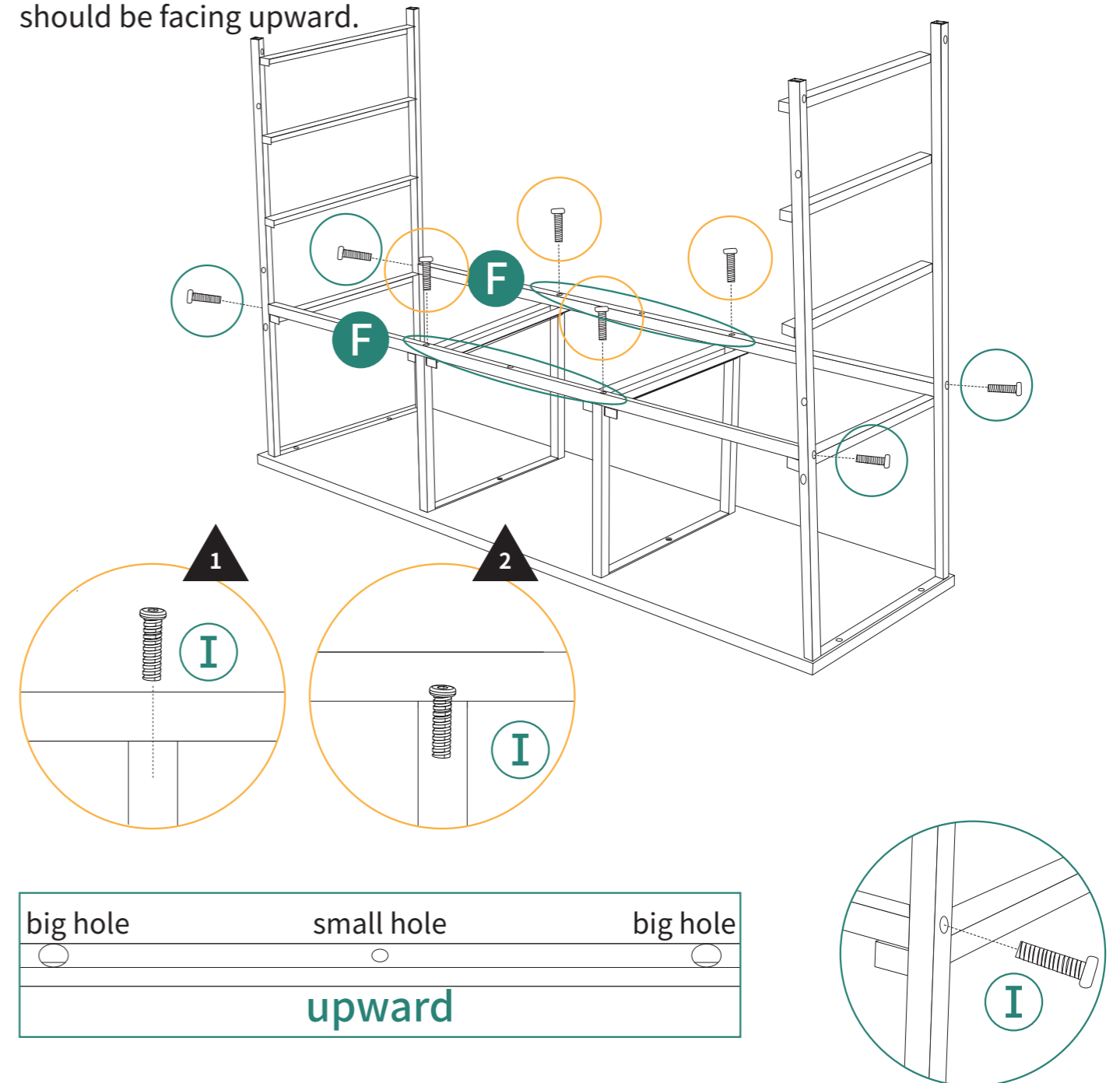

6

ASSEMBLY INSTRUCTIONS

ASSEMBLY INSTRUCTIONS

5

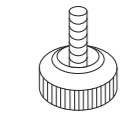

M 4pcs

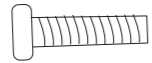

I 8pcs



G 2pcs



E 1pc

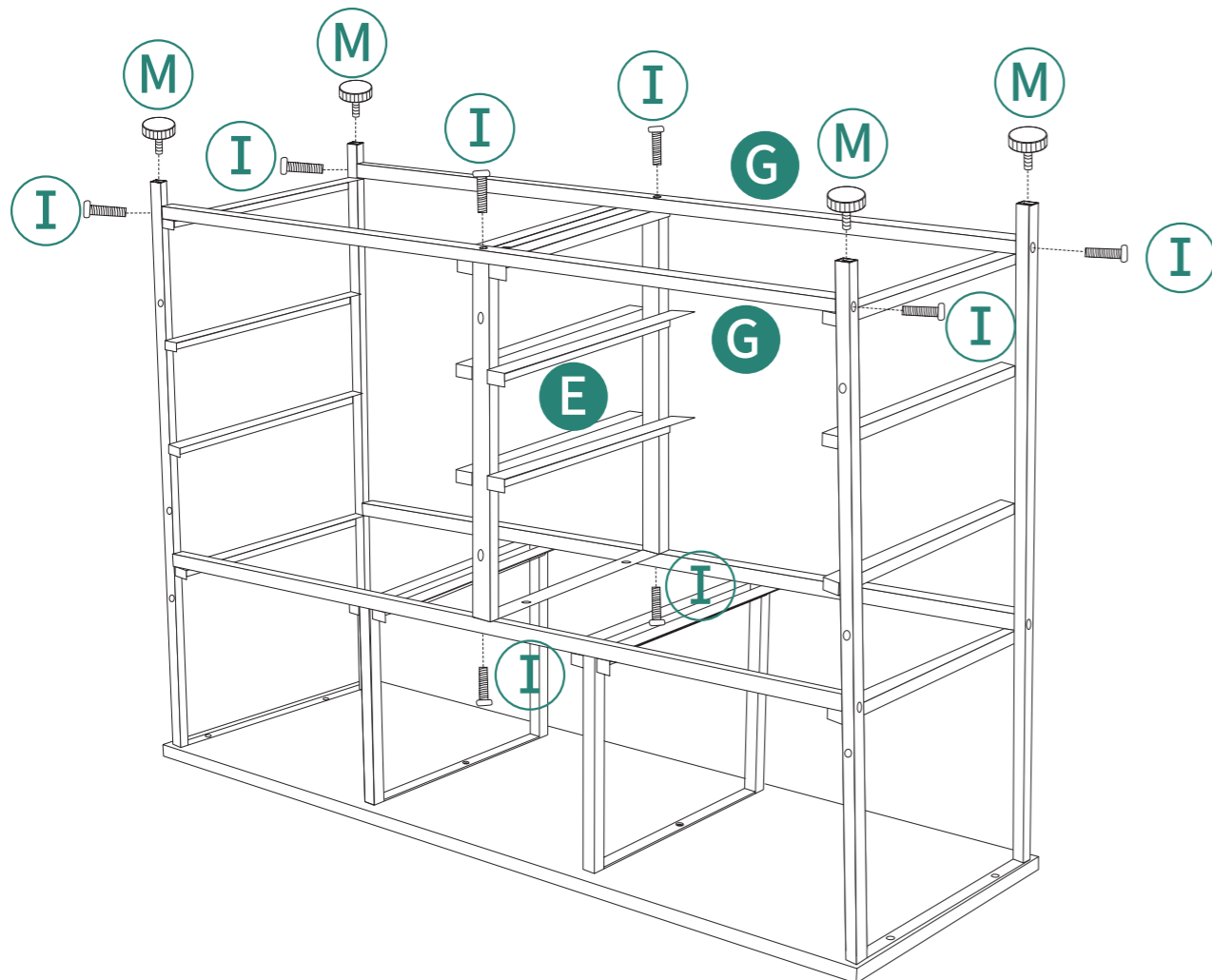

6

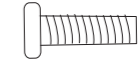

U 6pcs



H 2pcs

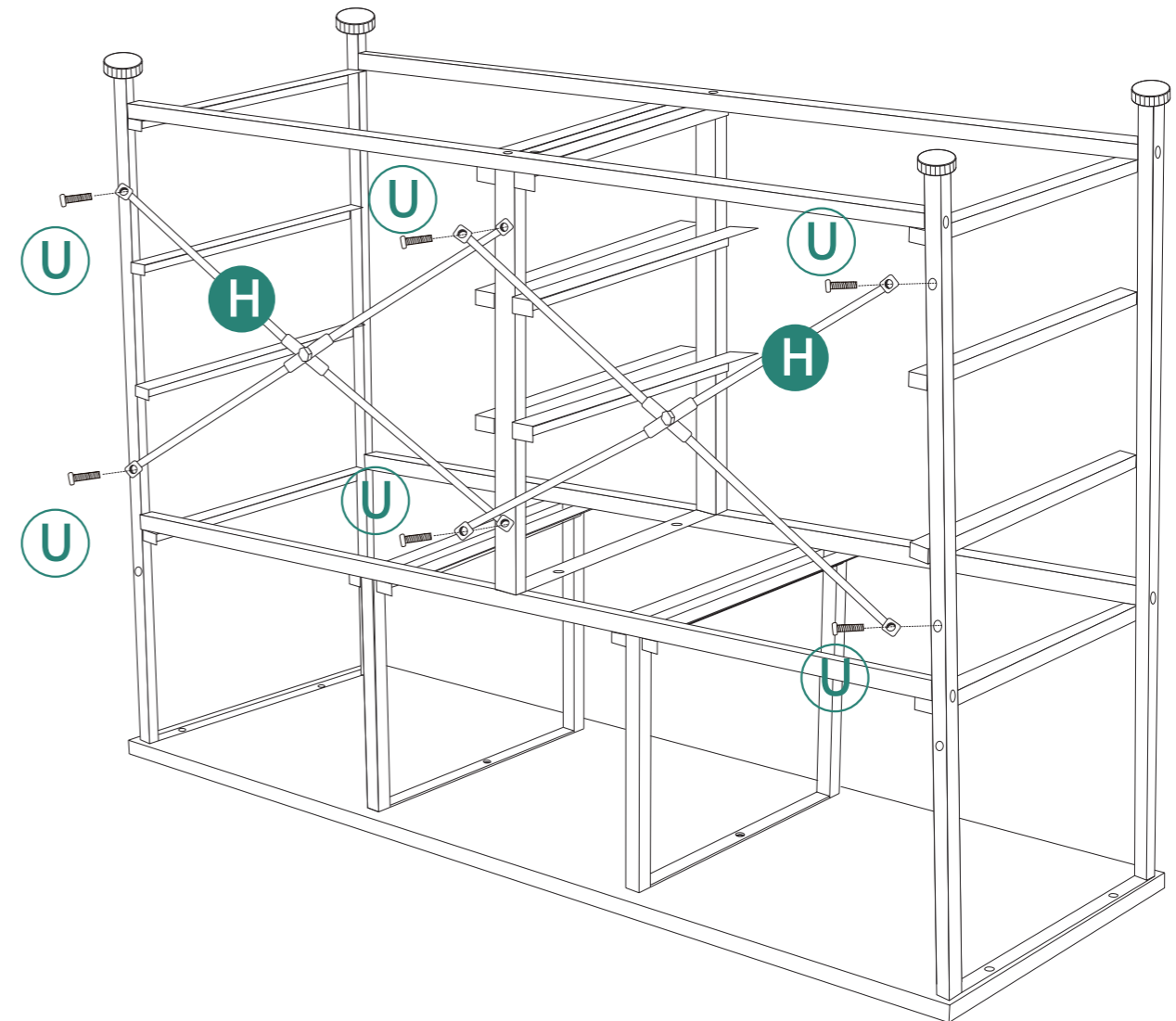

ASSEMBLY INSTRUCTIONS

ASSEMBLY INSTRUCTIONS

8

Ⓚ2pcs Ⓛ2pcs

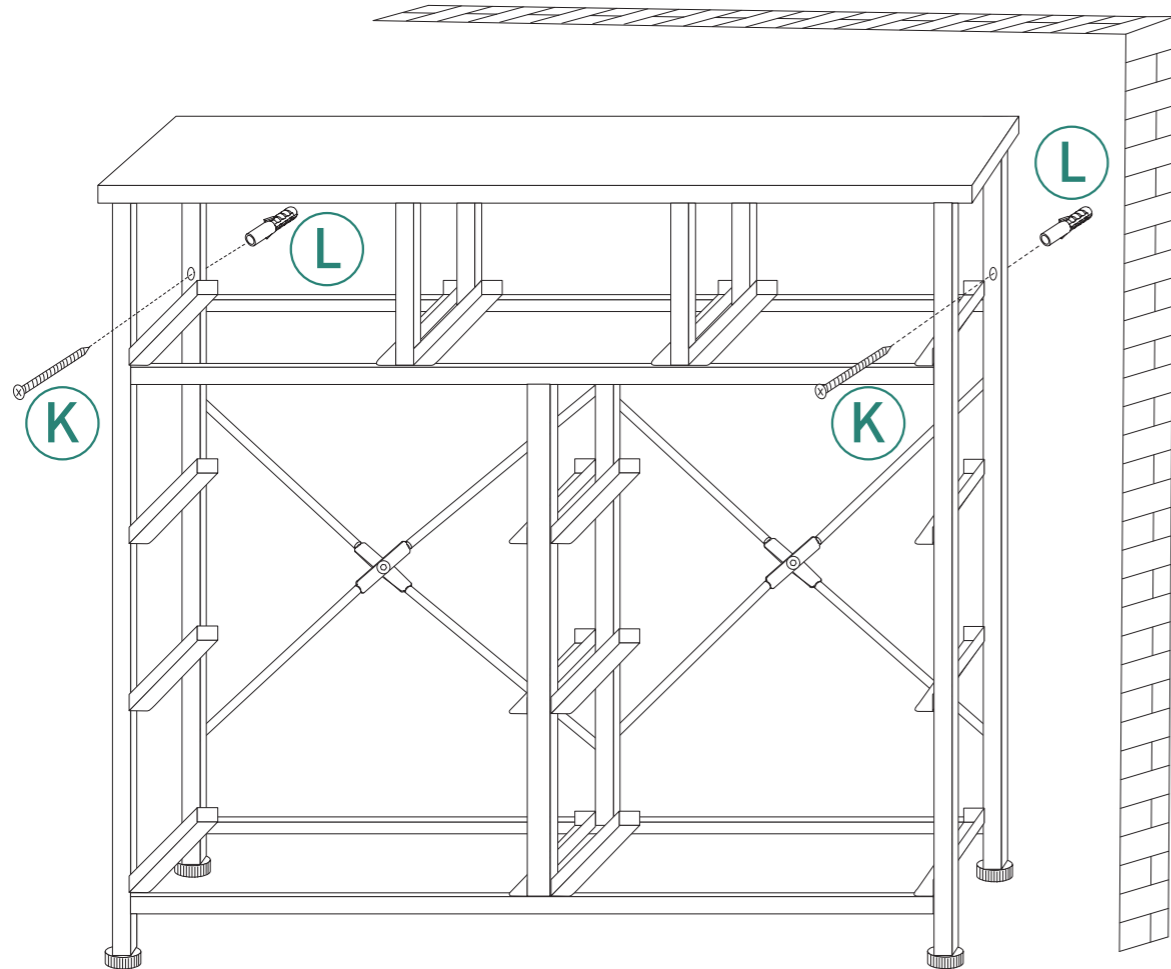
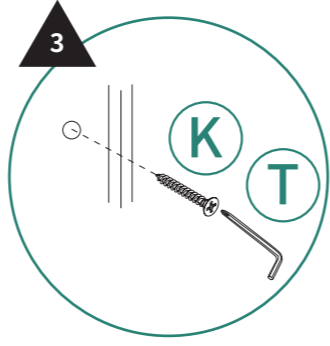
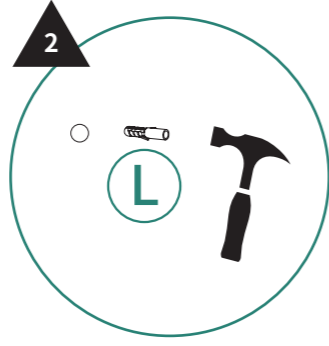
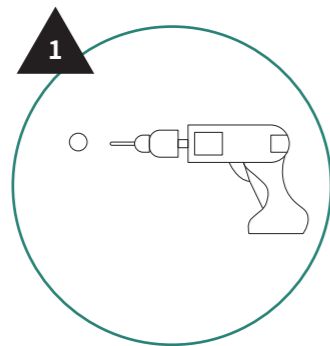
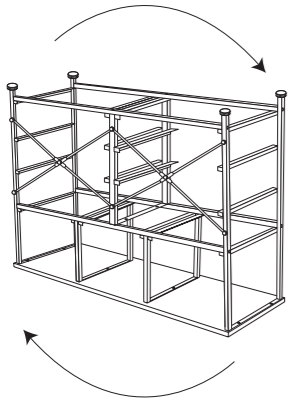

9
X3

ⓐ3pcs

ⓑ3pcs

ⓒ6pcs

ⓓ3pcs

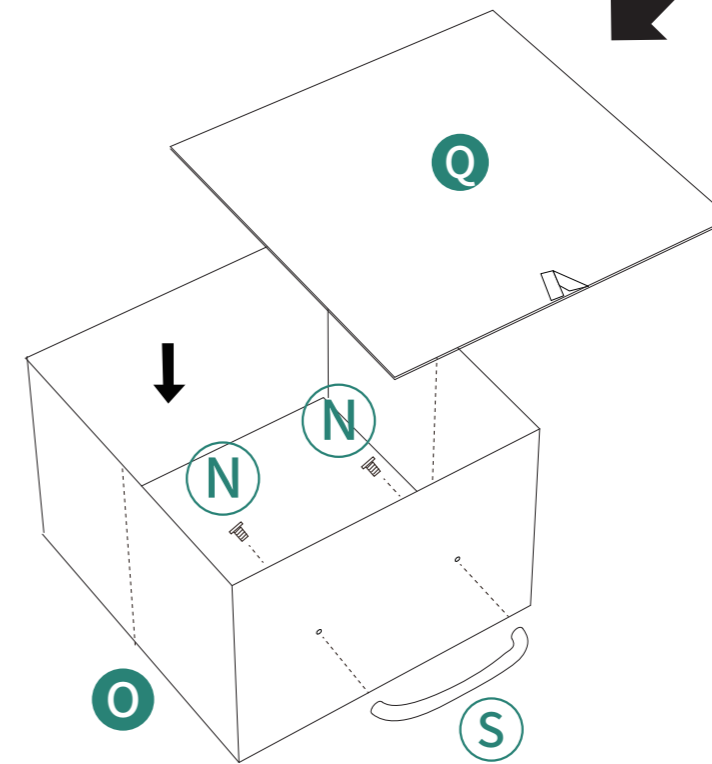
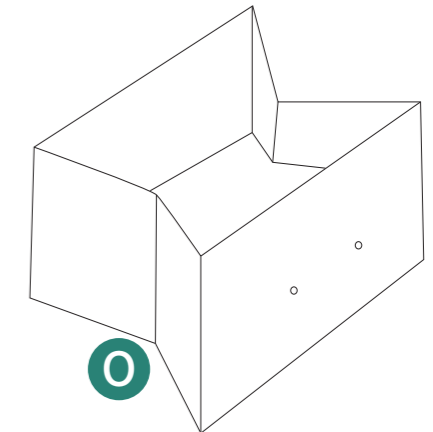
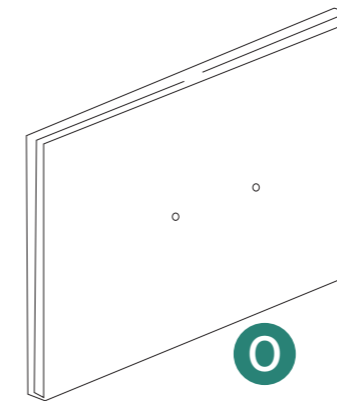

10
X6

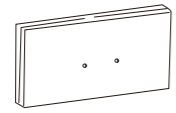

Ⓟ6pcs

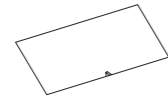

Ⓡ6pcs

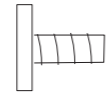

Ⓝ12pcs



Ⓢ6pcs

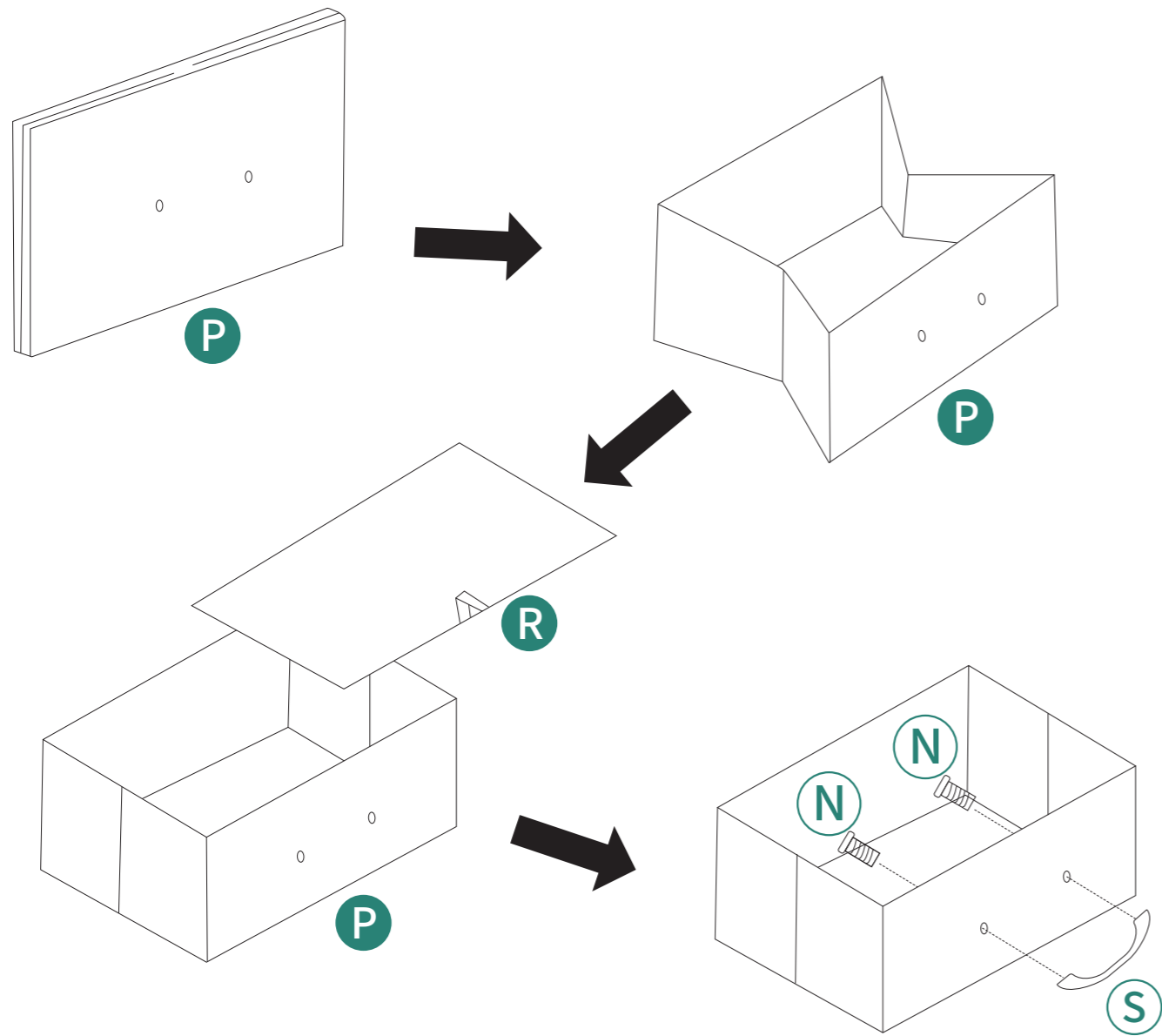

11

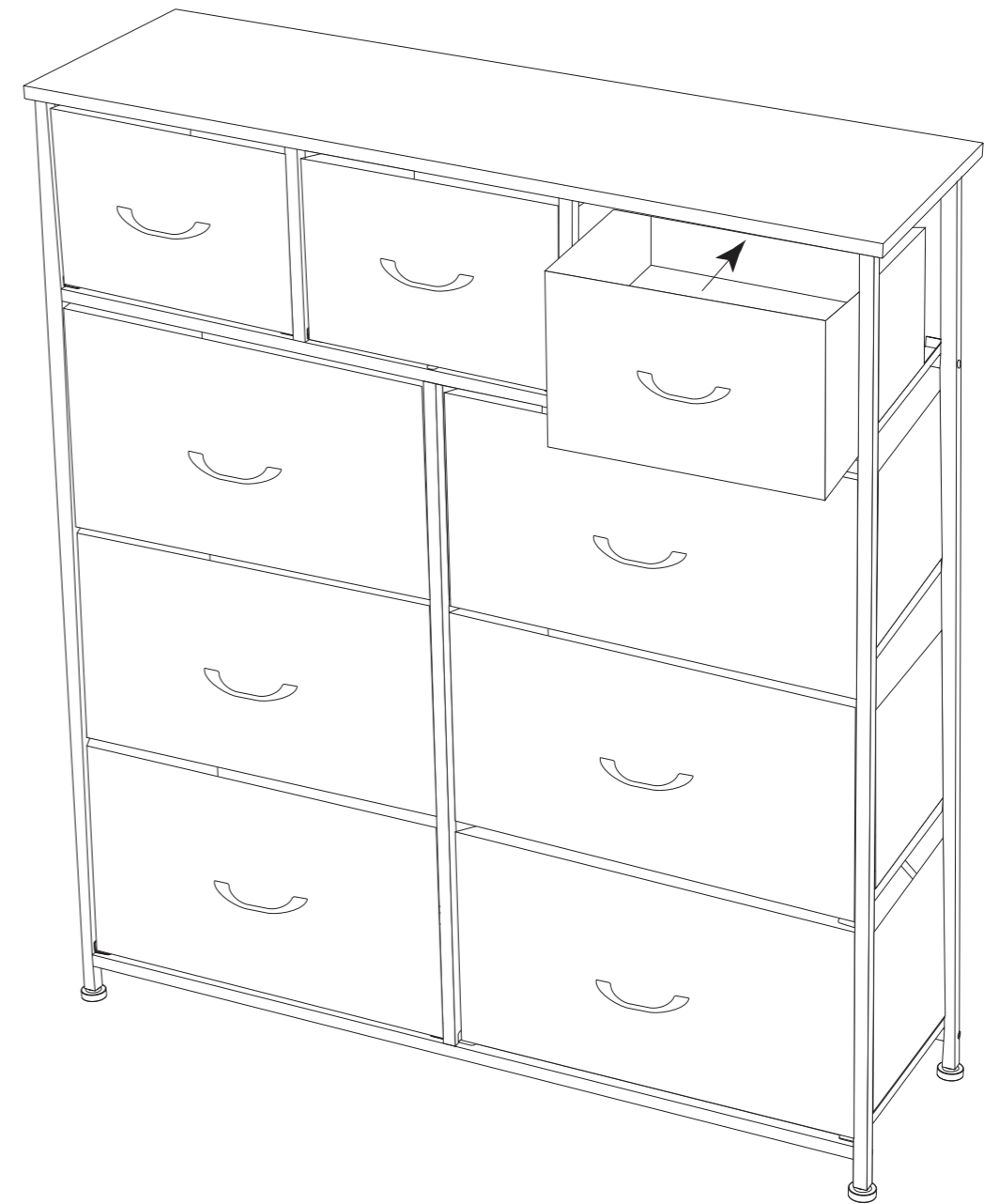

12



Installation Completed