

## PRODUCT DRAWING

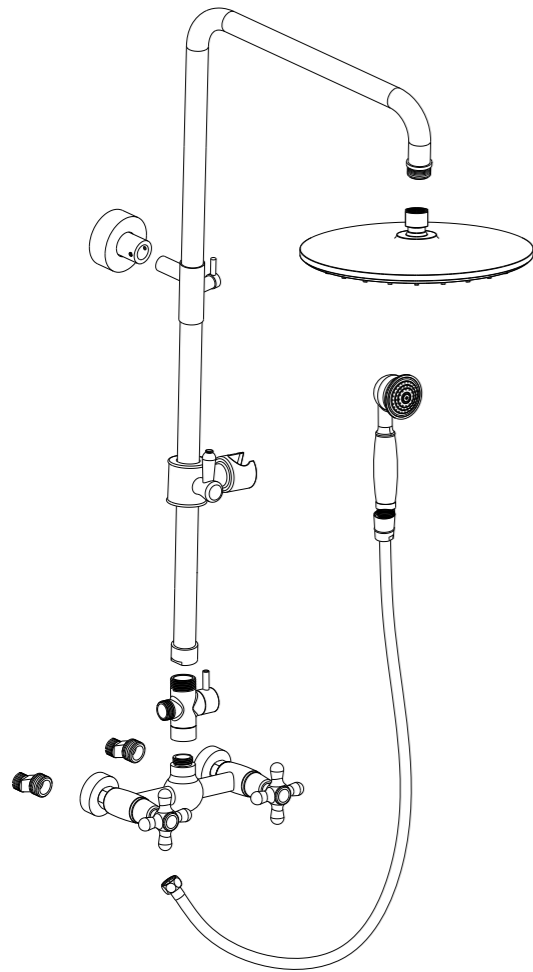

## RECOMMENDED TOOLS

Plumber's putty



Thread seal tape



Included

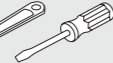

## INSTALLATION STEPS

### BEFORE YOU BEGIN

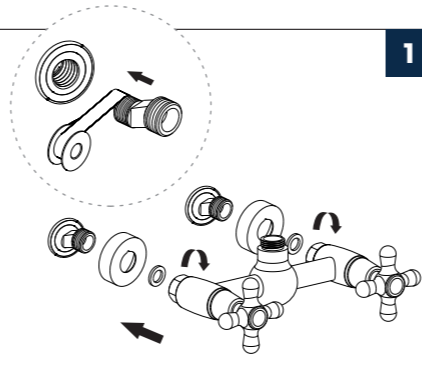
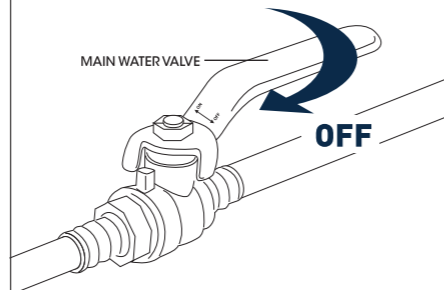

1

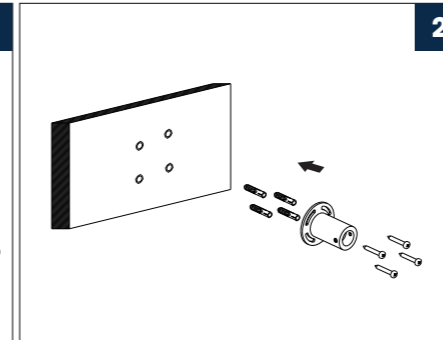

2

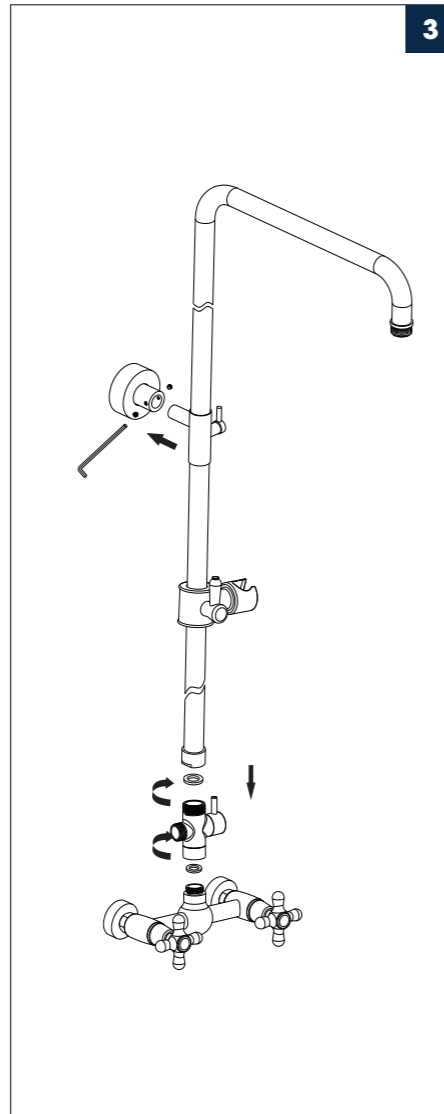

3

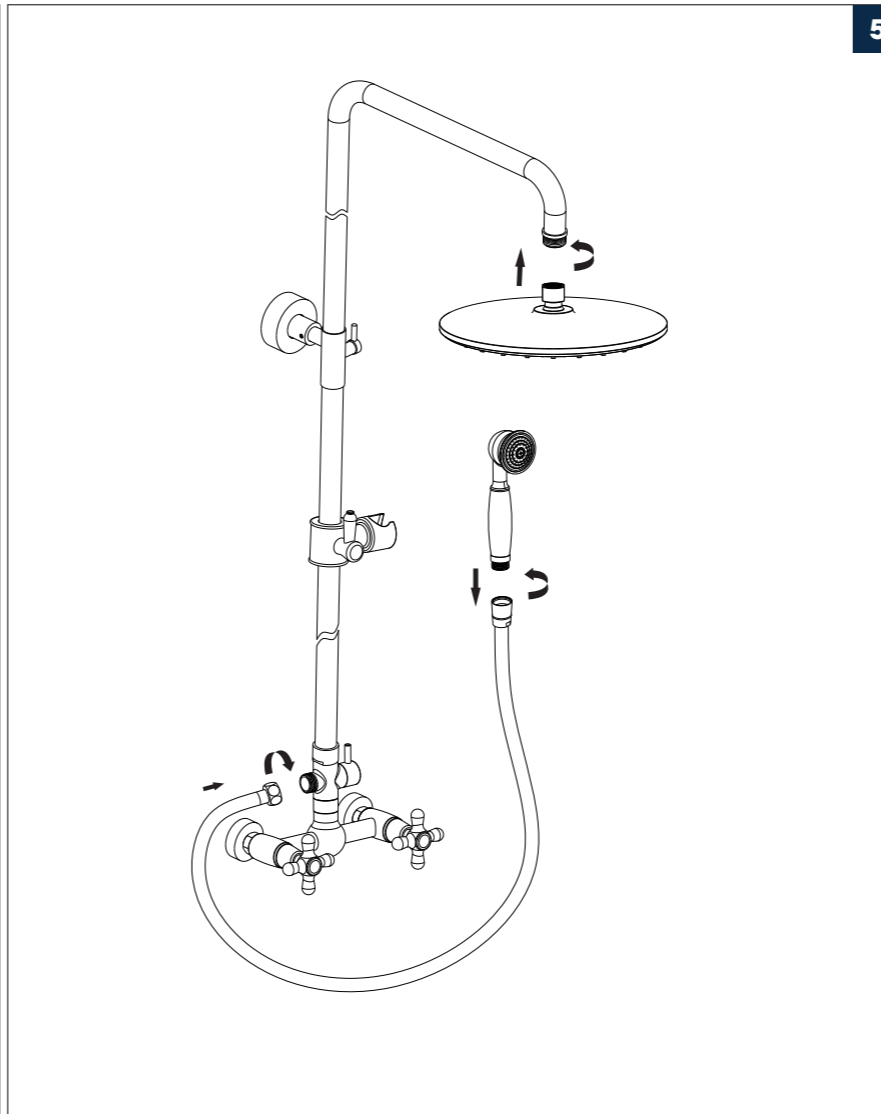

5

## SHOWER SYSTEM FAUCET

Installation instruction



MB/BN/BG/CH/ORB

### CARE INSTRUCTIONS

Rinse the product with clear water. Dry the product with a soft cloth.

### DO NOT:

Use abrasive cleansers, cloths, or paper towels. Use any cleaning agents containing acid, polish, wax, alcohol, ammonia, bleach, solvent or any other corrosive or harsh chemical cleansers.