

ASSEMBLY INSTRUCTIONS

Minimum No.
Of People
Recommended
To Assemble
This Product :

2

Approximate
Assembly
Time :

30
MINUTES

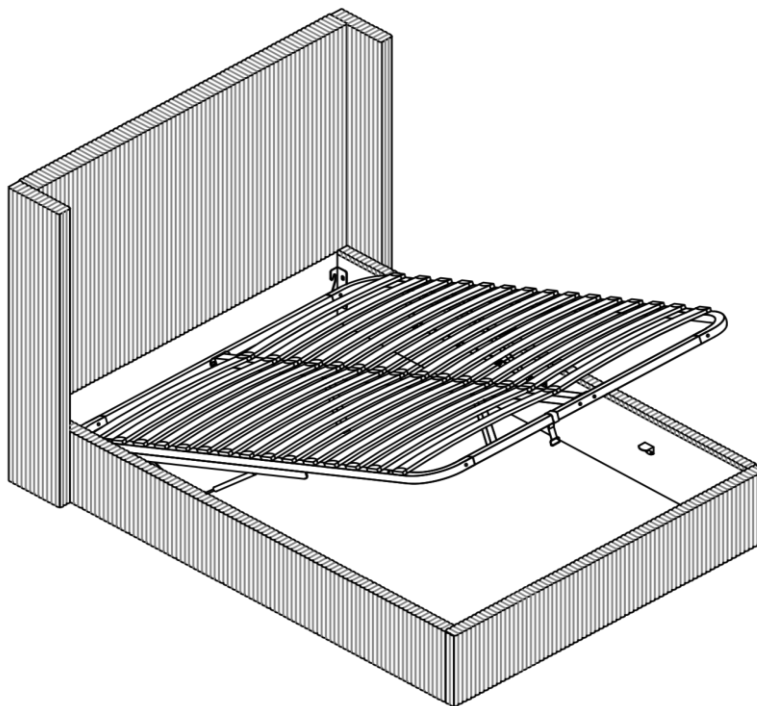











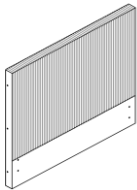
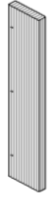

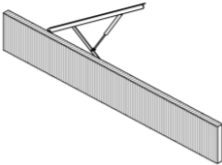
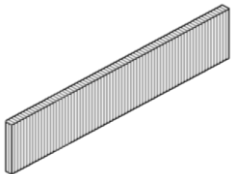
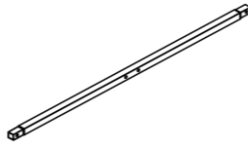

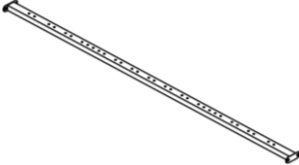

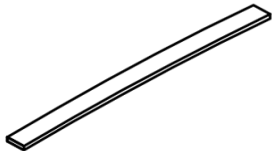
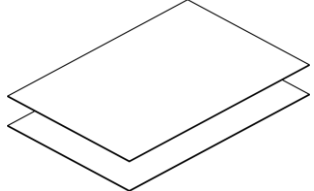

BEFORE YOU START, HERE IS SOME HELPFUL ADVICE :

1. We suggest you spend a short time reading through this leaflet and then follow the simple step by step instructions.
2. Please only use a mattress size that is relevant to the size of the bed frame purchased and that your **mattress weight is no more than 50kg.**
3. Do not discard any of the packaging until you have checked that you have all the parts and the pack of fittings is correct and you are happy with the product.
4. To ensure an easier assembly, we strongly advise that all fittings are only finger-tightened during initial assembly phase. Only upon completion of the assembly should all fixing points be fully tightened.
5. We recommend a periodic check on all fixing points to make sure they remain fully tightened.
6. Keep any fittings out of children's reach.

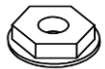

Do not use Power Tools

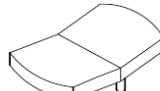
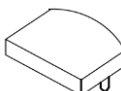
PARTS AND HARDWARE LISTS

<p>1 x1pc Head board</p> 	<p>2R x1pc Side head board</p> 	<p>2L x1pc Side head board</p> 	<p>3R x1pc Side rail</p> 
<p>3L x1pc Side rail</p> 	<p>4 x1pc Foot board</p> 	<p>5 x2pcs KD Metal frame End cross bar</p> 	<p>6 x2pcs KD Metal frame side bar</p> 
<p>7 x1pc KD Metal frame middle bar</p> 	<p>8 x2pcs Middle support leg</p> 	<p>9 x30pcs Slat</p> 	<p>10 x2pcs Base boards</p> 
<p>A x2pcs</p> 	<p>B x16pcs</p>  <p>M8x25mm</p>	<p>C x16pcs</p>  <p>M8x45mm</p>	<p>D x12pcs</p>  <p>M4x25mm</p>
<p>E x6pcs</p>  <p>M8x60mm</p>	<p>F x20pcs</p> 	<p>G x14pcs</p> 	<p>H x2pcs</p> 
<p>I x4pcs</p> 	<p>J x4pcs</p> 	<p>K x15pcs</p> 	<p>L x30pcs</p> 
<p>M x1pc</p> 			

STEP 1

Fix the Screw rod E to the Side head board ②L&Side head board ②R .

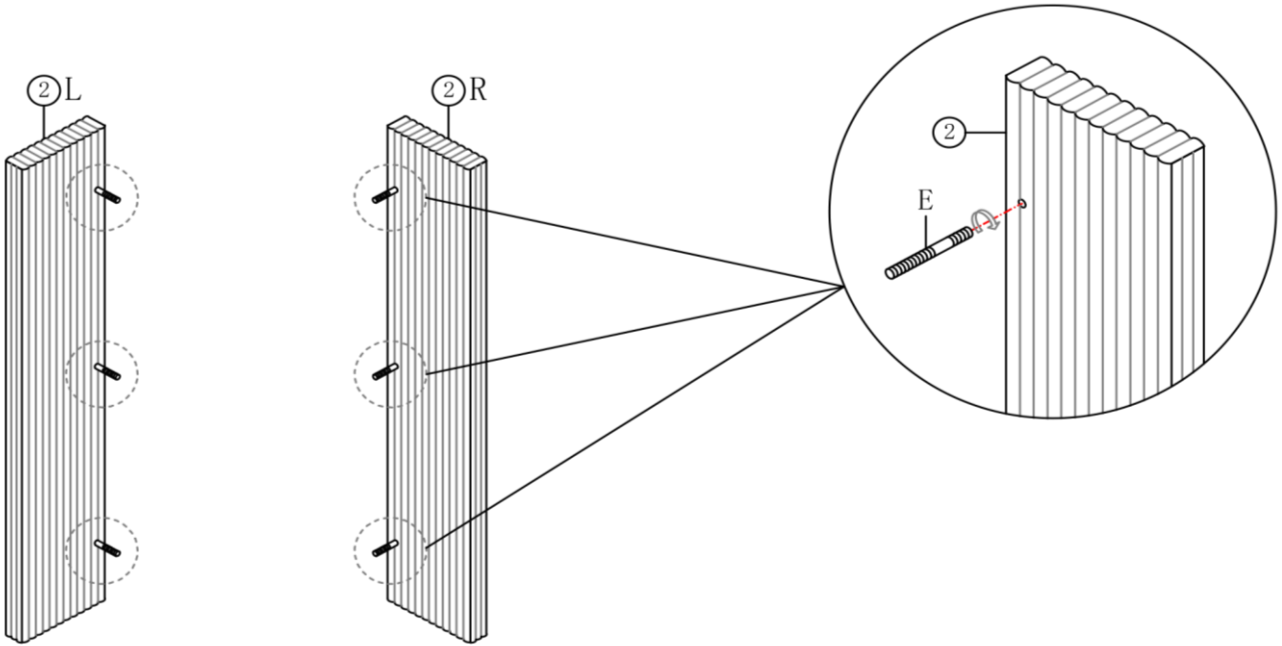

STEP 2

Fix the Side head board ②L&Side head board ②R to the Head board ① with Nuts F and Washer G by using Spanner H.

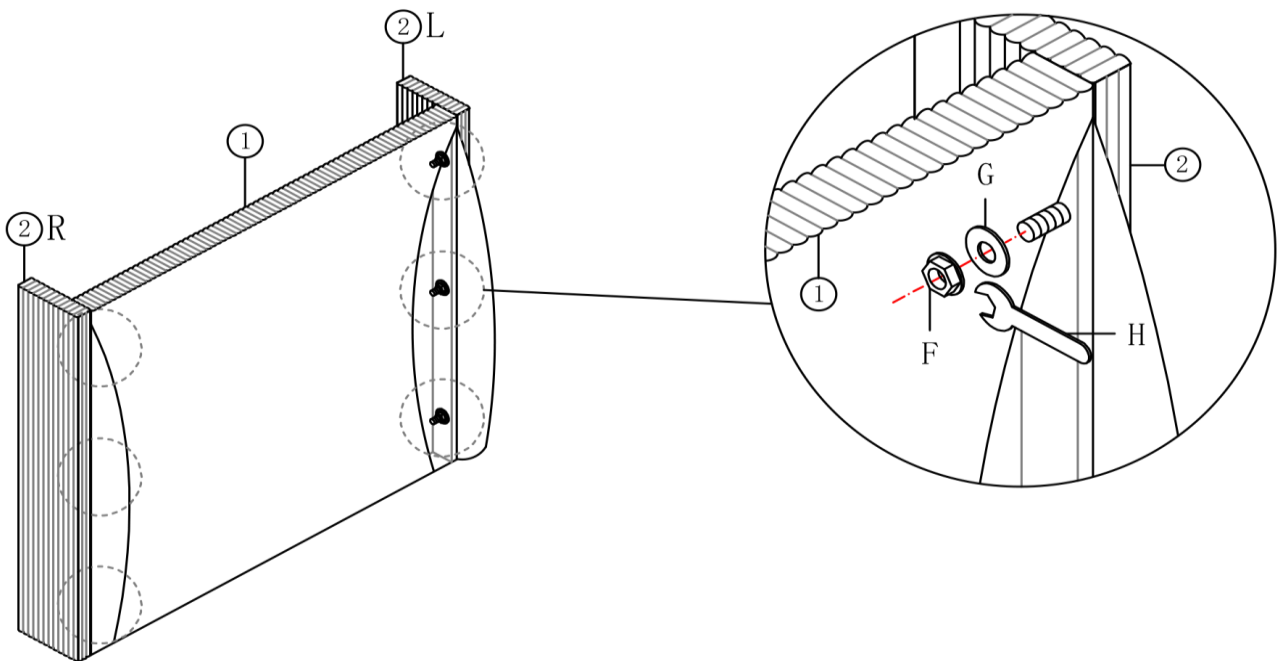

STEP 3

Fix the Side rail ③ to the Head board ① and Foot board ④ with Bolts B and Hinge I by using Allen key A.



Do not use Power Tools

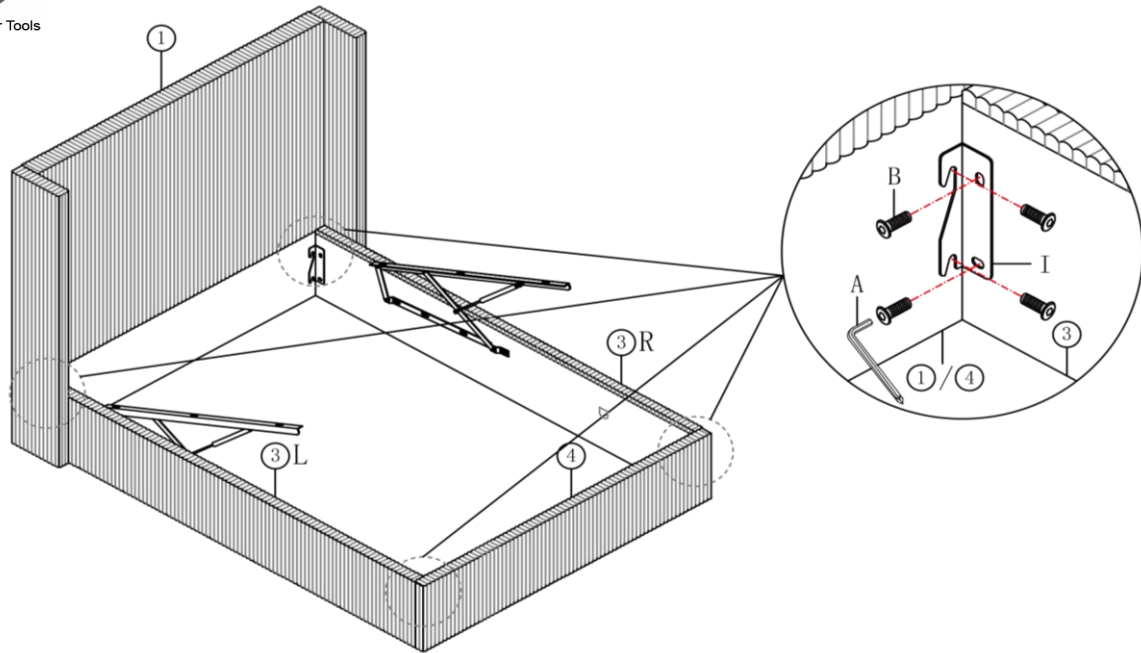

STEP 4

Place the plywood *Base Boards* ⑩ into the bottom storage area.

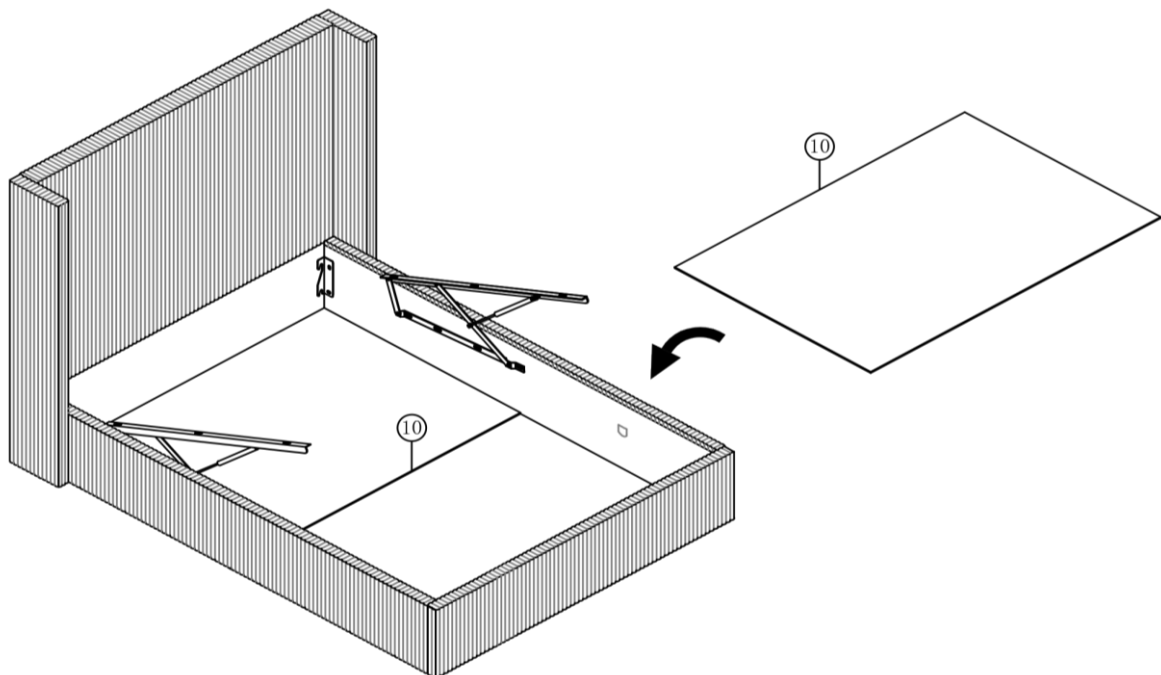

STEP 5

Fix the Plastic support J to the Side rail ③ and Foot board ④ with Nails D by using Allen key A.



Do not use Power Tools

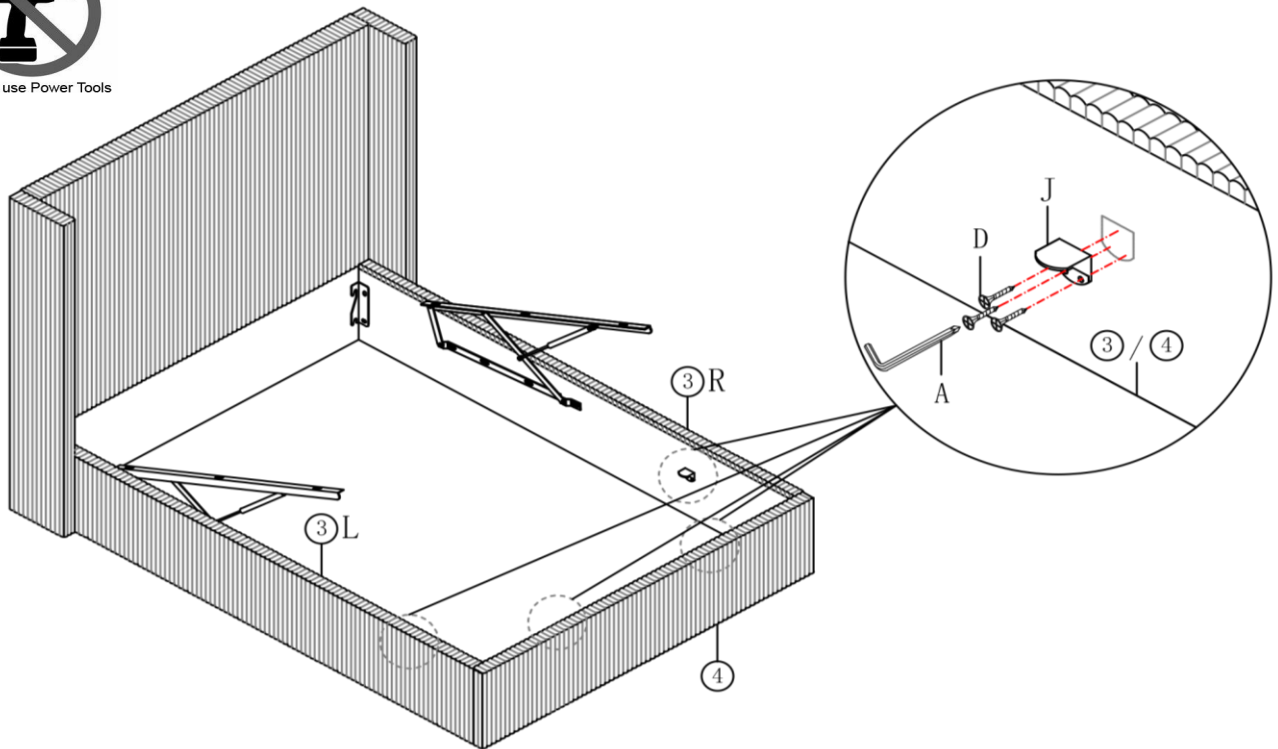

STEP 6

Assemble the KD metal frame with Bolts C , Nuts F and Washer G by using Allen Key A and Spanner H .



Do not use Power Tools

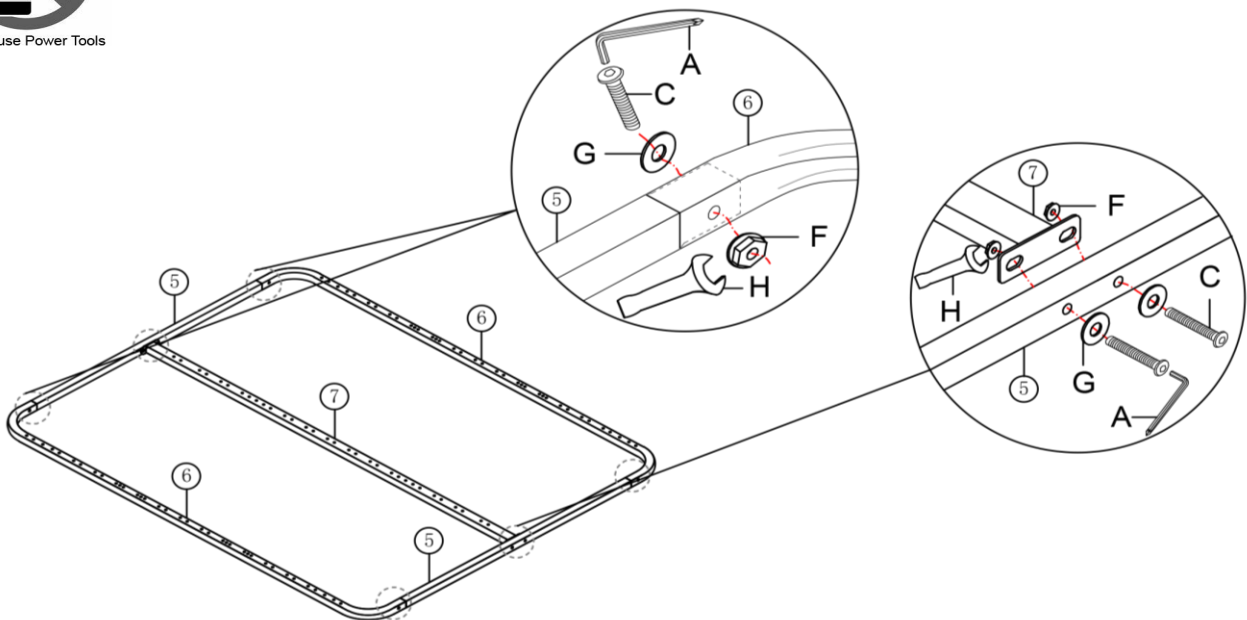

STEP 7

Fix the Middle support leg (8) to the KD Metal frame middle bar (7) with Bolts C by using Allen Key A.



Do not use Power Tools

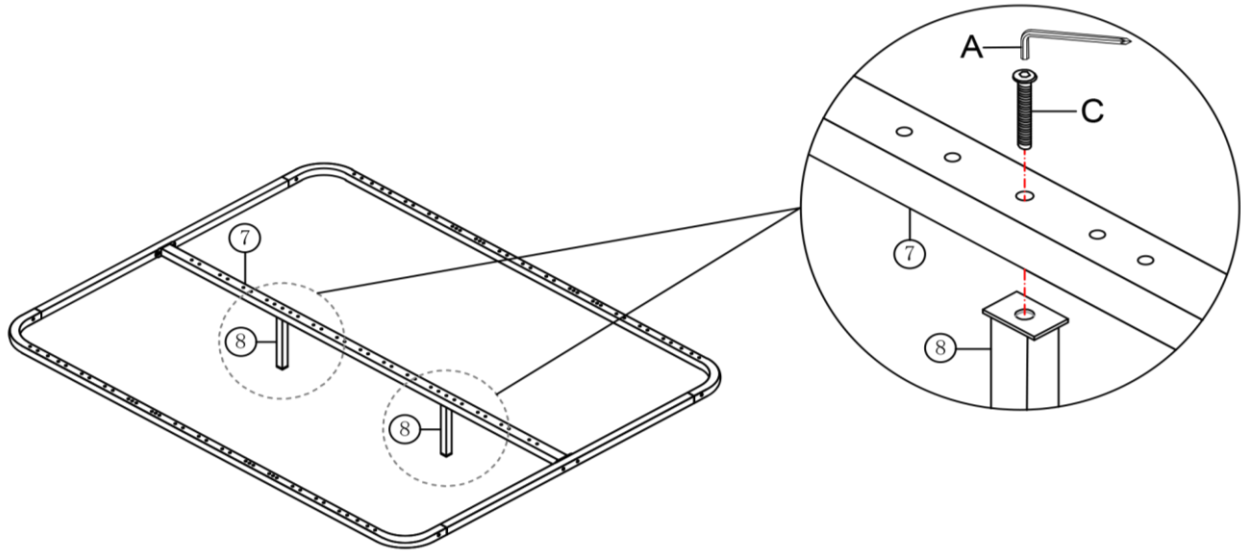

STEP 8

Fix the KD Metal frame to the Gas lift with Bolts C and Nuts F by using Allen Key A and Spanner H.



Do not use Power Tools

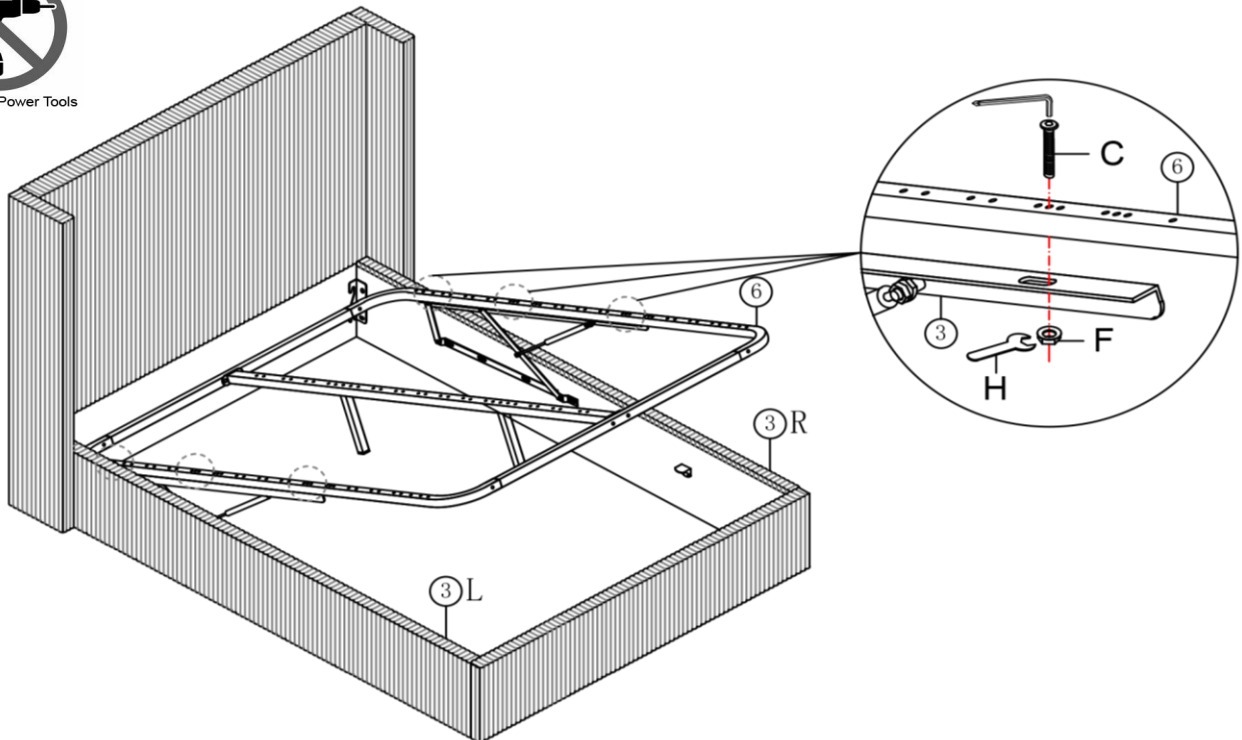

STEP 9

Assemble the Slats ⑨ into the KD Metal frame with Middle caps K and End caps L.

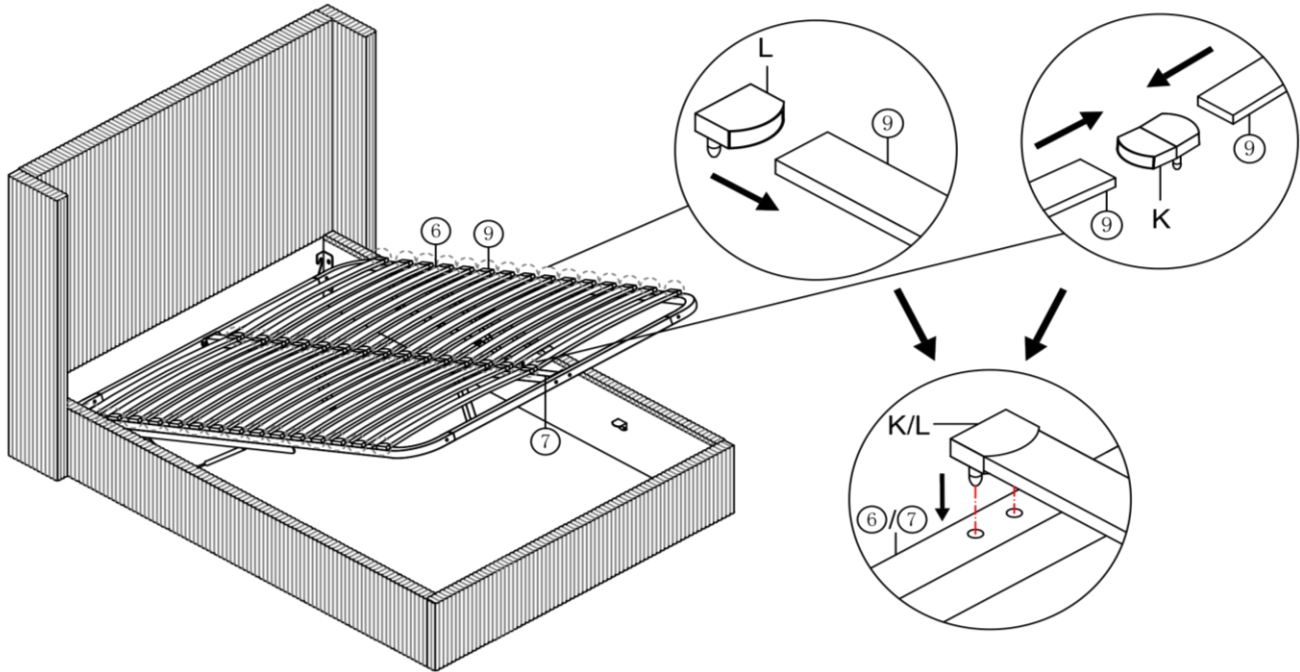

STEP 10

Put the pull Black tape M in side middle of the KD Metal frame.

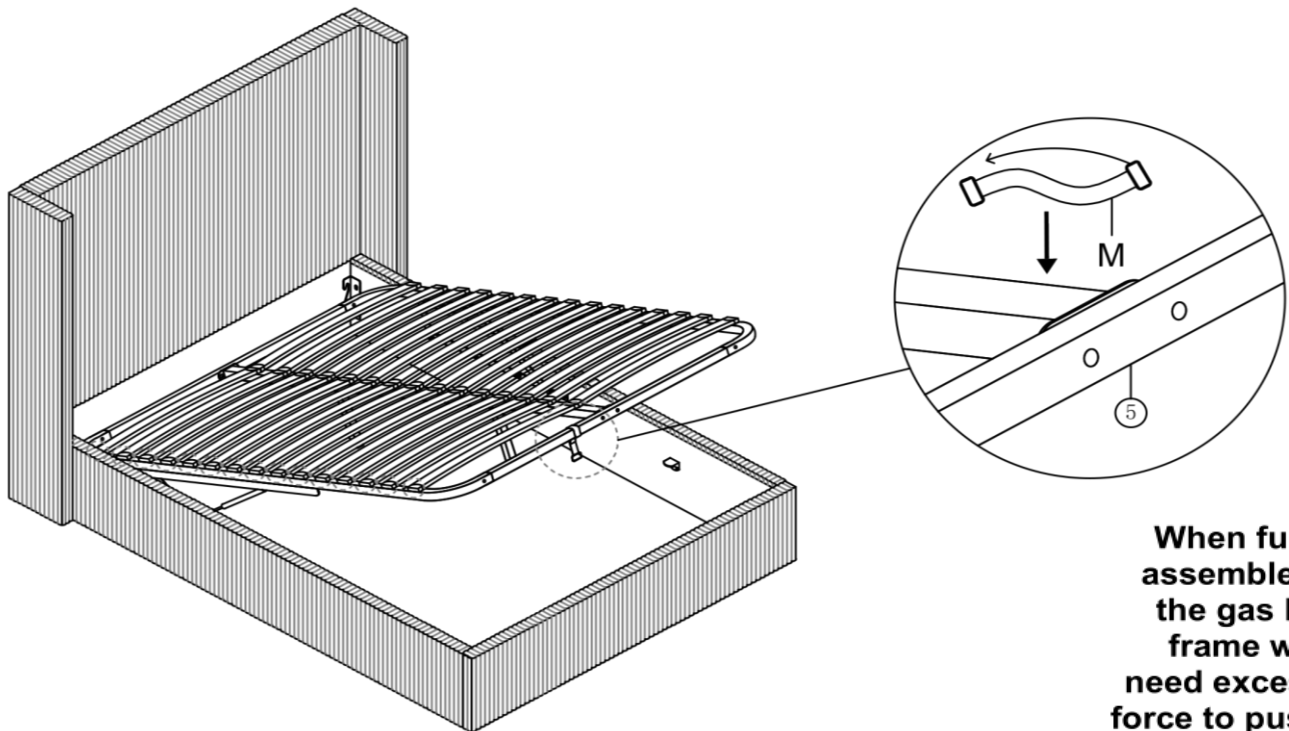

When fully assembled, the gas lift frame will need excess force to push down on