

SOFA

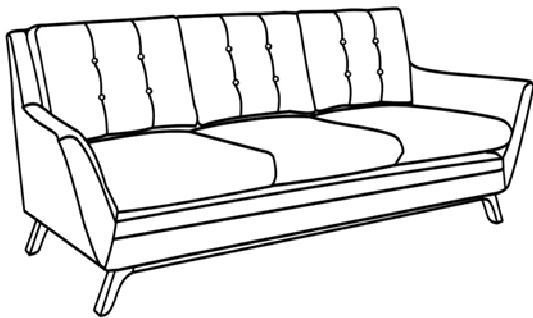



Thank you for purchasing the **SOFA!**

Before you start, here is some helpful advice:

1. We suggest you spend a short time reading through this leaflet and then follow the simple step by step instructions.
2. Owing to the size and weight of the chair/loveseat/sofa, we recommend that it is assembled by two adults, on a carpeted or padded area, in the room that it is intended for. Approximate assembly time: 15 minutes.
3. Please do not use any tools other than those provided or recommended in these instructions.
4. Please do not throw away any of the packaging or instructions until you have checked all the components and hardware and the furniture is fully assembled.
5. Assemble all components loosely until advised to tighten. Depending on use, it may be necessary to tighten the components from time to time, so please save the tools that have been provided.
6. Please keep all pieces out of reach of small children.



Hardware:

A		Bolt	x8
B		Spring Washer	x8
C		Flat Washer	x8
D		Allen Wrench	x1

Component:

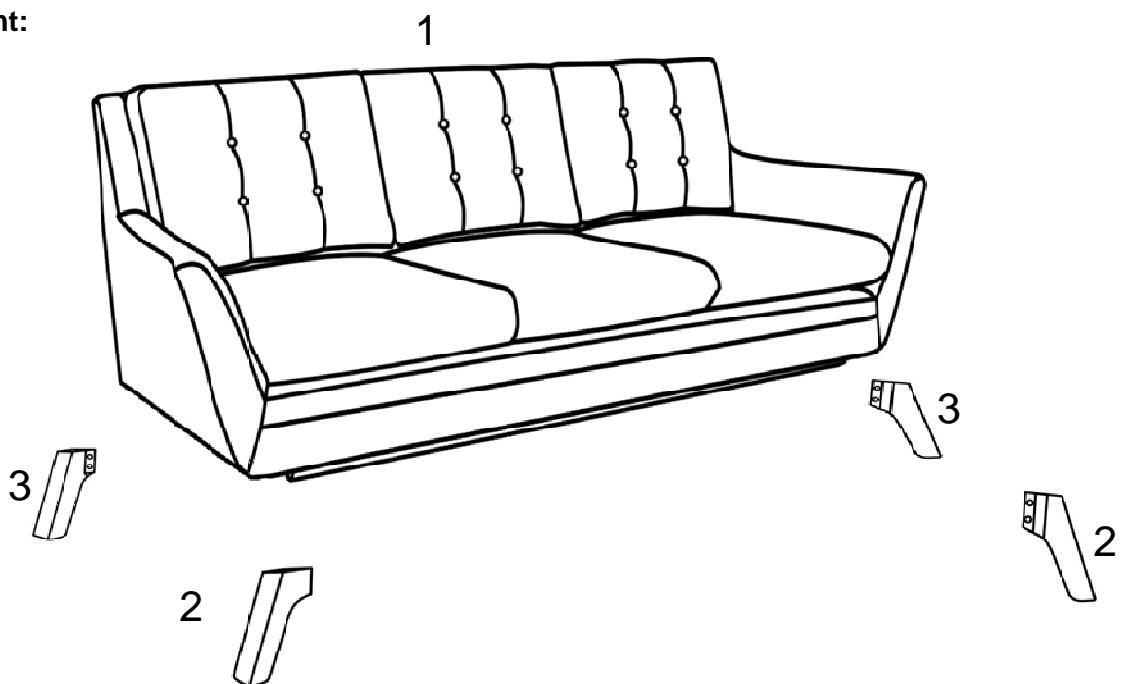

1 Sofa Body x1
3 Sofa Back Leg x2

2 Sofa Front Leg x2

SOFA

STEP 1:

Please put the **Sofa Body (1)** upside down on a carpeted or padded area by two adults to make fully visible the corners.

Open the Zipper on the bottom of **Sofa Body (1)** as shown.

Take out the 4pcs **Sofa Legs (2&3)** and hardware package on bottom of the **Sofa Body (1)**.

Position one of **Sofa Front Legs (2)** at one of the four wooden corners.

Insert 2 pieces of each **Spring Washer (B)**, **Flat Washer (C)** into 2 pieces of **Bolt (A)** as shown.

Then insert assembled 2 pieces of **Bolts (A)** into the corner to connect the **Sofa Front Leg(2)**.

Use **Allen Wrench (D)** to tighten all of **Bolts (A)**.

Repeat the same steps for the remaining of **Sofa Front legs (2)** and two pieces of **Sofa Back Leg (3)**.

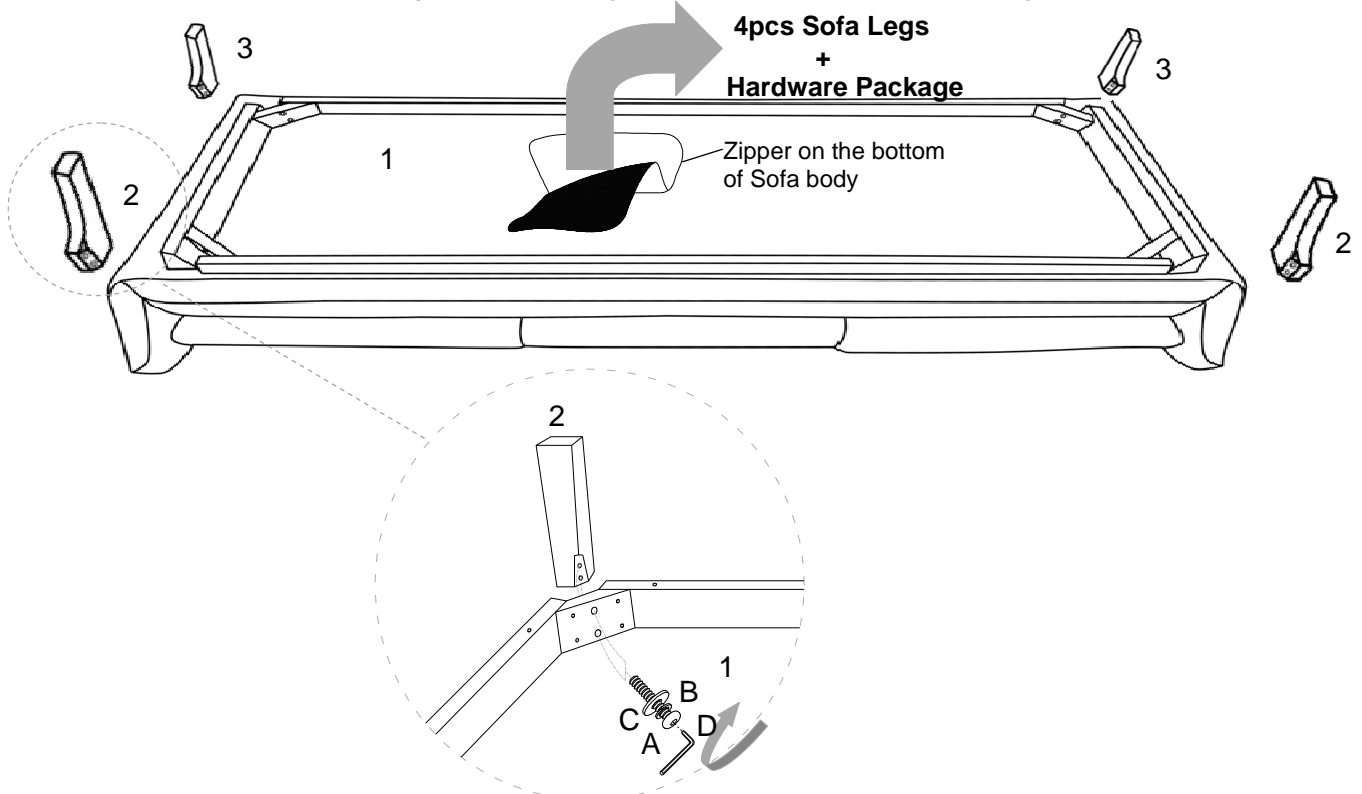

Ax8	Bx8	Cx8	Dx1

Hardware & Tool required

STEP 2:

Carefully turn over the sofa.

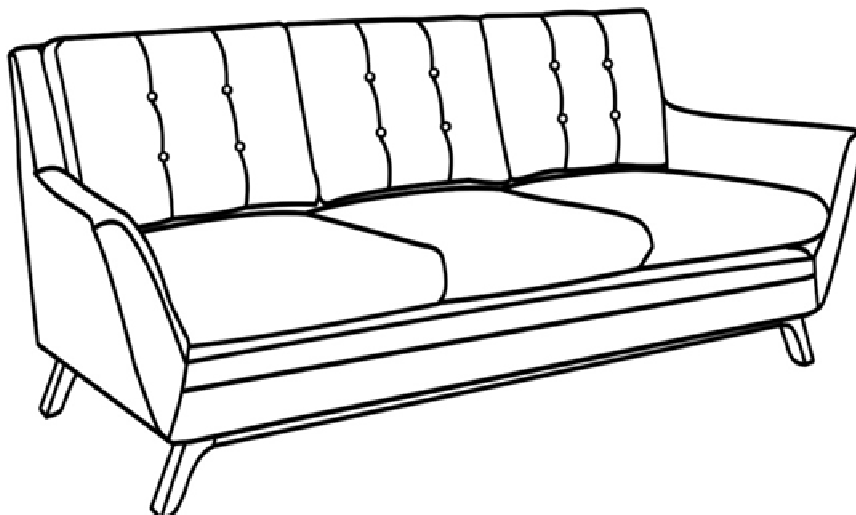

Assembly is completed. The sofa is ready to enjoy now!