

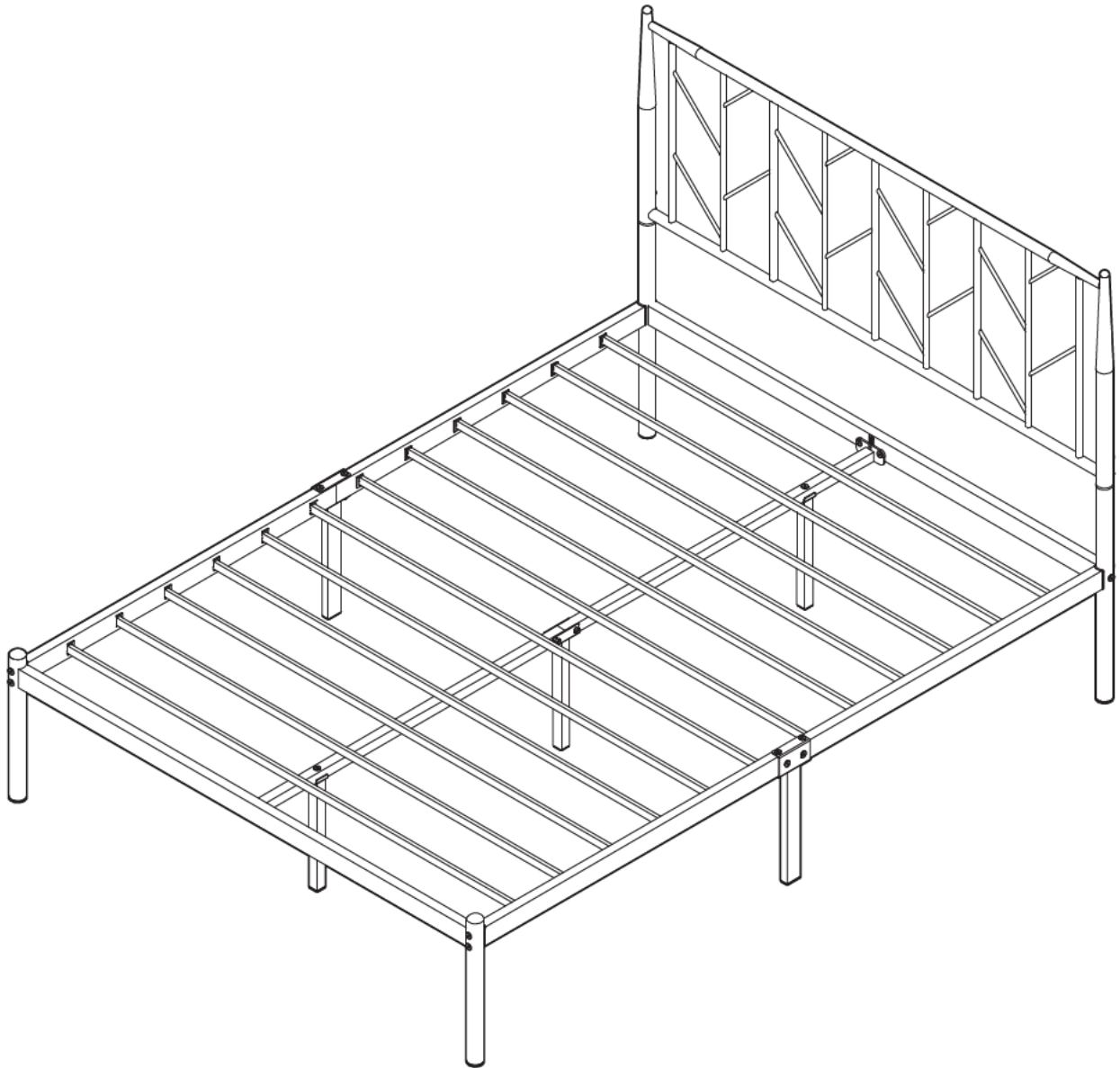



ORIGINAL INSTRUCTION MANUAL

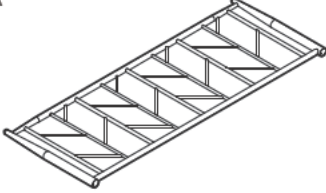
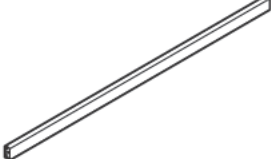
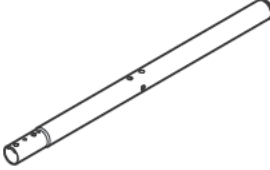
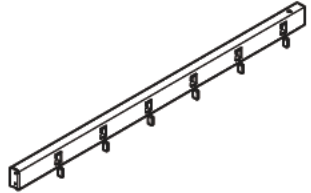
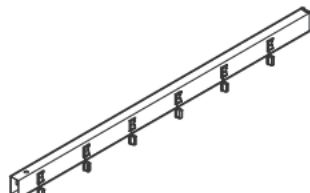
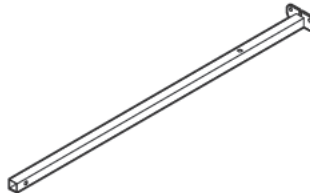
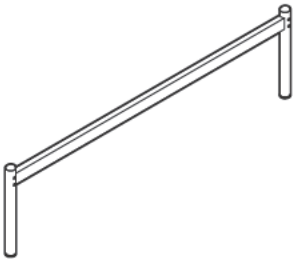
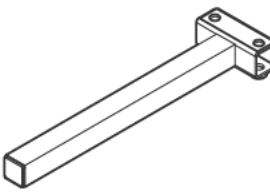
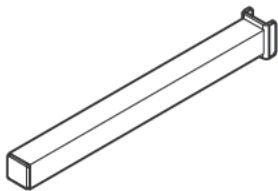
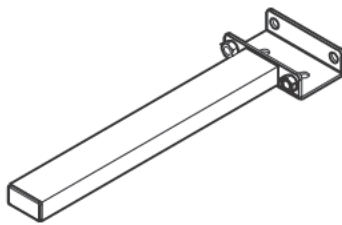
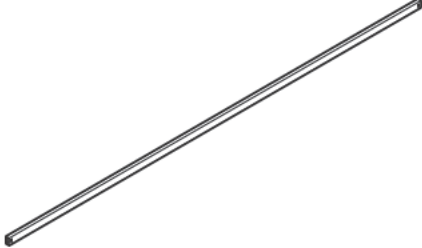

DEAR CUSTOMER,

Thank you for choosing our product. Please read this manual carefully before assembling or using the product, to avoid damage caused by improper use. If the product is passed on to third parties, this manual has to be passed on along with the product. For any question don't hesitate to contact us.

PARTS LIST

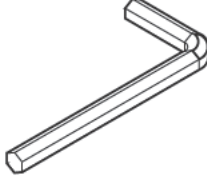
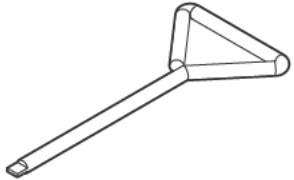
<p>A 1×</p> 	<p>B 1×</p> 	<p>C 2×</p> 
<p>D 2×</p> 	<p>E 2×</p> 	<p>F 2×</p> 
<p>G 1×</p> 	<p>H 1×</p> 	<p>I 2×</p> 
<p>J 2×</p> 	<p>K 12×</p> 	
<p>L1 4×</p>  <p>M8×65MM</p>	<p>L2 10×</p>  <p>M8×50MM</p>	<p>L3 12×</p>  <p>M8×14MM</p>
<p>L4 4×</p>  <p>M8×40MM</p>	<p>L5 1×</p> 	<p>L6 1×</p> 

ASSEMBLY

Before your installation, please make sure that you have all the parts listed on the manual. If you find something missing, stop installing and contact your supplier immediately.

NOTE: Please DO NOT tighten any hardware until all the components are assembled. Be sure to tighten all the hardware once the assembly completed.

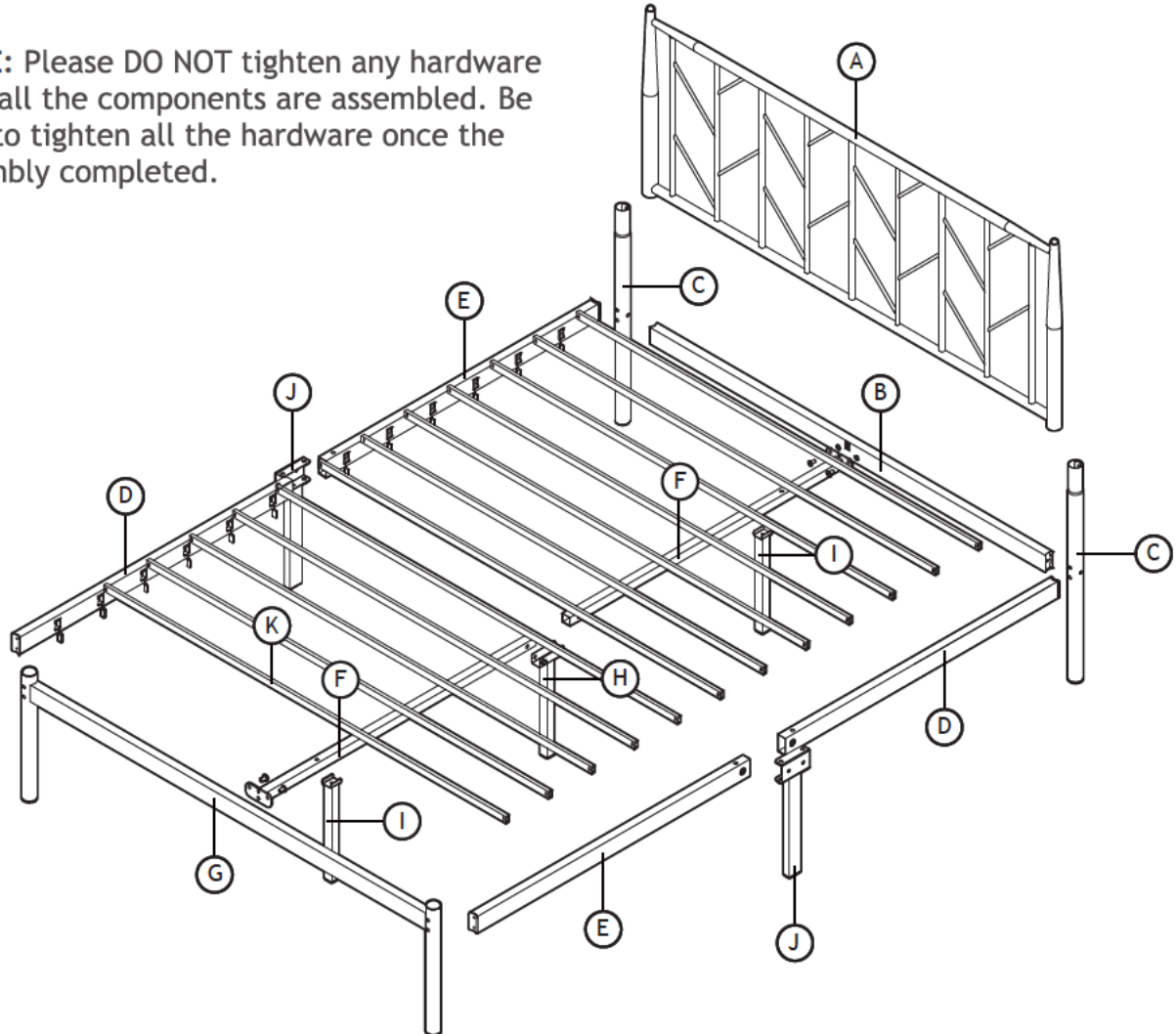

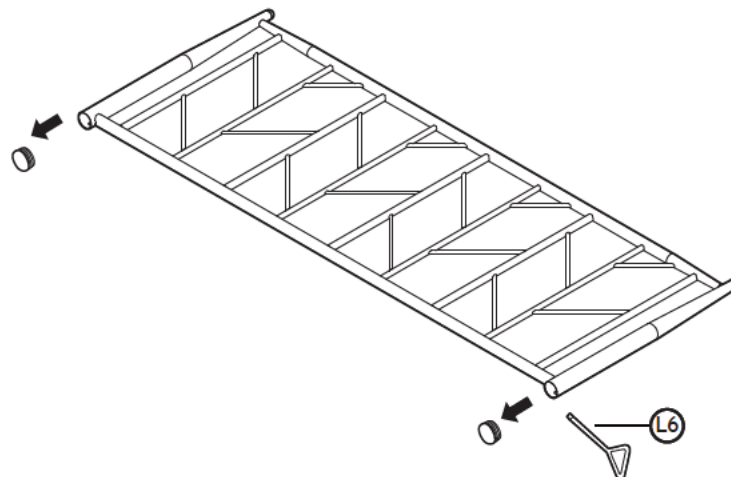

Please take off the Anti-bent plugs before assembly the headboard!
(note: please do not damage the paintwork)



ASSEMBLY

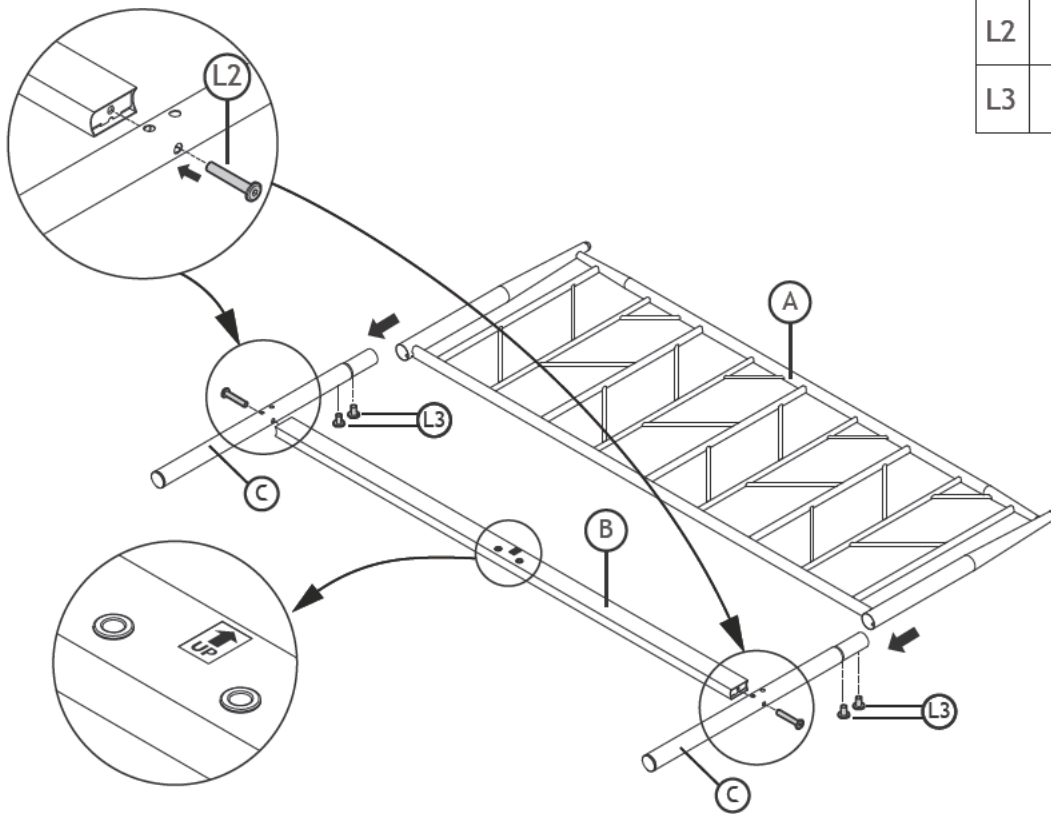

1

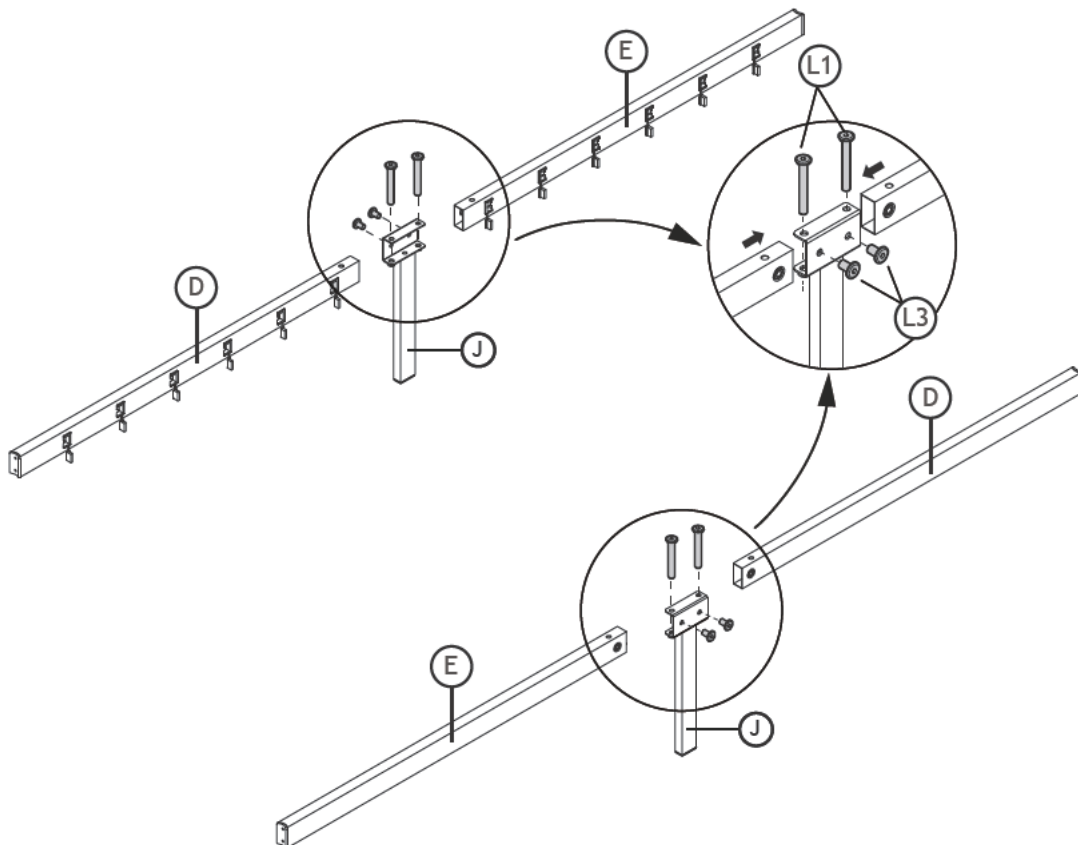

L2		x2
L3		x4

2



L1		x4
L3		x4

ASSEMBLY

3

L4  x4
M8x40

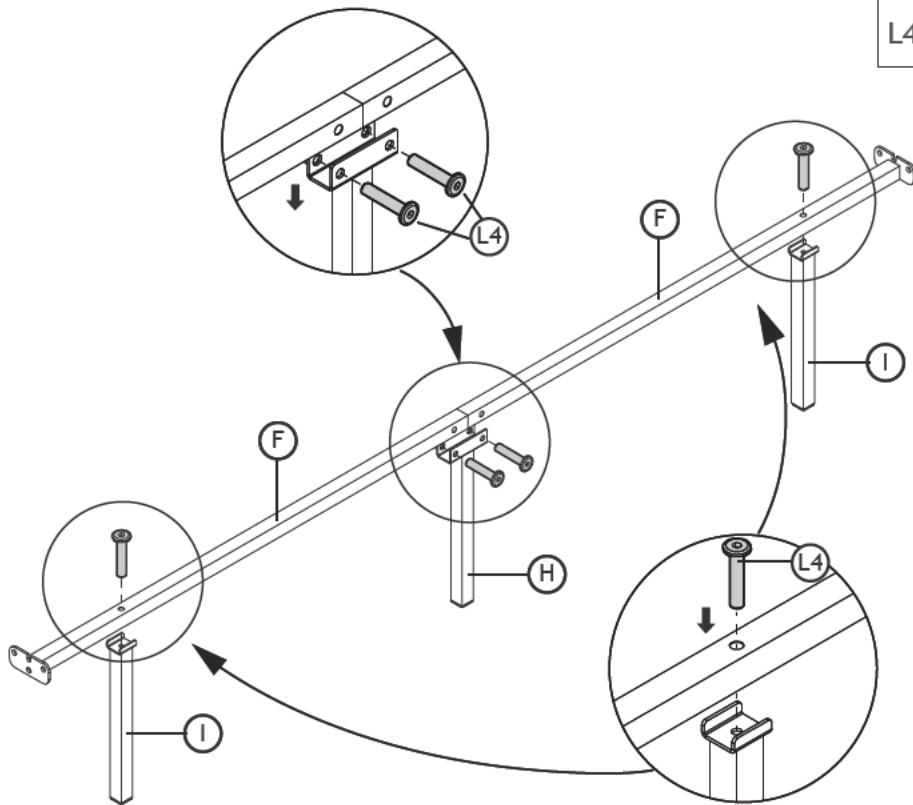

4

L2  x8
M8x50

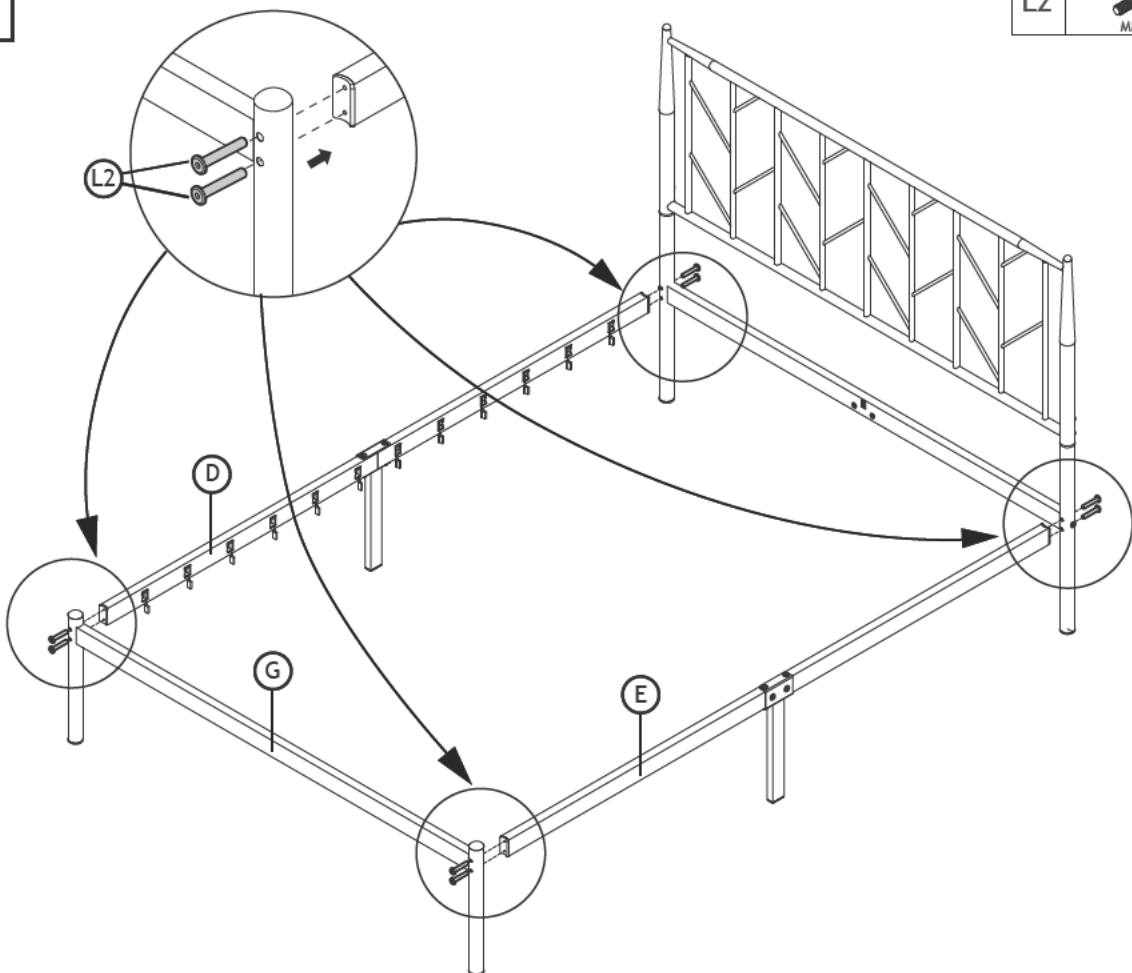

5

ASSEMBLY

5

L3  x4
M8x14

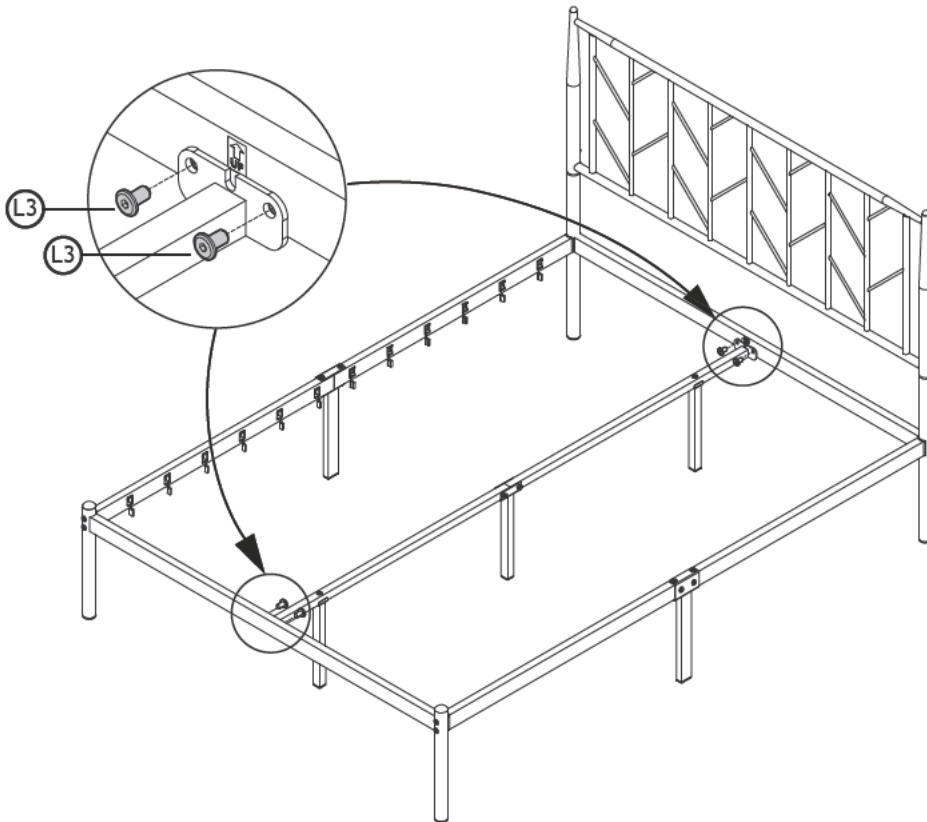

6

Note: Please push to the bottom!

