





Installation & Assembly

Please read instructions carefully.

Remove all wrapping materials, staples and packing straps from the carton. Refer to Parts List and Hardware List and ensure they are complete before you start assembling. Place all wooden parts on a clean, flat and soft surface (e.g carpet or rug) to prevent parts from being scratched.

- CAUTIONS:
- 1) DO NOT FULLY TIGHTEN BOLTS AND NUTS UNTIL ALL PARTS HAVE BEEN ASSEMBLED.
 - 2) DO NOT OVER-TIGHTEN BOLTS AND NUTS UNTIL ALL PARTS HAVE BEEN ASSEMBLED.
 - 3) KEEP ALL HARDWARE PARTS OUT OF REACH CHILDREN.

NO.	COMPONENT	QTY.
P1	TABLE TOP	1
P2	PEDESTAL LEG	1
P3	MOUNTING PANEL	1

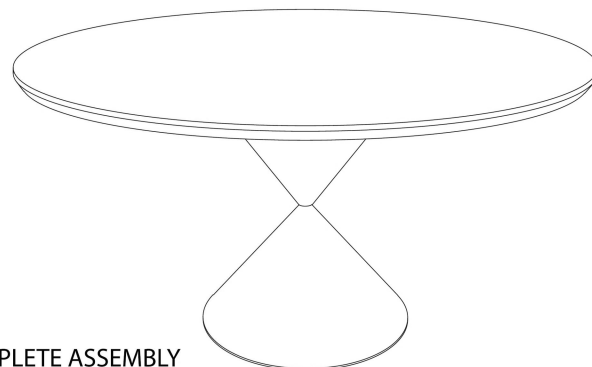

NO.	HARDWARE LIST	QTY.
H1	M6 x 35mm JCBC SCREW 	8
H2	SPRING WASHER 	8
H3	FLAT WASHER 	8
H4	LEG LEVELER 	4
H5	ALLEN KEY 	1



COMPLETE ASSEMBLY

STEP 1



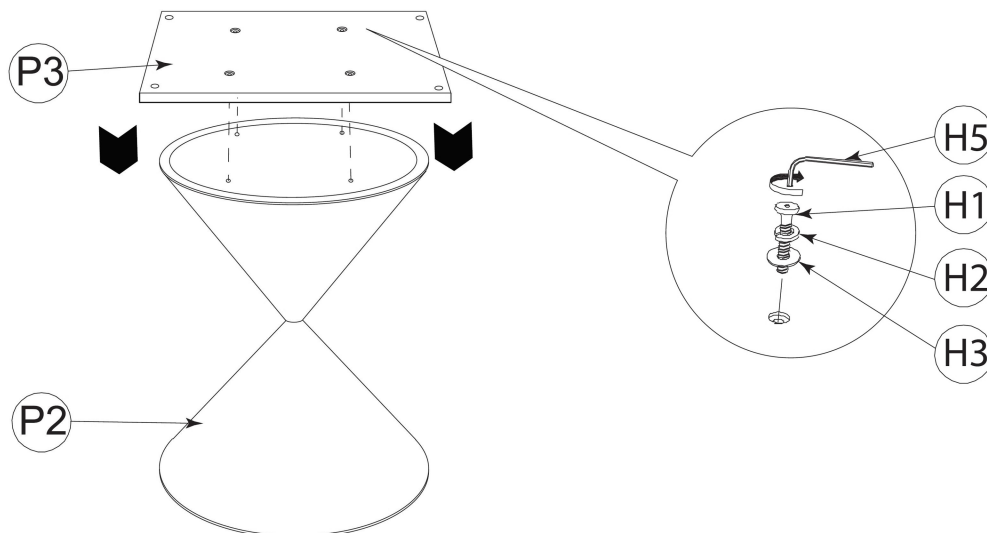

Assemble the Mounting Panel (P3) to the top end of the Pedestal Leg (P2) by aligning the Bolt (H1) that fitted with the Spring Washer (H2) and the Flat Washer (H3). Tighten the Bolts using the provide Allen Key (H5).

H1 x 4		M6 x 35mm
H2 x 4		
H3 x 4		



STEP 2

Attach the Pedestal Leg (P2) with the Mounting Panel (P3) with it, to the underside of the Table Top (P1). Align the Bolts (H1) that fit with the Spring Washer (H2) and the Flat Washer (H3) right through the holes in the Mounting Panel to the Nuts in the Table Top. Tighten all the bolts using Allen key (H5). Before turning the Table upright, drive the Leg Leveler (H4) to the holes in the bottom of the Pedestal leg.

H1 x 4		M6 x 35mm
H2 x 4		
H3 x 4		
H4 x 4		

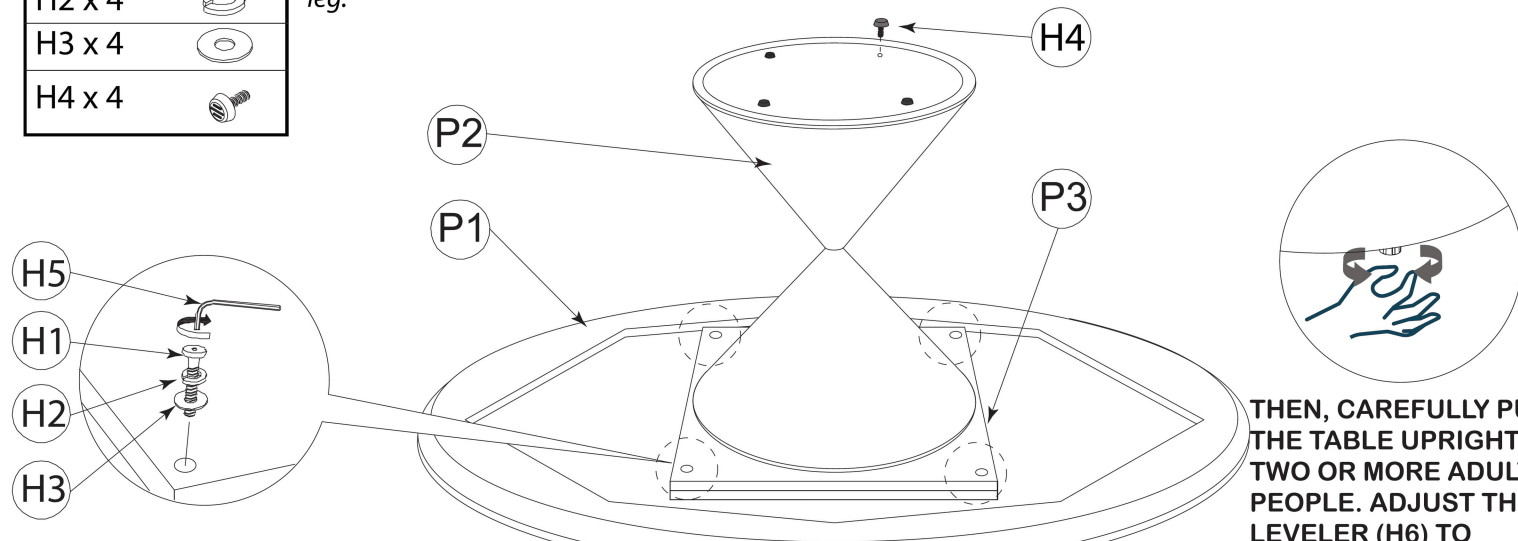

THEN, CAREFULLY PUT THE TABLE UPRIGHT BY TWO OR MORE ADULT PEOPLE. ADJUST THE LEVELER (H6) TO