

ASSEMBLY INSTRUCTION

PLEASE READ BEFORE ASSEMBLING!

Tip #1: Make sure you've taken all the pieces and hardware out of its packaging before discarding the box.

Tip #2: Using page 2 and/or page 3 of instruction manual make sure all pieces and hardware are accounted for.

Tip #3: Read manual before assembling, it helps!

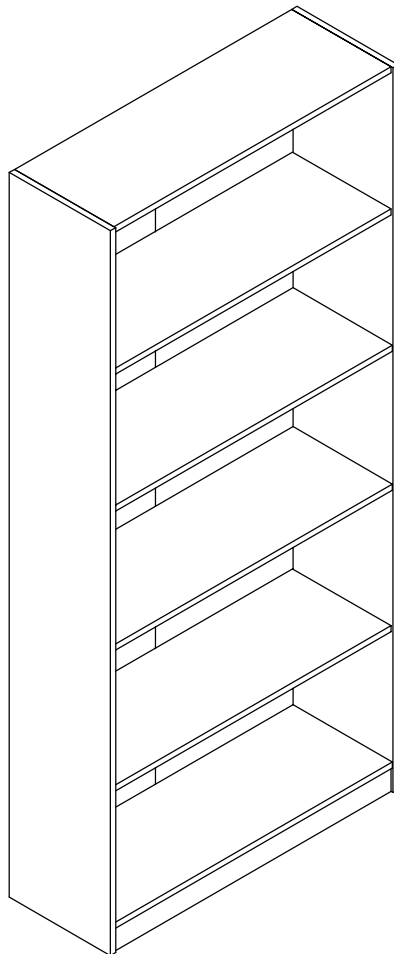



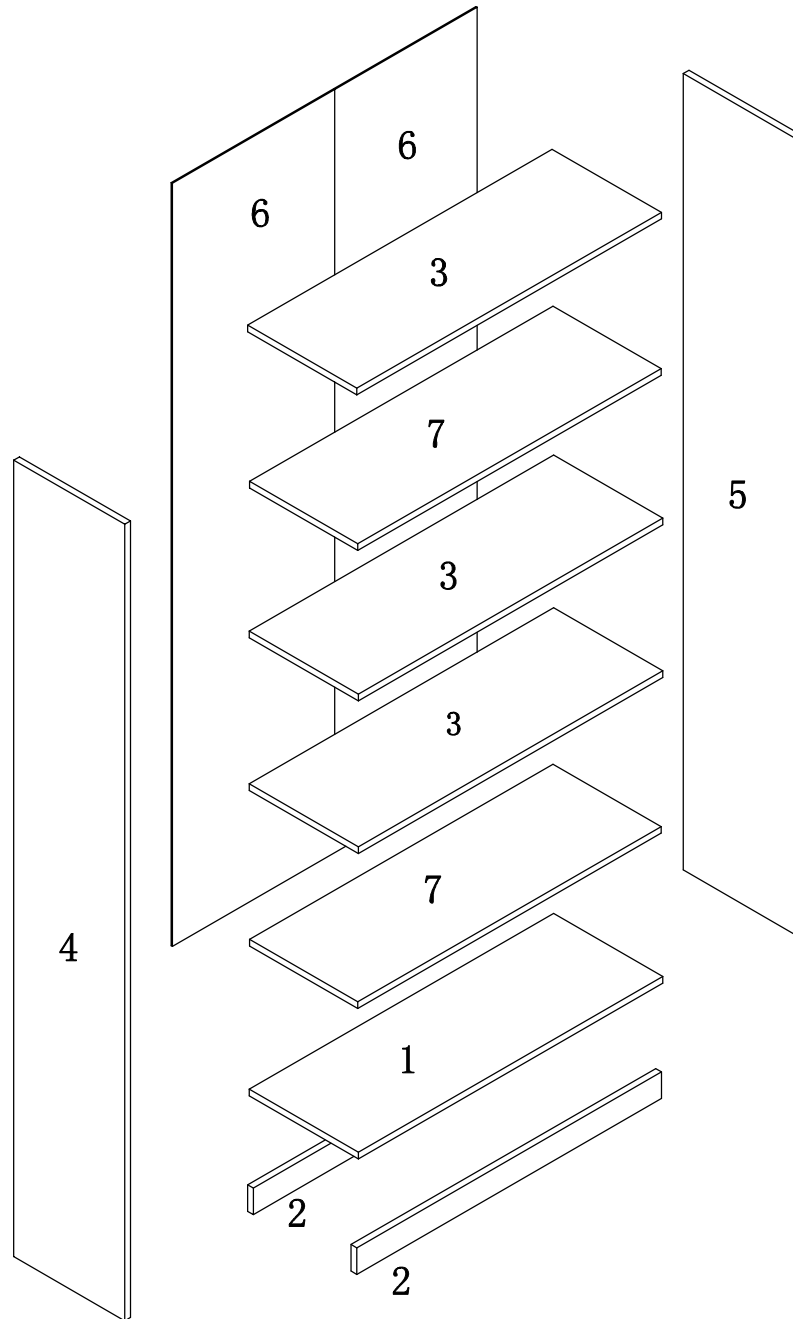



PARTS IDENTIFICATION

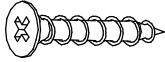

(1)	1pc	(5)	1pc
(2)	2pcs	(6)	2pcs
(3)	3pcs	(7)	2pcs
(4)	1pc		

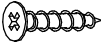
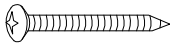
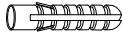
HARDWARE IDENTIFICATION

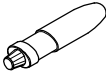
A		$\phi 4 \times 35$	16pcs
B			50pcs
C		$\phi 5$	8pcs
D		$\phi 8 \times 25$	18pcs
E			1pc
F		$\phi 4 \times 25$	1pc
G		$\phi 5 \times 40$	1pc
H			1pc
I		$\phi 16$	8pcs
J		Glue: For securing please apply to wood dowel first before inserting into panel	1pc

ASSEMBLY INSTRUCTION

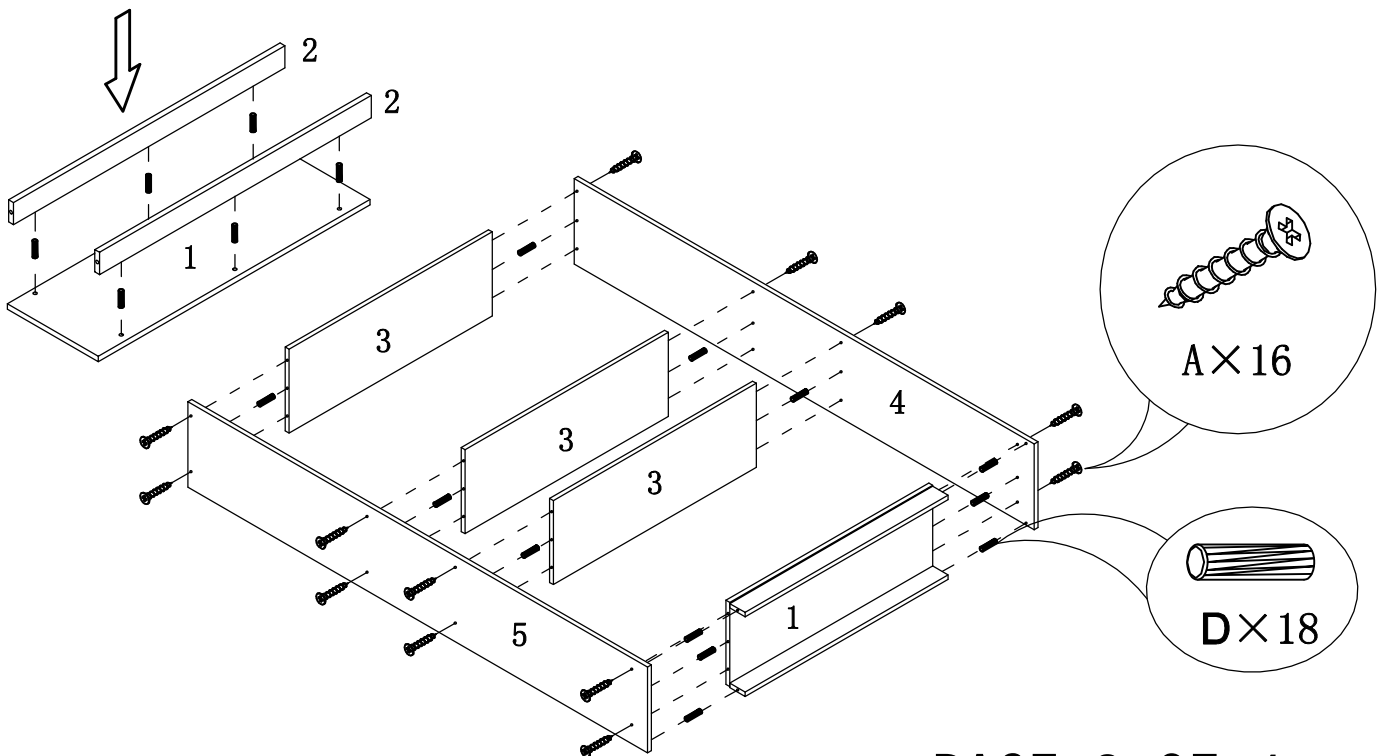

ASSEMBLY INSTRUCTION

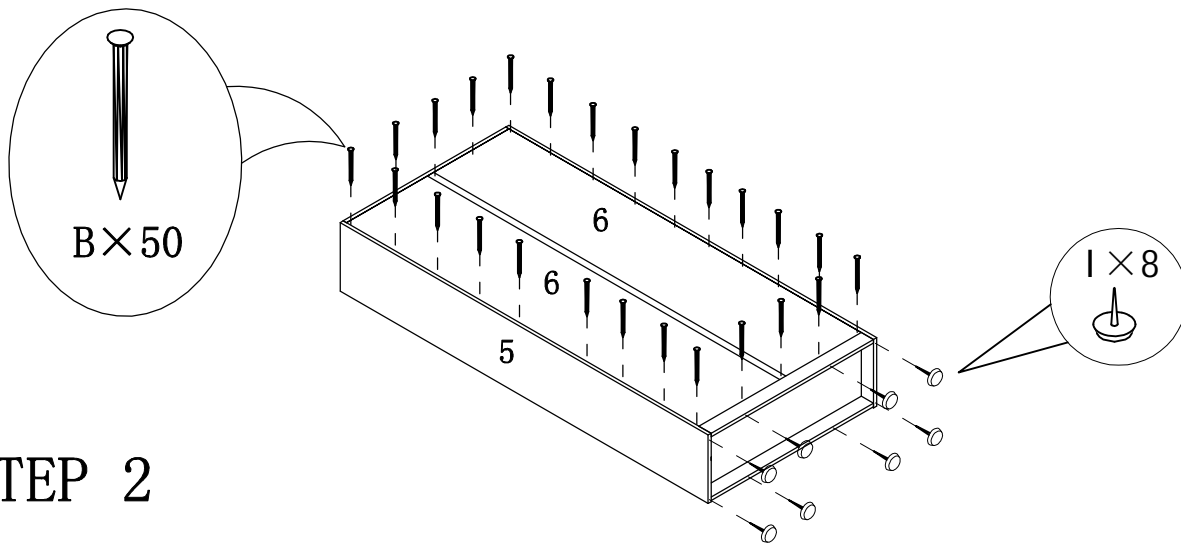

STEP 2

STEP 3

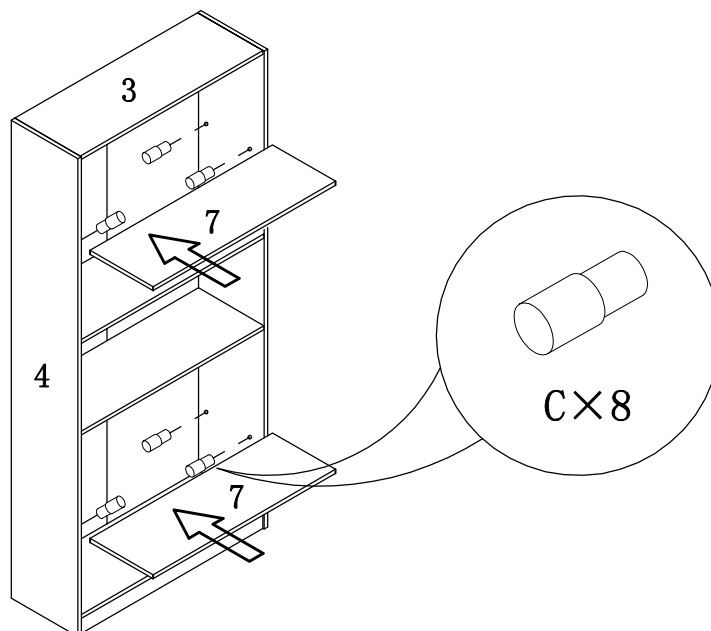

STEP 4

