

Pure & Easy



ASSEMBLY INSTRUCTIONS

NOTICE

IMPORTANT, RETAIN FOR FUTURE REFERENCE: READ CAREFULLY
WICHTIG, FÜR SPÄTERE NACHSCHLAGE AUFBEWAHREN: SORGFÄLTIG LESEN
IMPORTANTE, GUARDAR PARA REFERENCIA FUTURA: LEER ATENTAMENTE
IMPORTANTE, CONSERVARE PER RIFERIMENTI FUTURI: LEGGERE ATTENTAMENTE
IMPORTANT, À CONSERVER POUR RÉFÉRENCE FUTURE : LIRE ATTENTIVEMENT

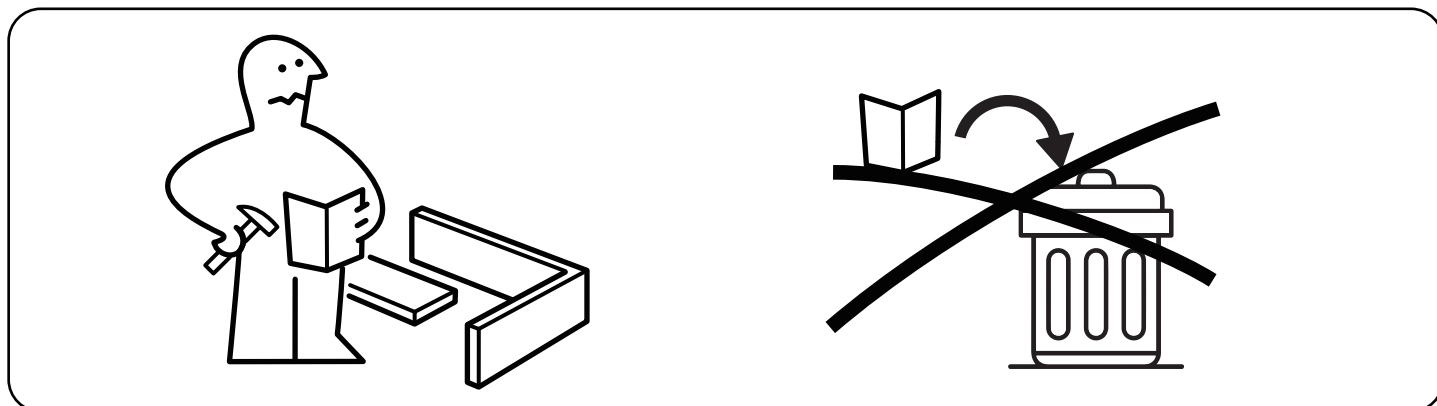

Assemble on a flat and solid surface. To avoid the unstable surface affecting the overall frame stability during installation.

Montieren Sie auf einer ebenen und festen Oberfläche. Um zu verhindern, dass eine unebene Oberfläche während der Montage die Gesamtrahmen-Stabilität beeinträchtigt.

Ensamblar en una superficie plana y sólida. Afin d'éviter que la surface inégale n'affecte la stabilité générale du cadre lors de l'installation.

Assemblare su una superficie piana e solida. Per evitare che una superficie irregolare influisca sulla stabilità complessiva della struttura durante l'installazione.

Assemble on a flat and solid surface. Para evitar que la instalación en una superficie irregular afecte la estabilidad general del marco.

Professional installation is highly recommended.
Eine professionelle Installation wird dringend empfohlen.
Une installation professionnelle est fortement recommandée.
Si raccomanda vivamente l'installazione professionale.
Se recomienda altamente la instalación profesional.



Periodically Check That All Components Are Tightly Secured.
Überprüfen Sie Regelmäßig, Dass Alle Komponenten Fest Gesichert Sind.
Vérifiez Périodiquement Que Tous Les Composants Sont Bien Fixés.
Controllare Periodicamente Che Tutti I Componenti Siano Ben Fissati.
Verifique Periódicamente Que Todos Los Componentes Estén Bien Asegurados.

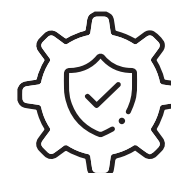

It is recommended that multiple people assemble this product.
Es wird empfohlen, dass mehrere Personen dieses Produkt zusammenbauen.
Il est recommandé que plusieurs personnes assemblent ce produit.
Si raccomanda che più persone assemblino questo prodotto.
Se recomienda que varias personas ensamblen este producto.

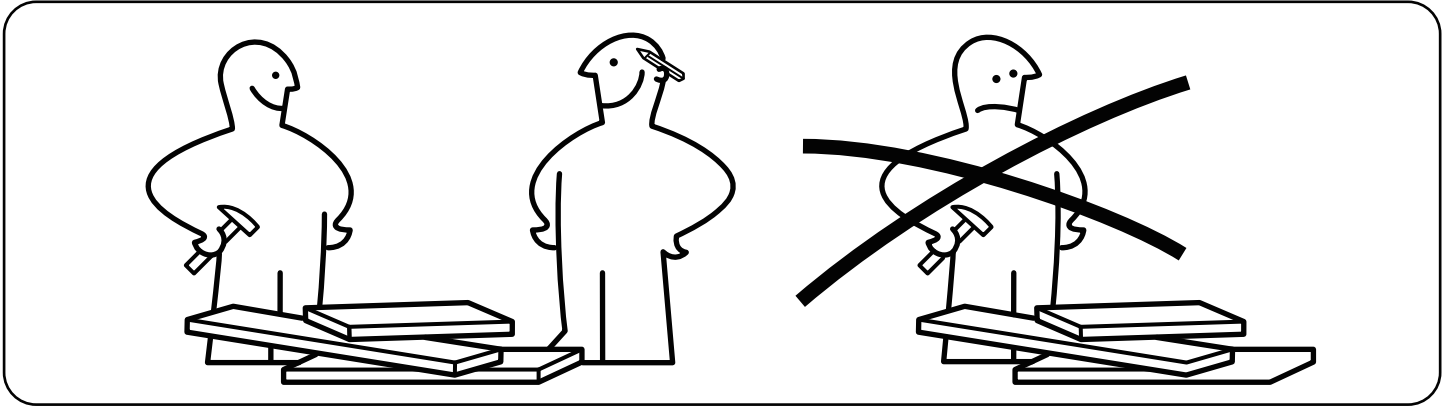







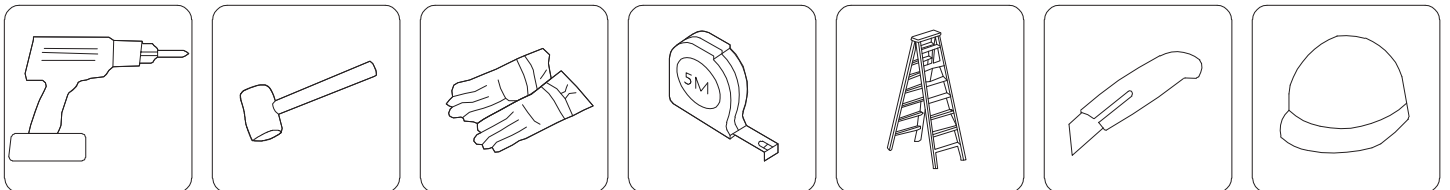

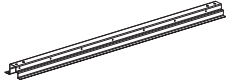
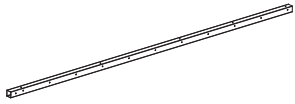
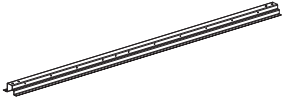
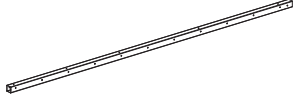

Please contact us if parts of your furniture are missing.
Bitte kontaktieren Sie uns, wenn Teile Ihrer Möbel fehlen.
Por favor contáctenos si faltan piezas de sus muebles.
Si prega di contattarci se mancano parti dei vostri mobili.
Veuillez nous contacter si des pièces de vos meubles manquent.

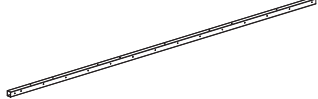

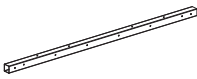
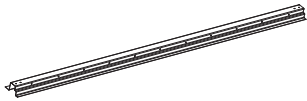
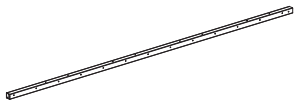

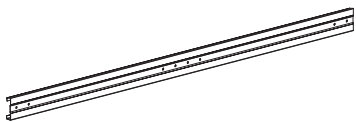
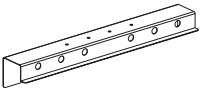
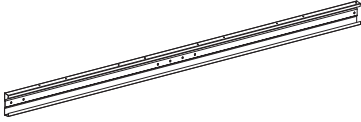

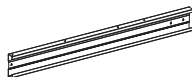
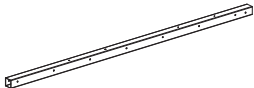
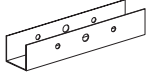
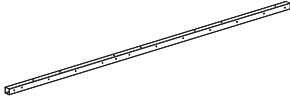
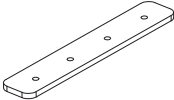

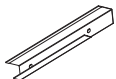

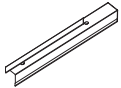
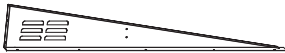
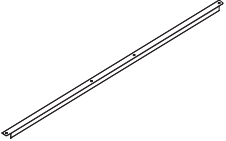

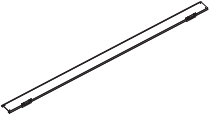

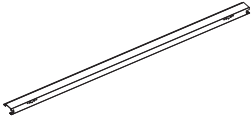
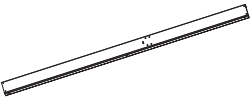
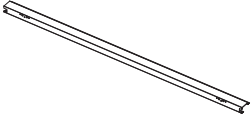
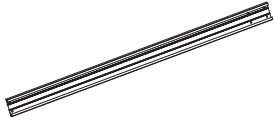
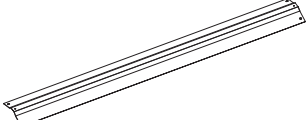
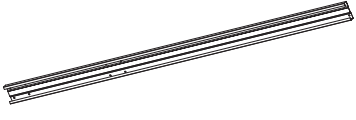

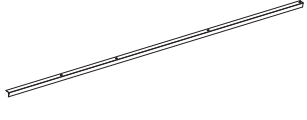
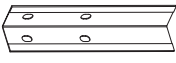



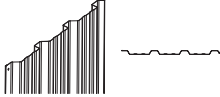
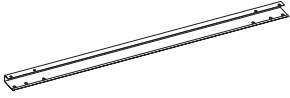







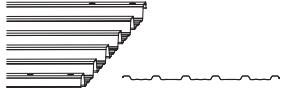
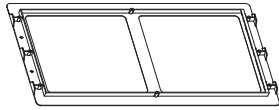
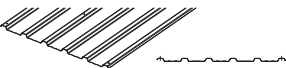
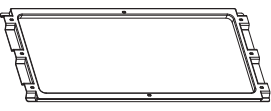
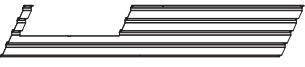

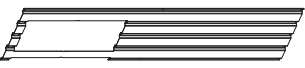
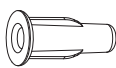
Please have the following auxiliary tools ready:





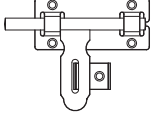

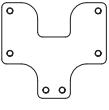
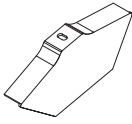

PARTS

Item no.	Reference Image	Qty.	Item no.	Reference Image	Qty.
1L		X1	7F		X2
1		X1	7B		X2
1R		X 1	8L		X1
2L		X3	8		X1
2		X1	8R		X1
2R		X3	9		X2
4B		X6	9F		X2
5		X4	9B		X2
6L		X1	10		X6
6		X1	11		X4
6R		X1	11L		X2

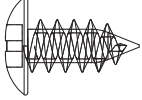
Item no.	Reference Image	Qty.	Item no.	Reference Image	Qty.
11R		X2	21L		X2
15		X4	21R		X2
16		X2	22		X1
18L		X1	23		X1
18R		X1	24		X4
18		X3	25		X4
19L		X2	26		X4
19R		X2	27		X4
19		X2	36		X1
20		X4	W3		X13
21		X4	W5		X11

Item no.	Reference Image	Qty.	Item no.	Reference Image	Qty.
W7		X4	F7		X445
W12		X16	F10		X4
W15		X4	F12		X2
M1		X2	F13		X2
C3		X1	F14		X2
C4		X1	F8		X88
C		X4	F9		X2
F		X4	S1		X1
I		X6	S2		X1
F4		X4	S3		X1
F5		X2	S4		X506

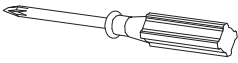
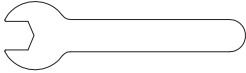
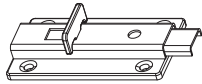
Item no.	Reference Image	Qty.
S6		X139
S7		X117
S8		X8
S9		X4



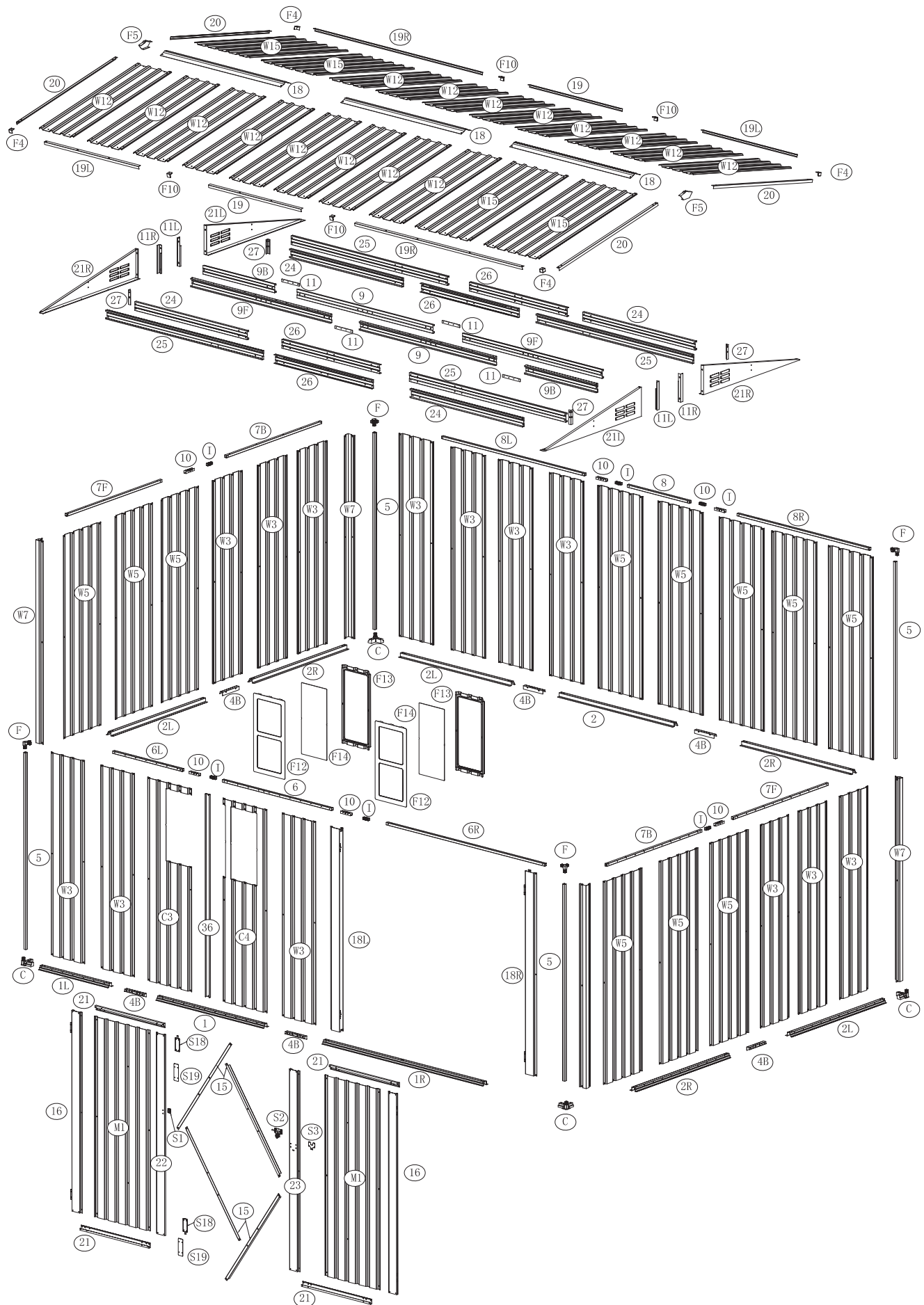

Item no.	Reference Image	Qty.
S12		X1
S15		X1
S18		X2
S19		X2

EXPLODED VIEW





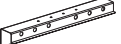

ASSEMBLY

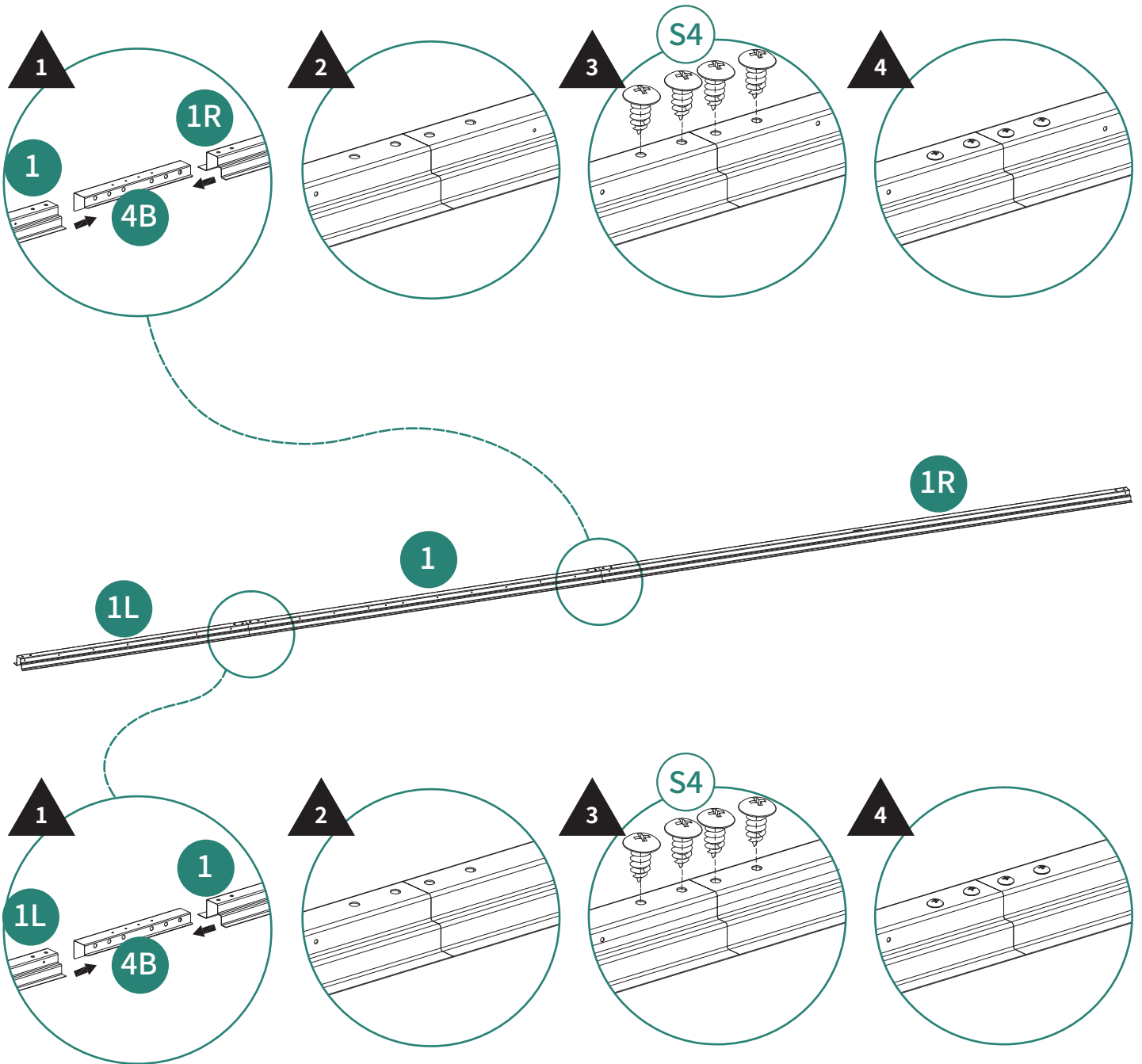
1

-  ①L 1pc
-  ① 1pc
-  ①R 1pc
-  ④B 2pcs
-  ④S 8pcs



2 <hr style="border: 0; border-top: 1px solid white;"/> X2	   
	2L 2pcs 2R 2pcs 4B 2pcs S4 8pcs

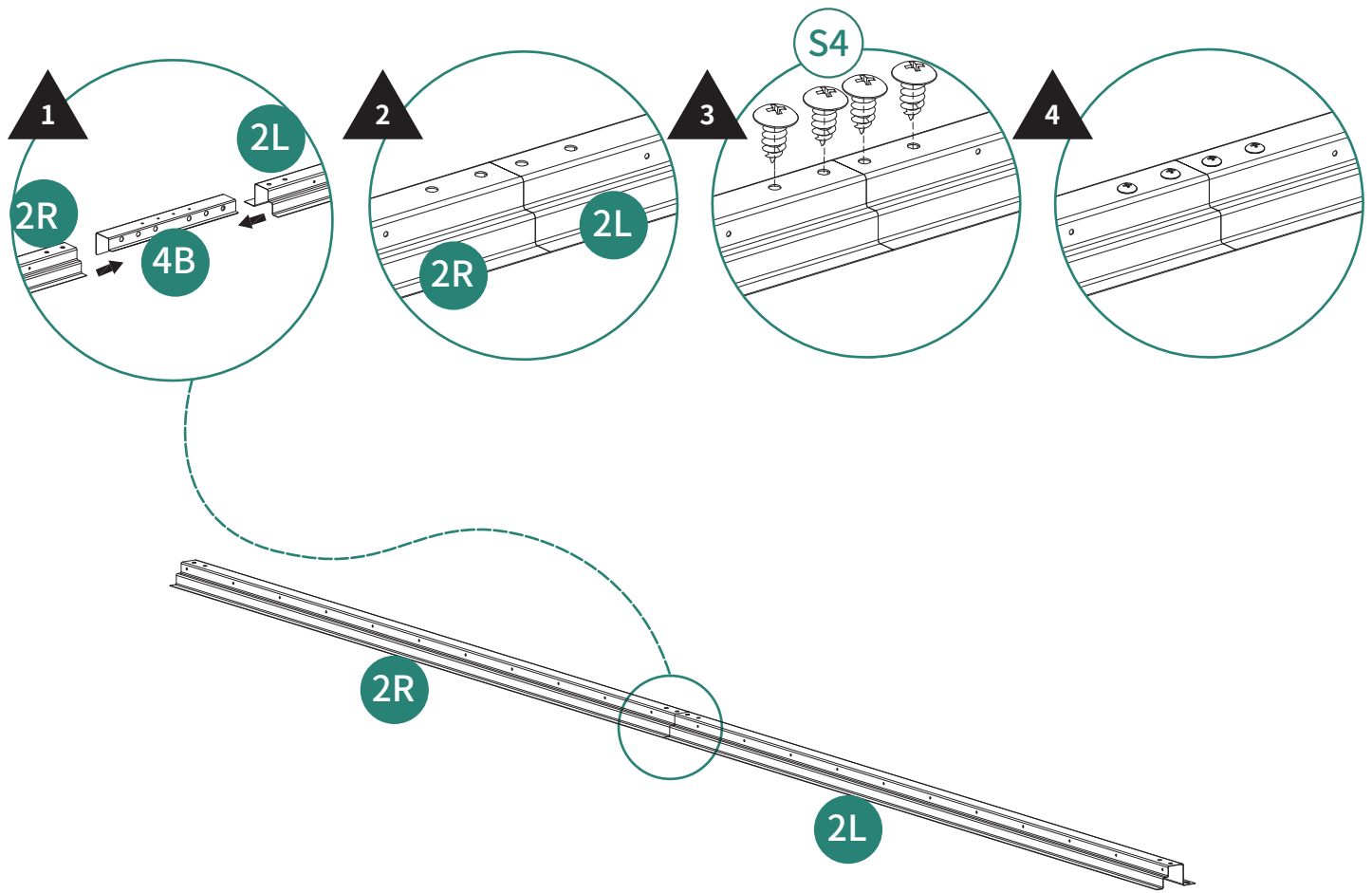

3



①L1pc



①1pc



①R1pc

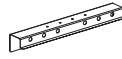



④B2pcs

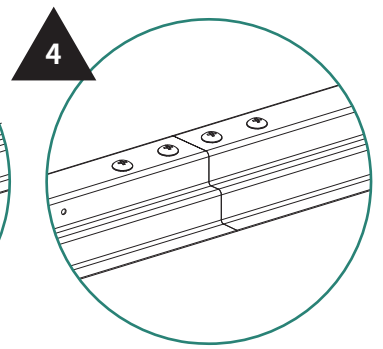
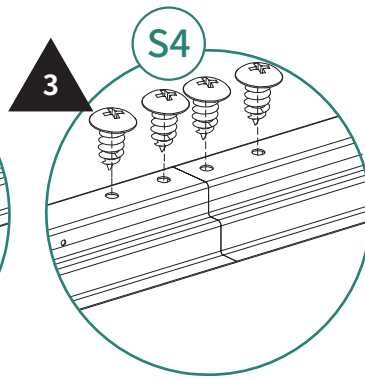
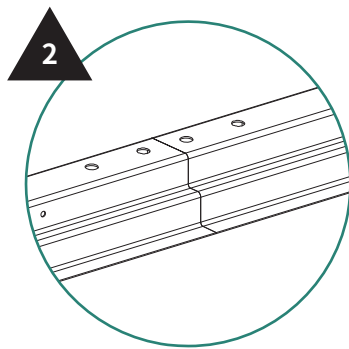
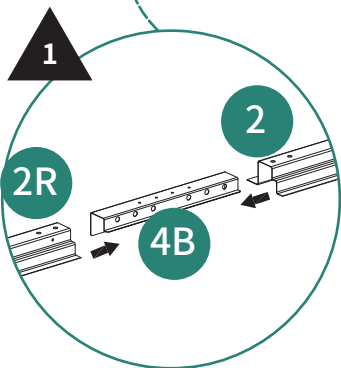
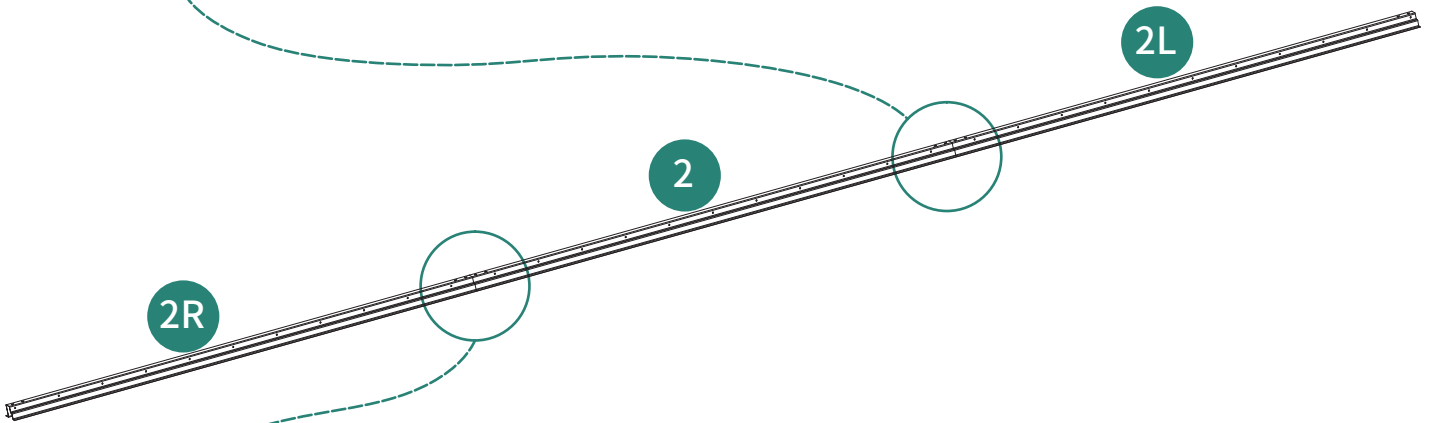
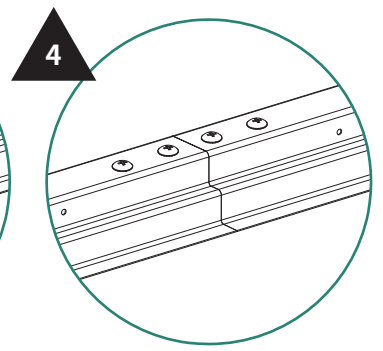
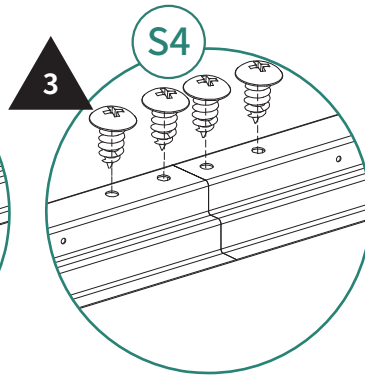
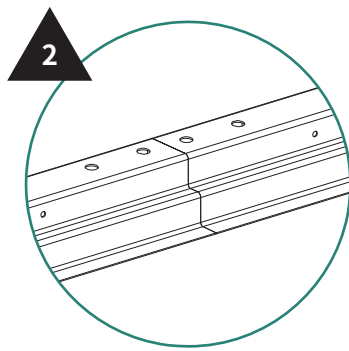
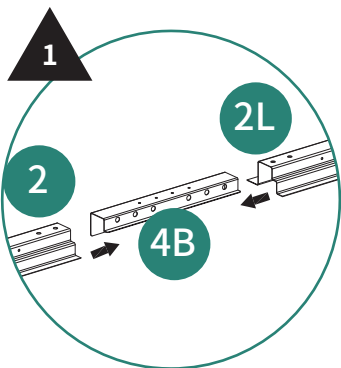

④S48pcs



4



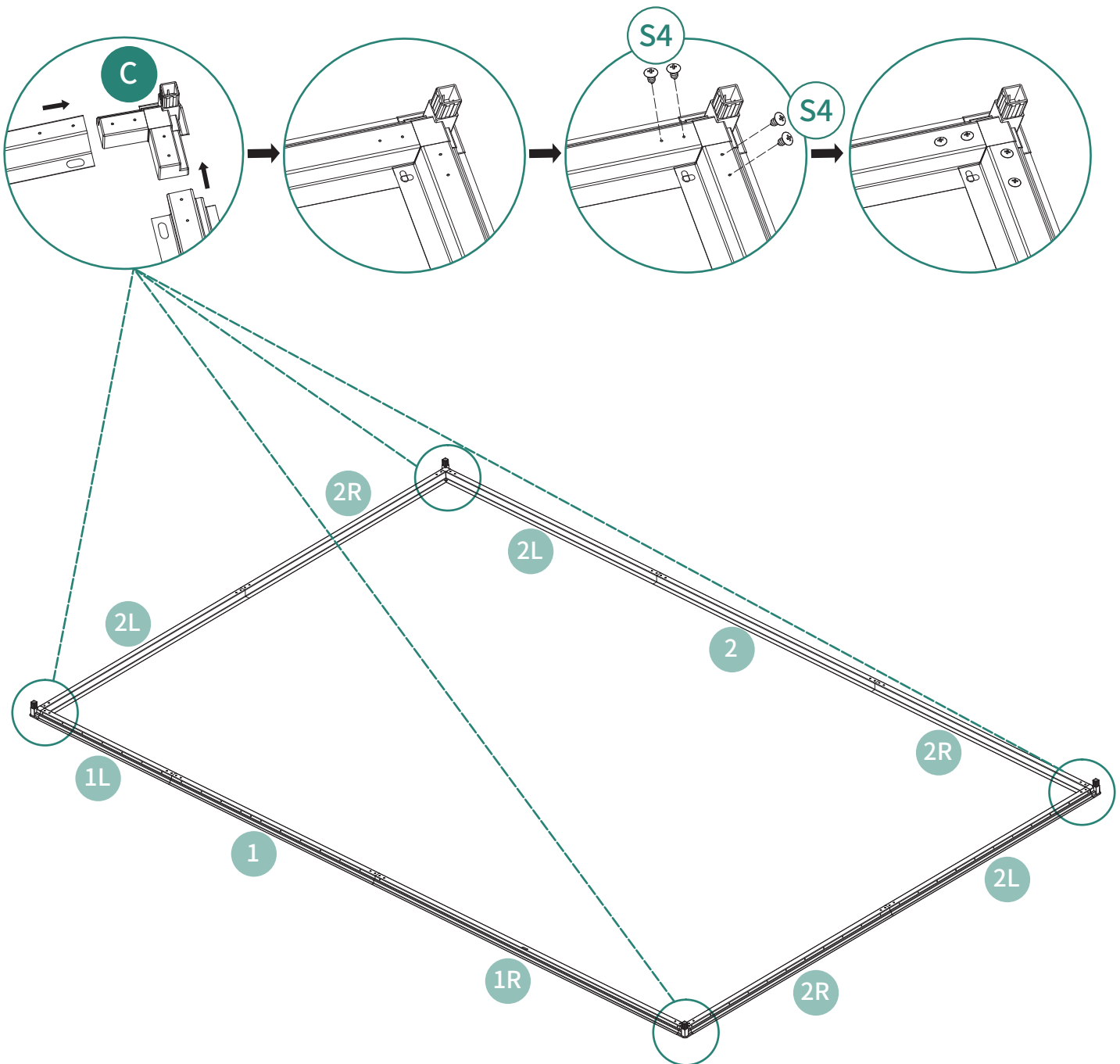

 
C 4pcs S4 16pcs

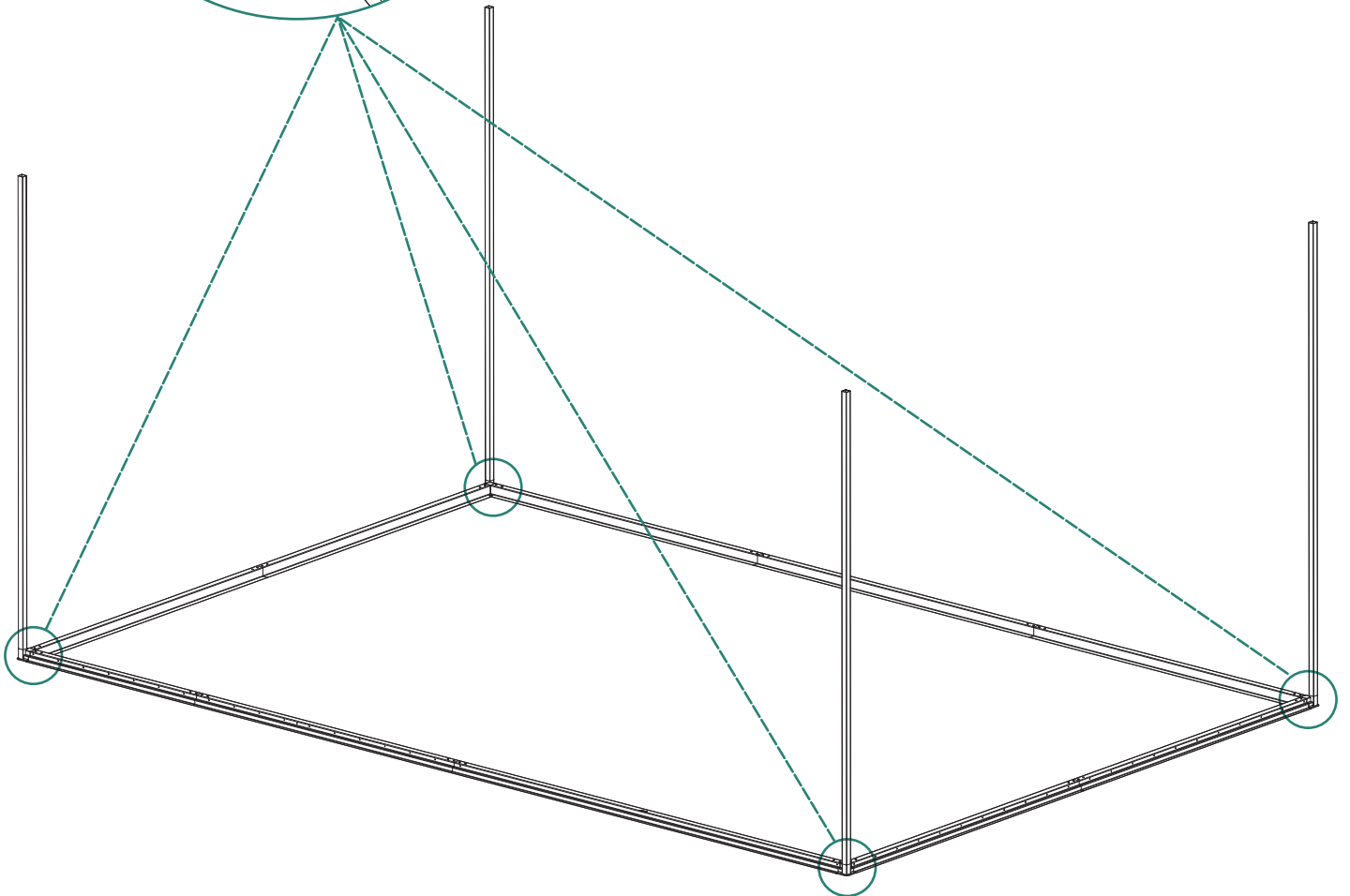
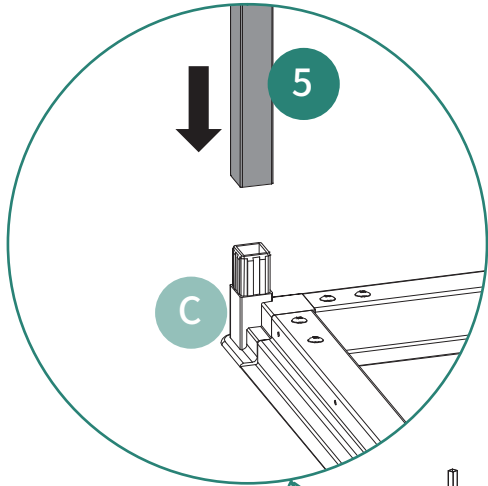
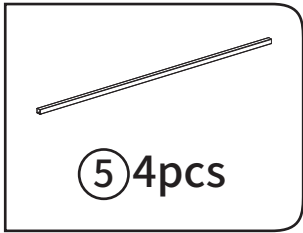

5

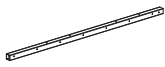
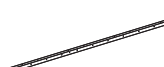

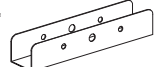
6

-  ⑥L 1pc
-  ⑥ 1pc
-  ⑥R 1pc
-  ⑩ 2pcs
-  ① 2pcs
-  ④ 8pcs

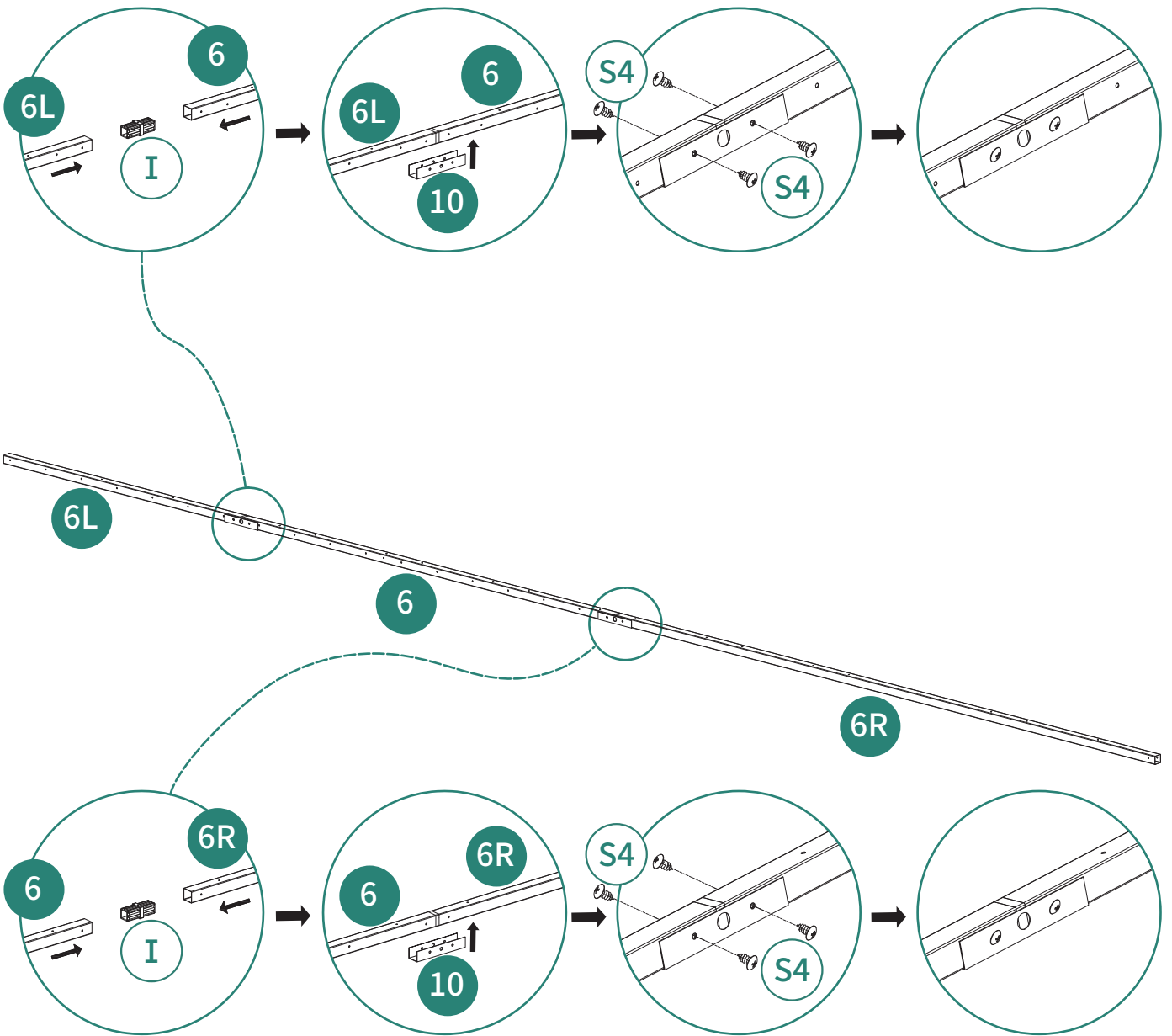

7
X2

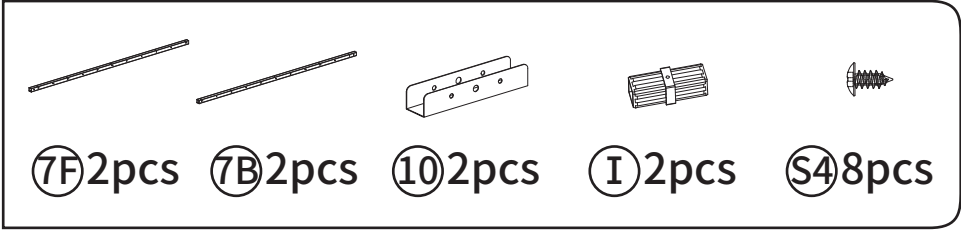



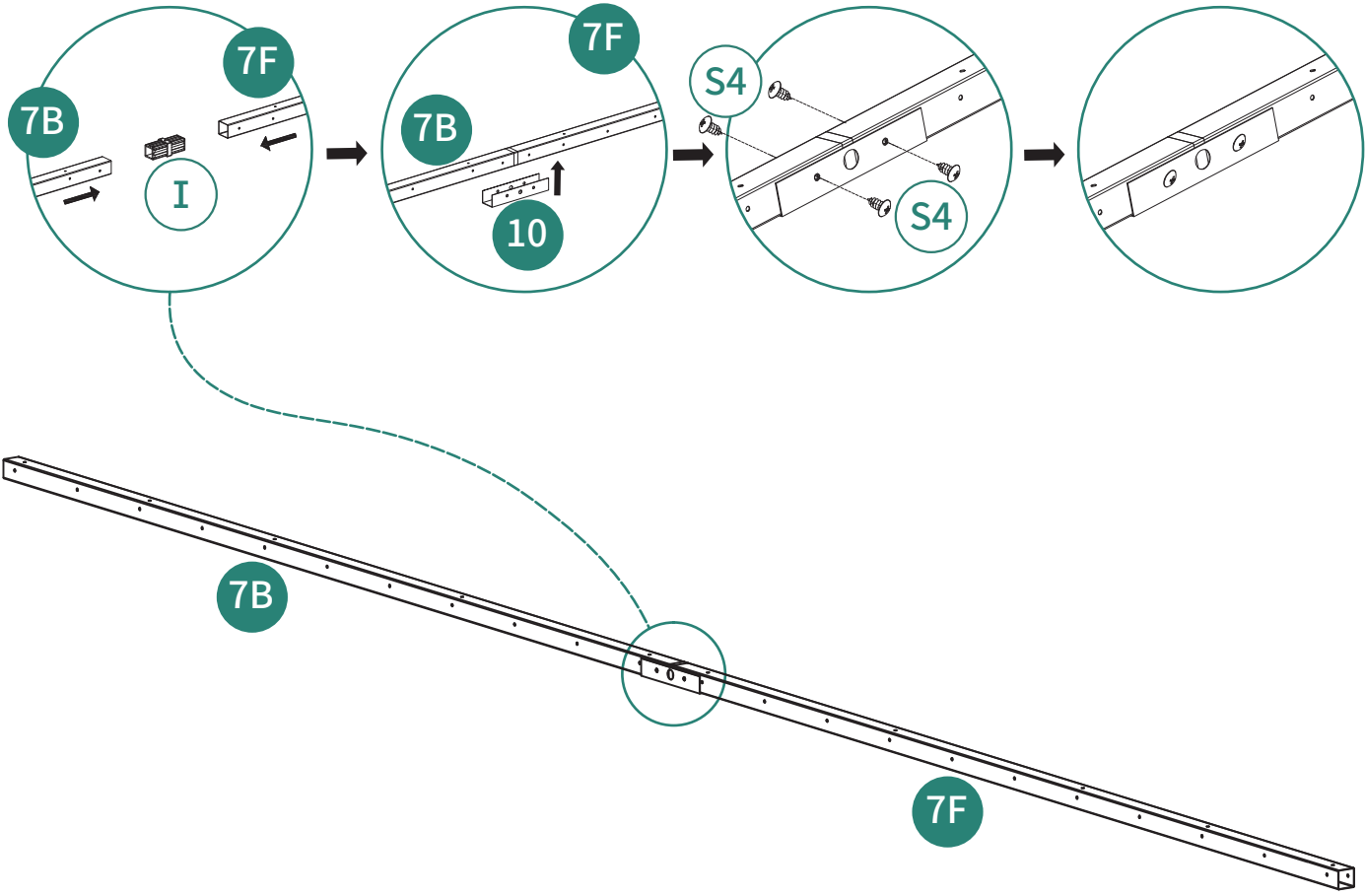

7F 2pcs 7B 2pcs 10 2pcs I 2pcs S4 8pcs

This block contains a parts list for step 7. It includes five items with their respective quantities: 7F (2 pieces), 7B (2 pieces), 10 (2 pieces), I (2 pieces), and S4 (8 pieces). Each item is accompanied by a small line drawing of the component.

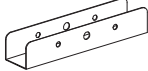

8

-  ⑧L 1pc
-  ⑧ 1pc
-  ⑧R 1pc
-  ⑩ 2pcs
-  I 2pcs
-  S4 8pcs

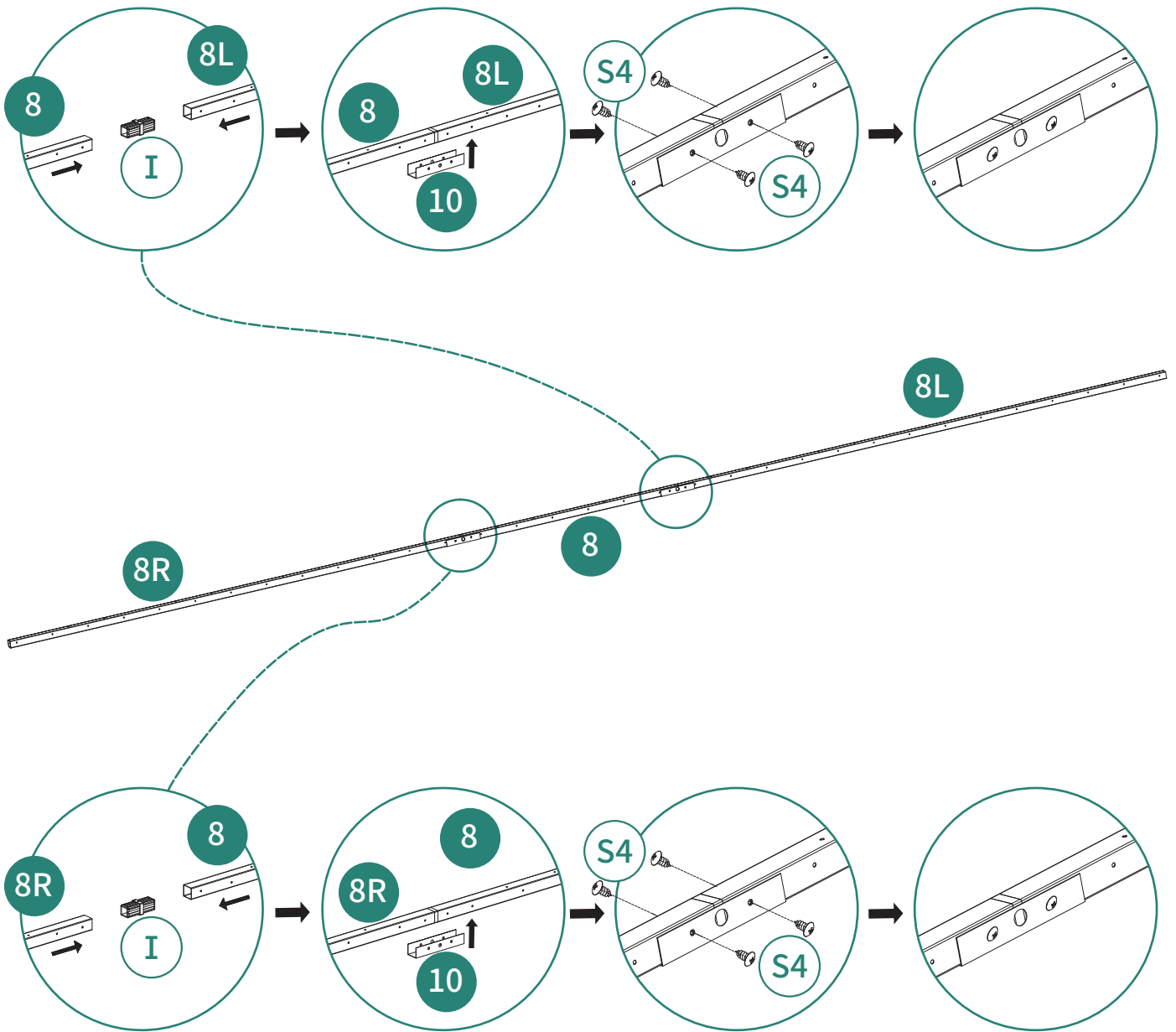

9



F 4pcs S4 8pcs

NOTES:

When assembling the beam:

1. Make sure parts (7B, 7F, 8L, 8, 8R) have the sides with closely spaced holes facing outward, and the sides with widely spaced holes facing upward.
2. Ensure parts (6L, 6, 6R) have the sides with rectangular latch lock slot facing downward. Part 6L should be on the left side and part 6R on the right.

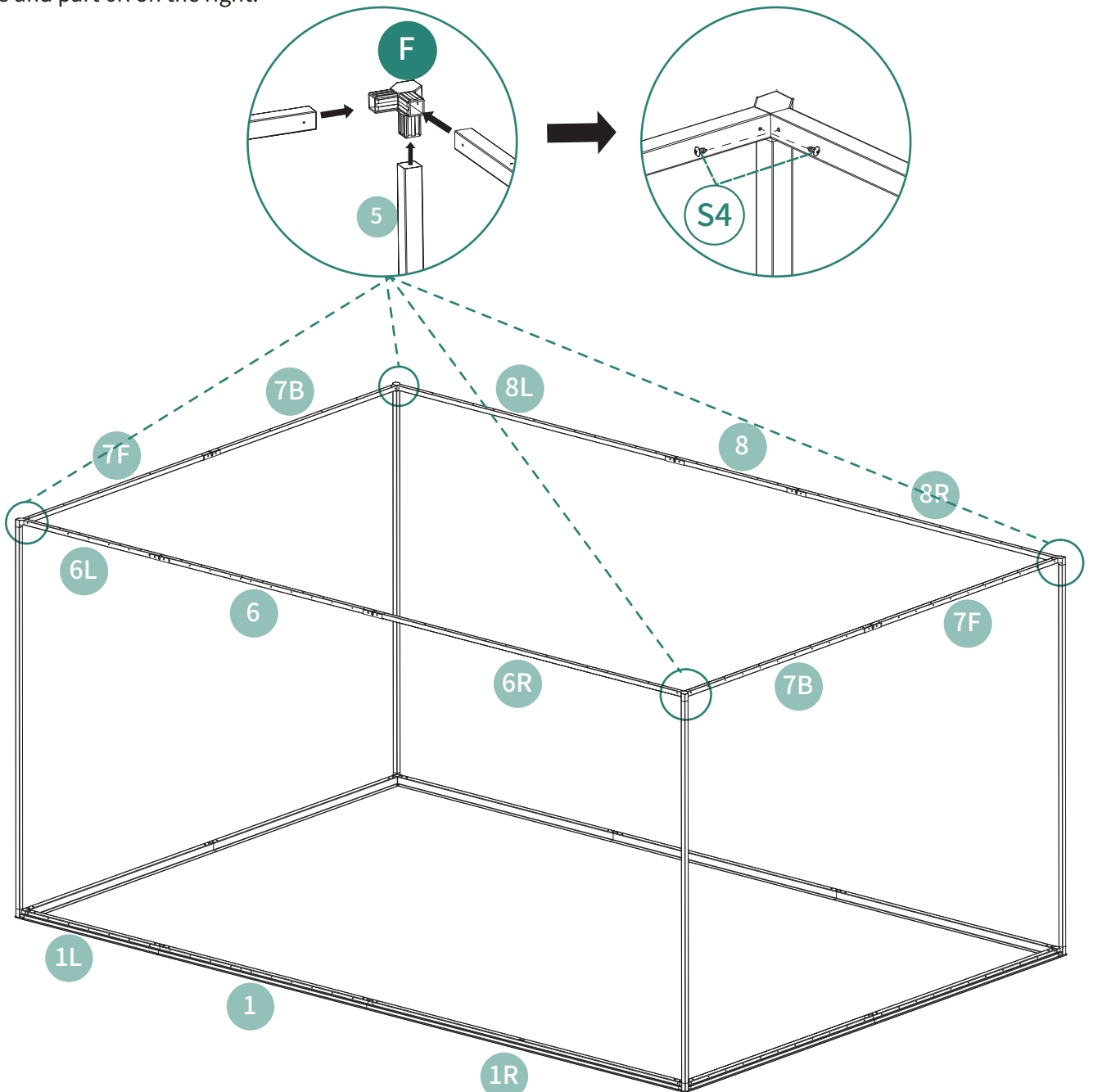

10



W3 3pcs W5 3pcs W7 2pcs S4 44pcs S6 7pcs S7 7pcs F7 51pcs

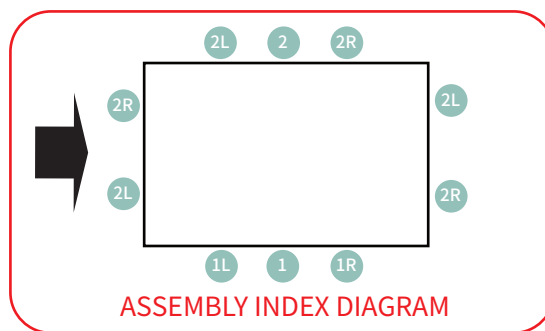
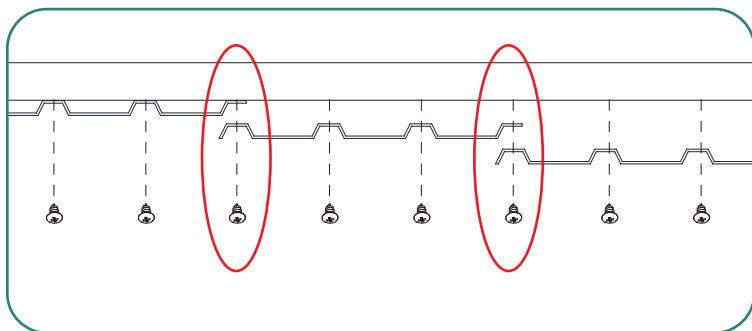

When fixing the screws, leave the screws on both sides of the component unfastened. Wait until the adjacent component is installed, and then once the two components are overlapped, secure the screws.

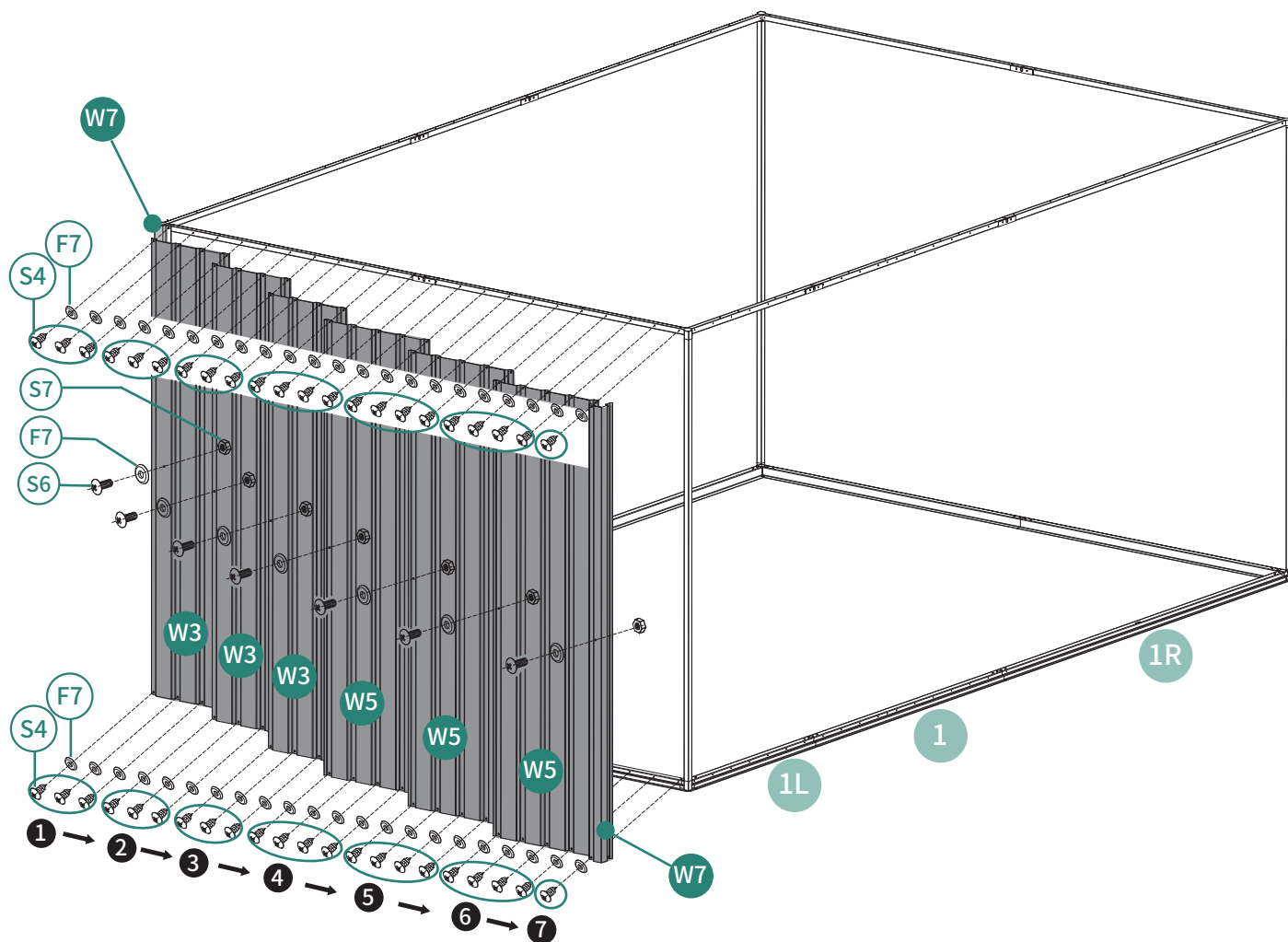

Fasten the screws according to the numerical order.

11

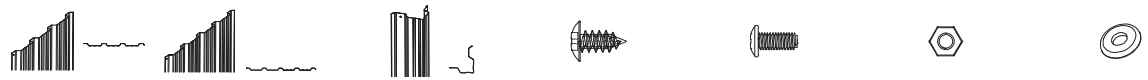

W3 3pcs W5 3pcs W7 2pcs S4 44pcs S6 7pcs S7 7pcs F7 51pcs

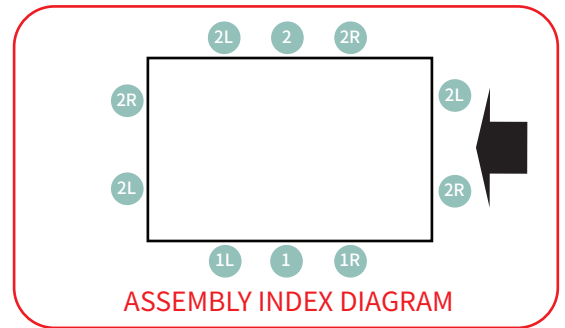
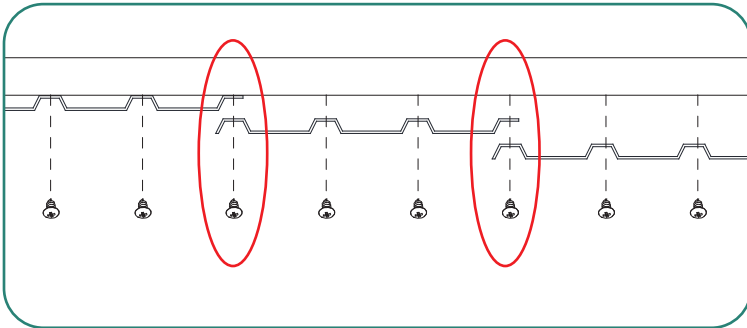

When fixing the screws, leave the screws on both sides of the component unfastened. Wait until the adjacent component is installed, and then once the two components are overlapped, secure the screws.

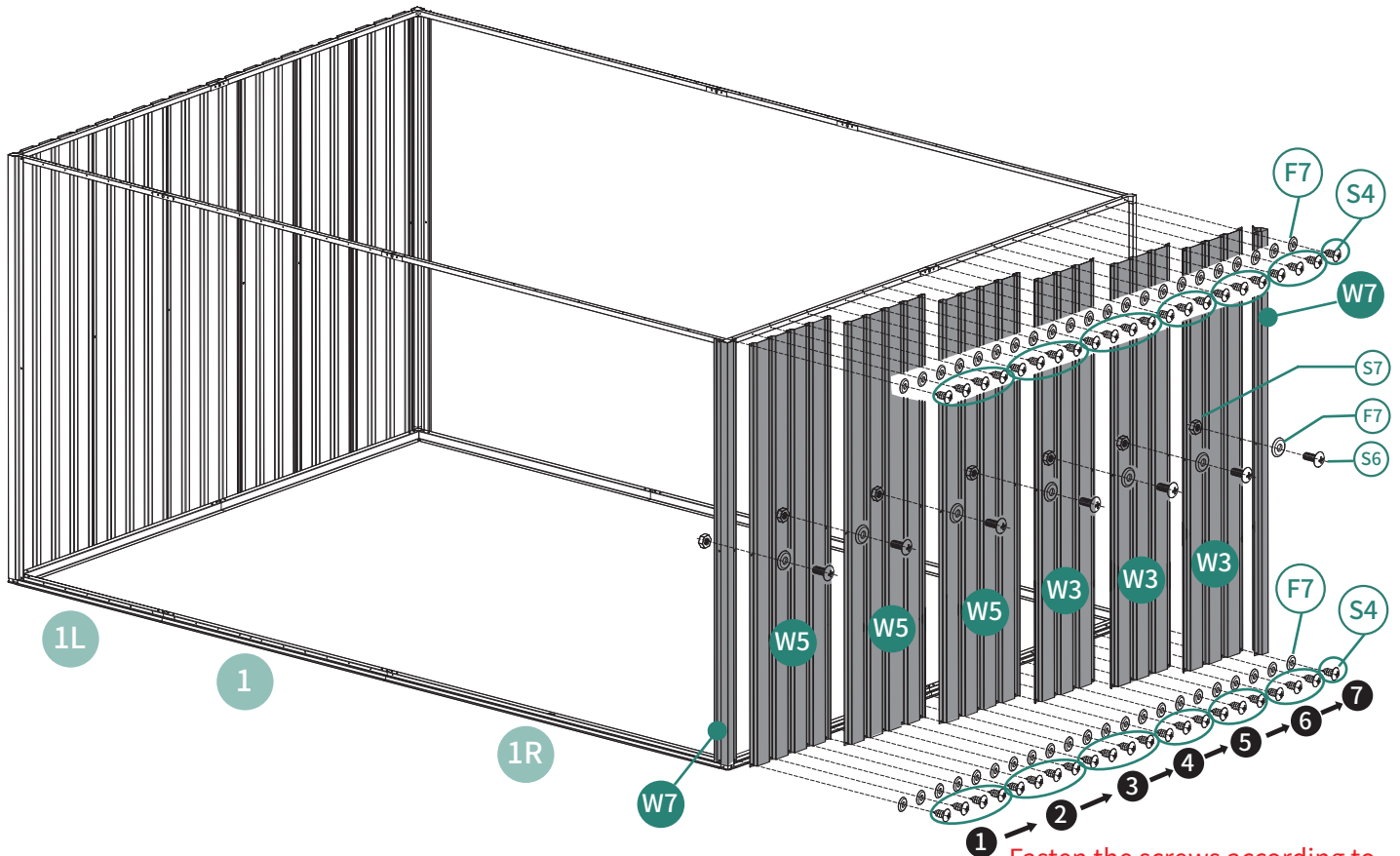

Fasten the screws according to the numerical order.

12



W3 4pcs W5 5pcs S4 66pcs S6 10pcs S7 10pcs F7 76pcs

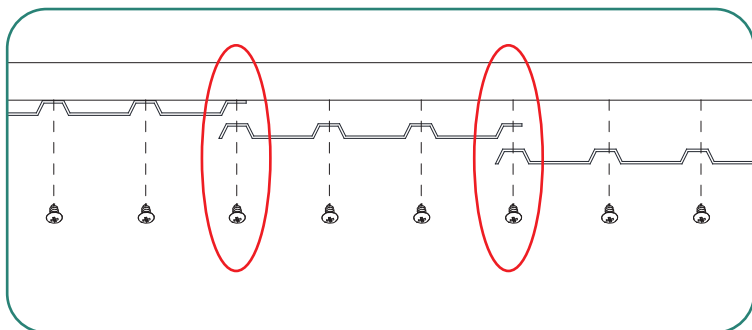

When fixing the screws, leave the screws on both sides of the component unfastened. Wait until the adjacent component is installed, and then once the two components are overlapped, secure the screws.

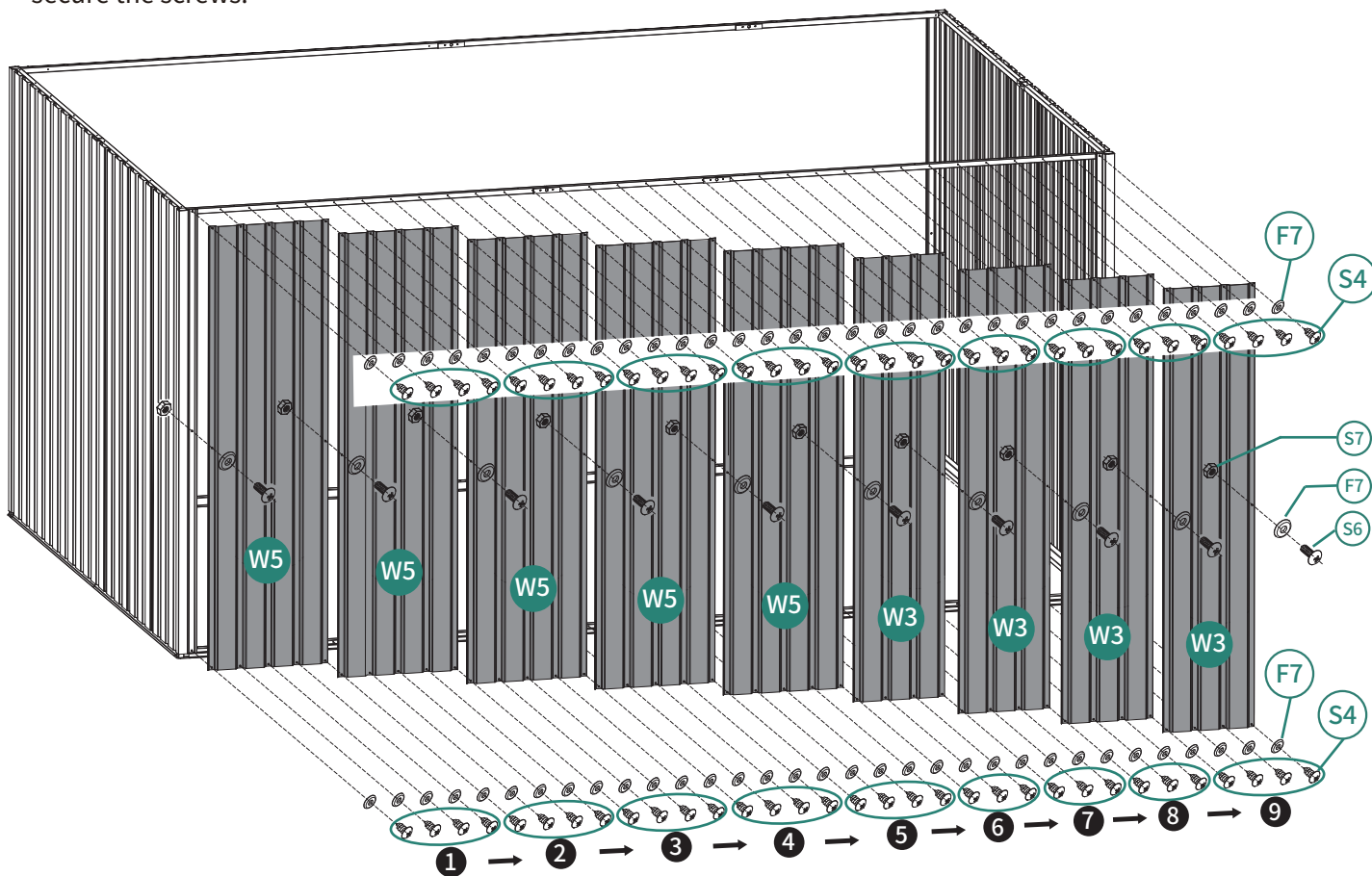
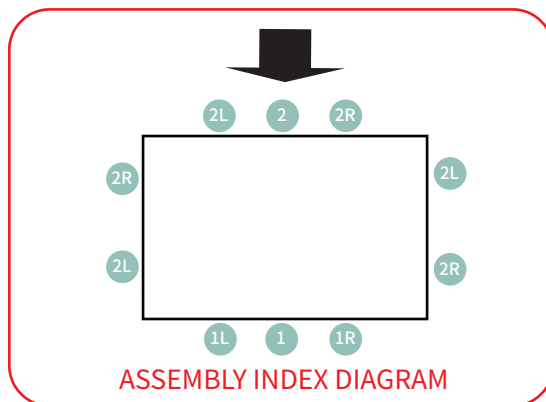

Fasten the screws according to the numerical order.

13

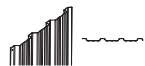

③⑥ 1pc

①③ 2pcs

①④ 14pcs

①⑥ 2pcs

①⑦ 2pcs

①⑦ 14pcs

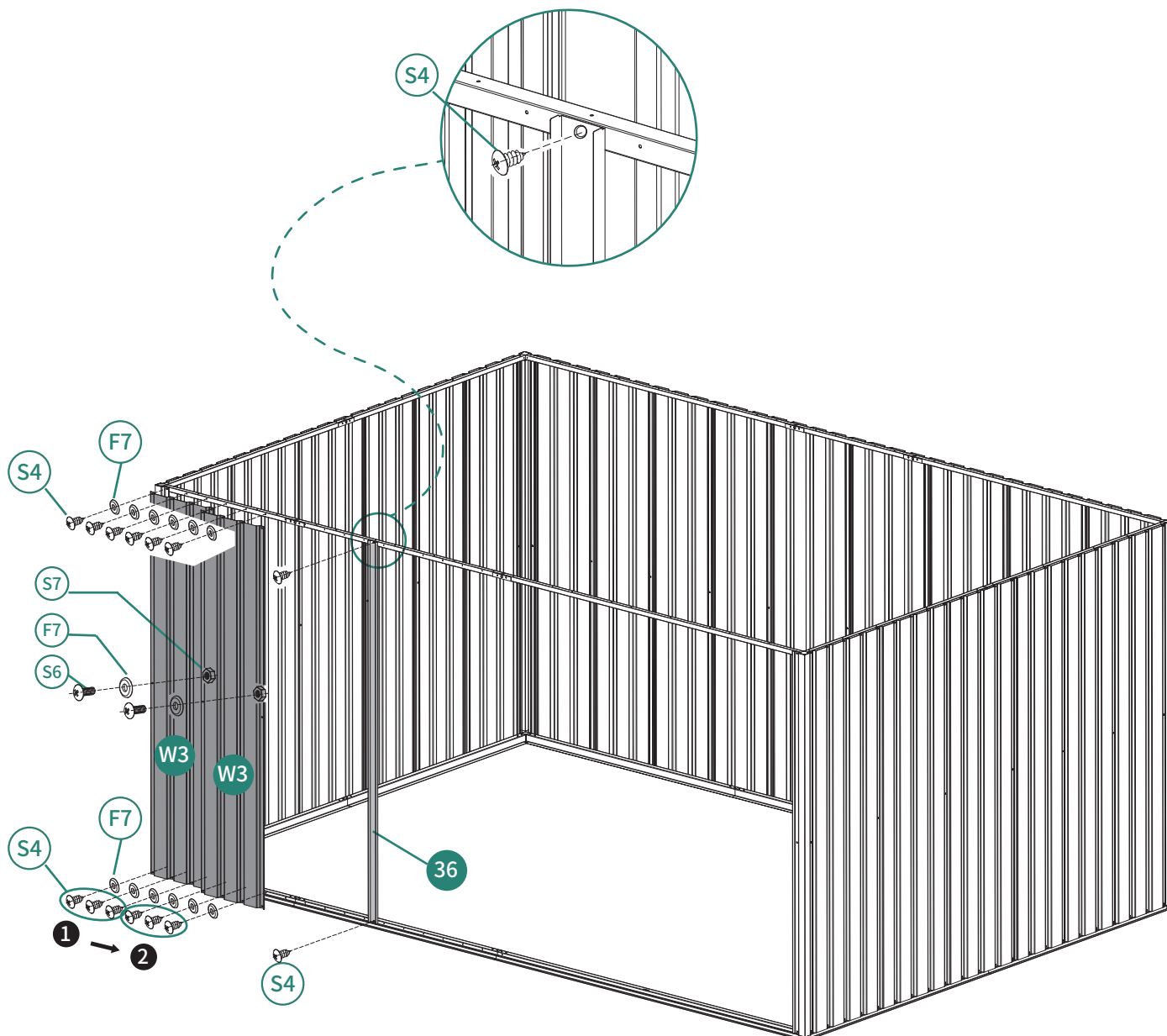

14



18L 1pc 18R 1pc C3 1pc C4 1pc W3 1pc S4 30pcs S6 5pcs S7 5pcs F7 31pcs

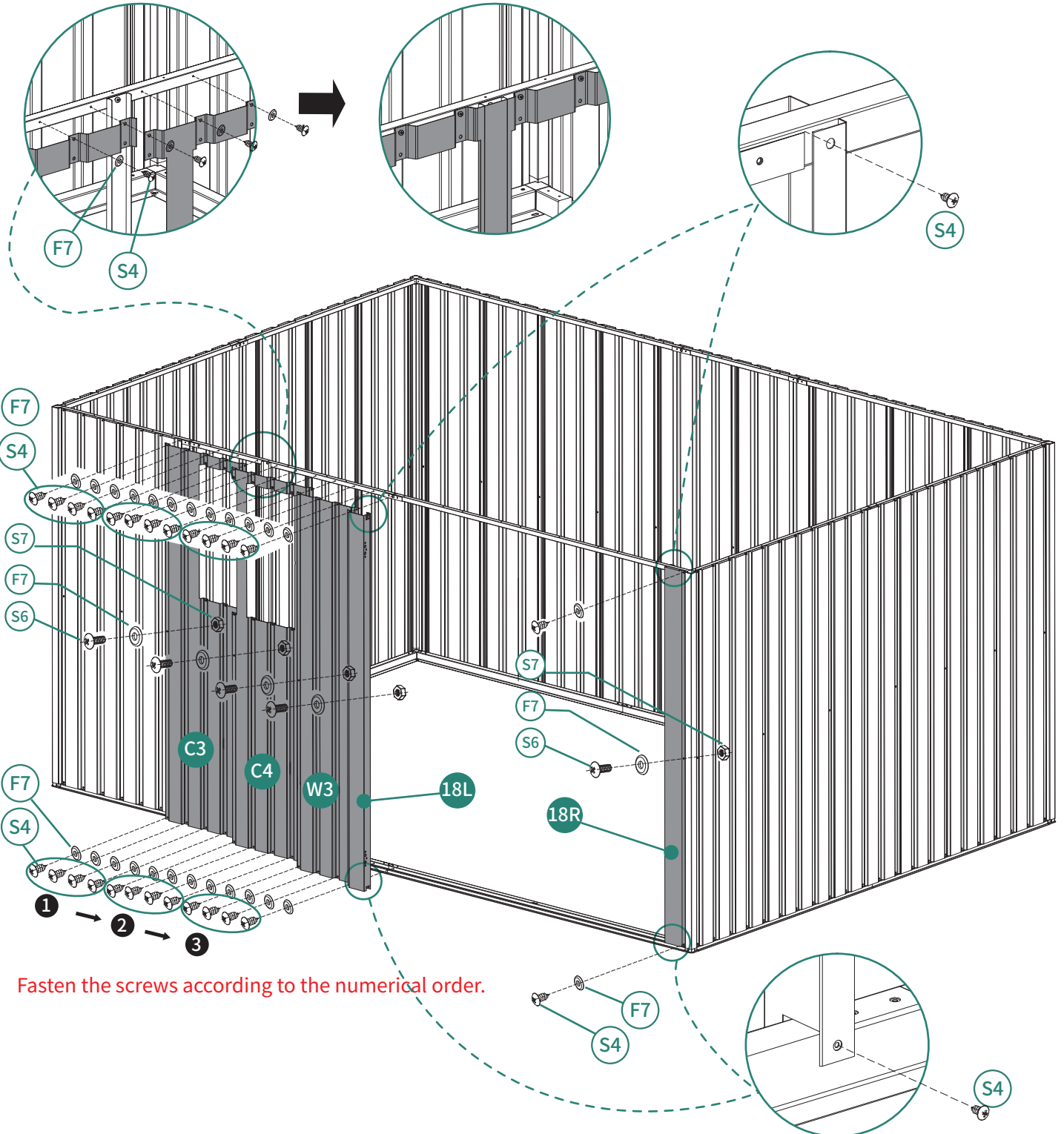

15

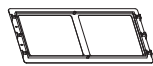

F12 2pcs

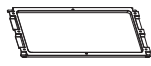

F13 2pcs

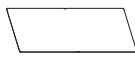

F14 2pcs



S4 16pcs

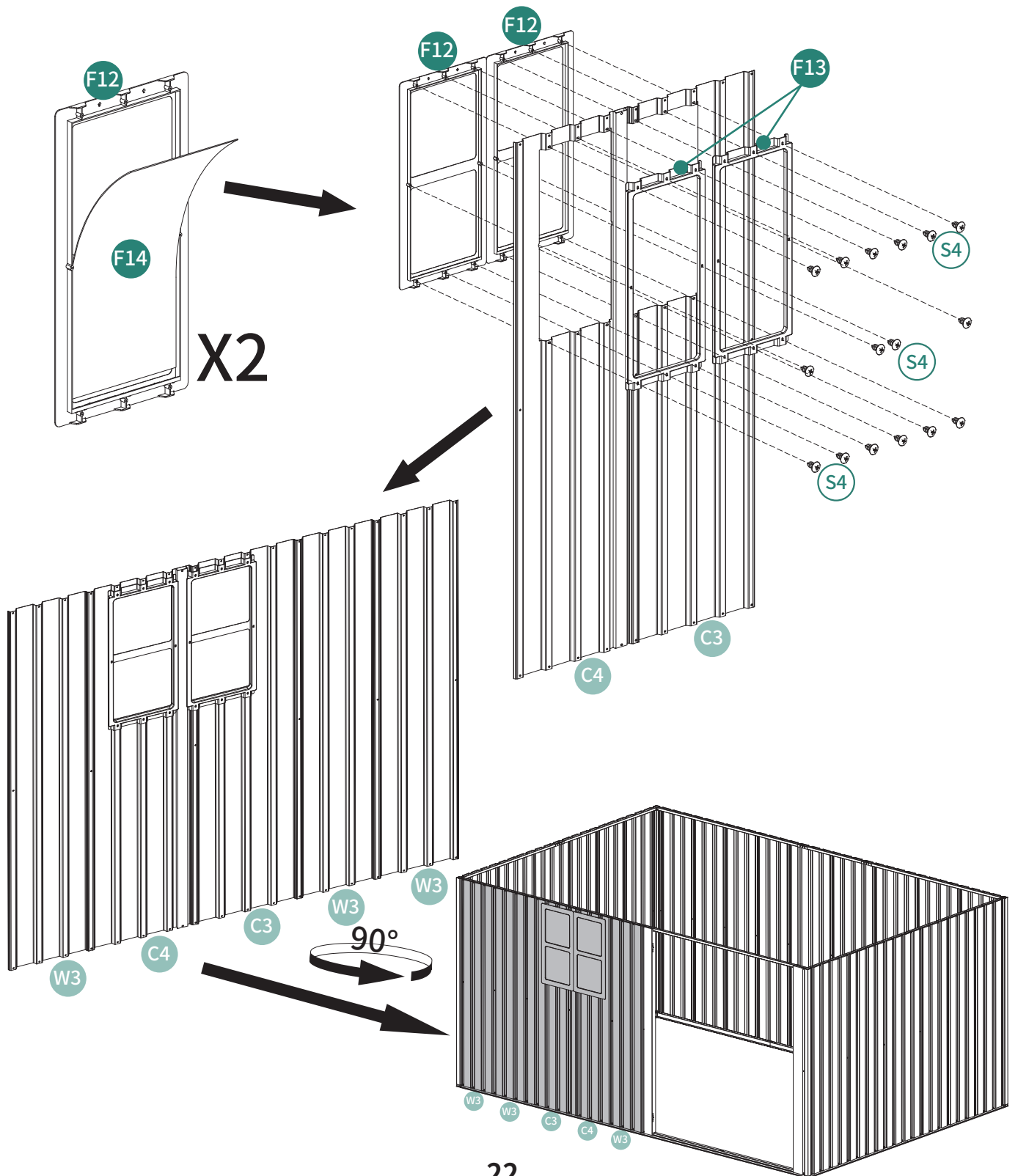

16
X2



11L 2pcs 11R 2pcs 21L 2pcs 21R 2pcs S6 2pcs S7 2pcs

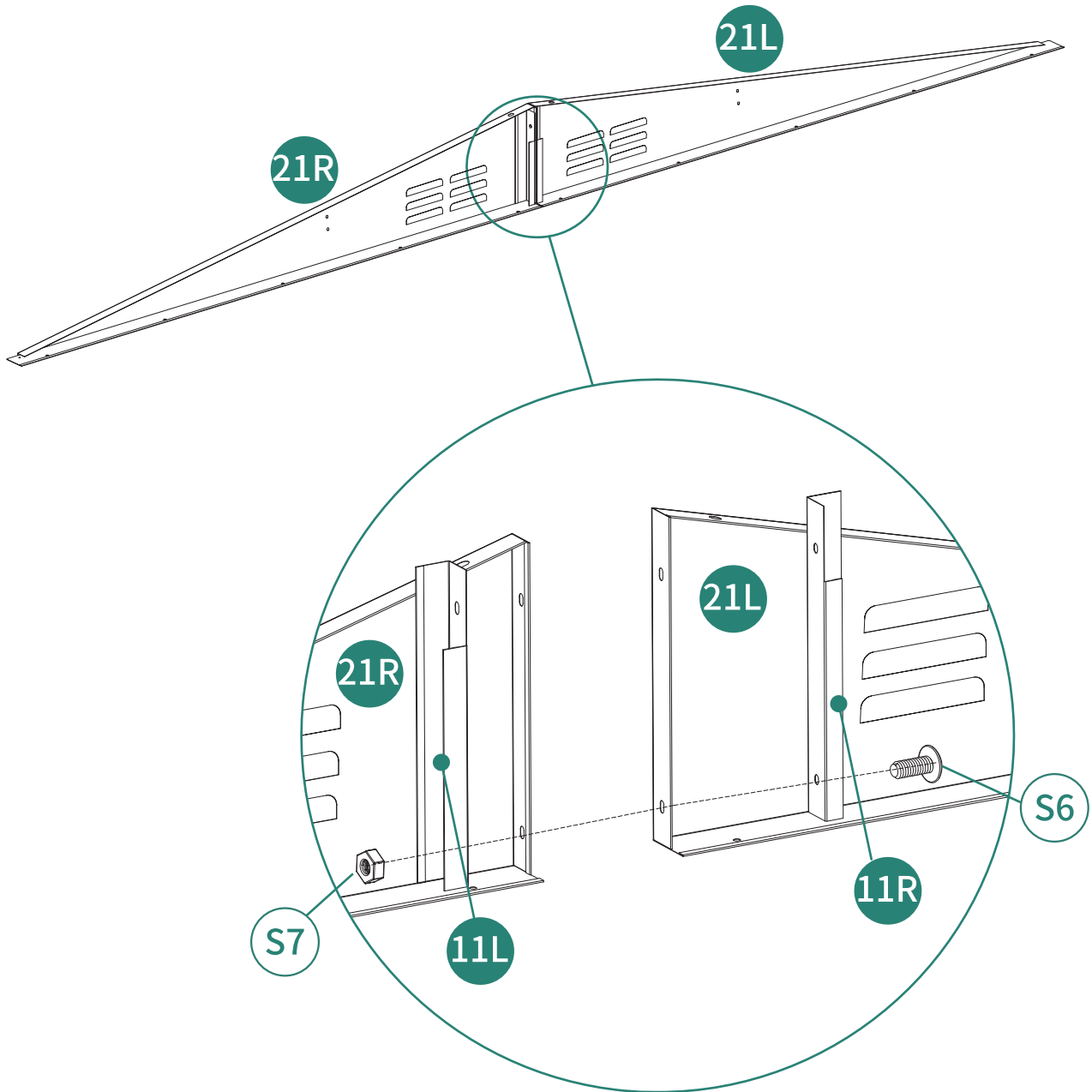

17

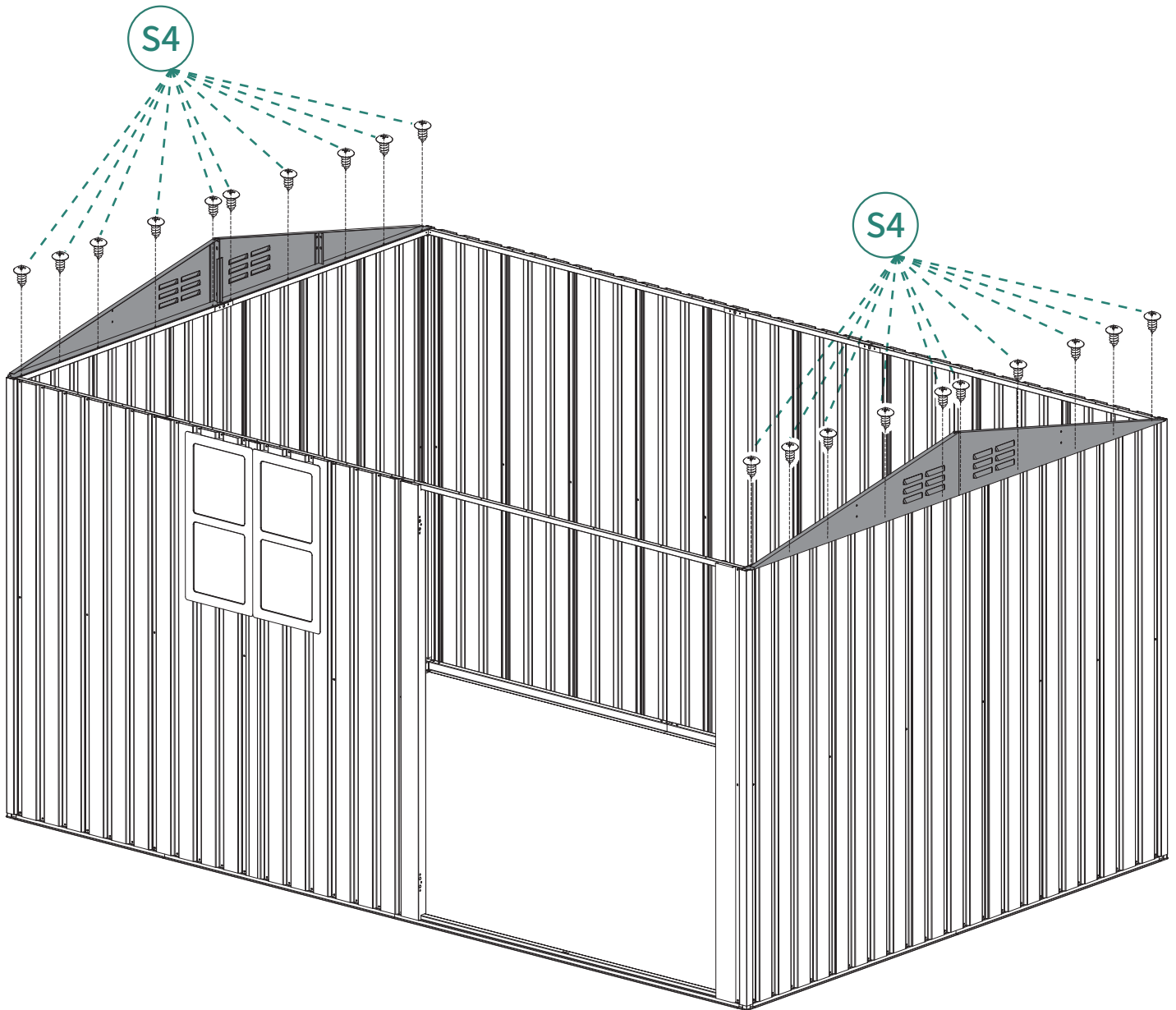
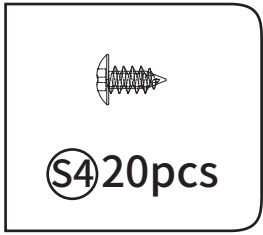

18



⑨ 2pcs



⑨F 2pcs



⑨B 2pcs



⑪ 4pcs



⑆S6 16pcs

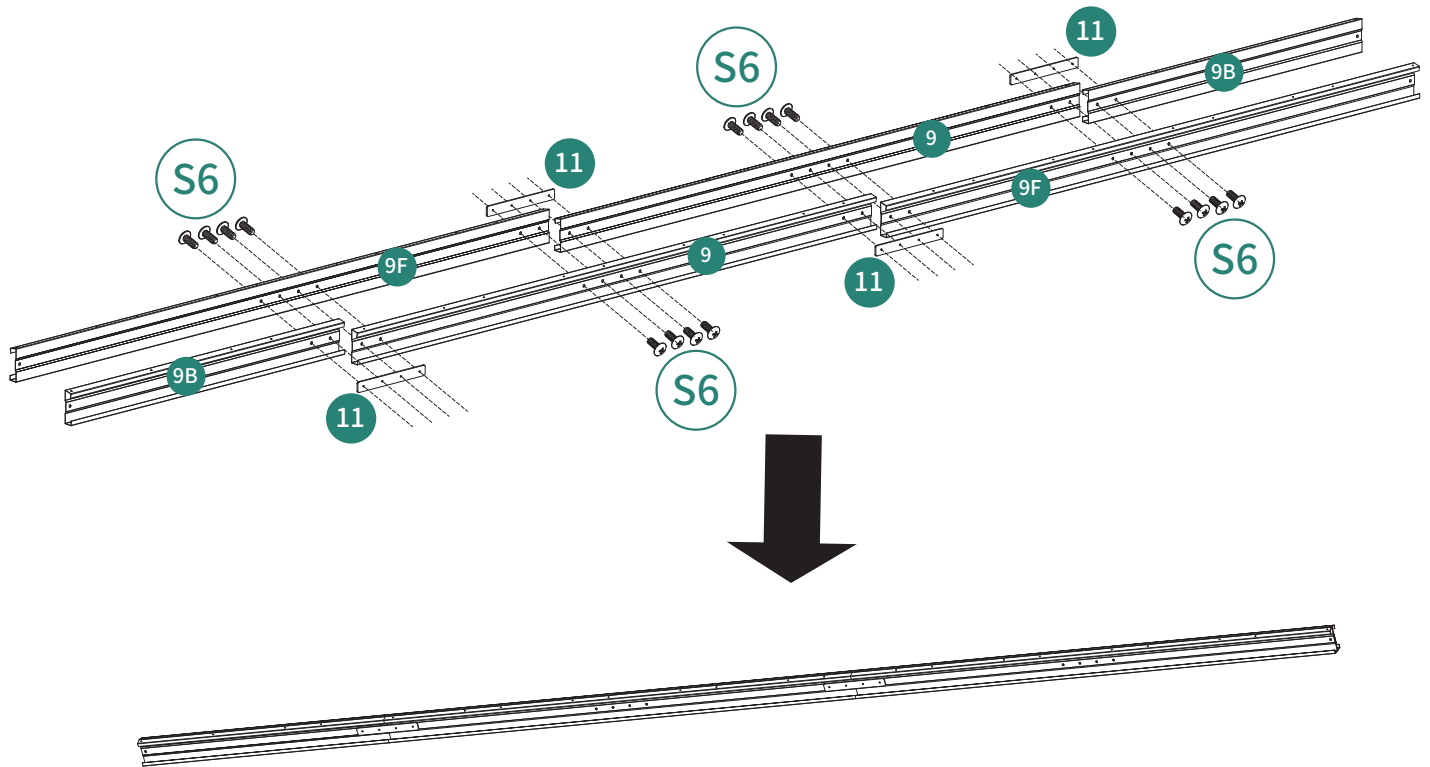

19



S6 2pcs



S7 2pcs

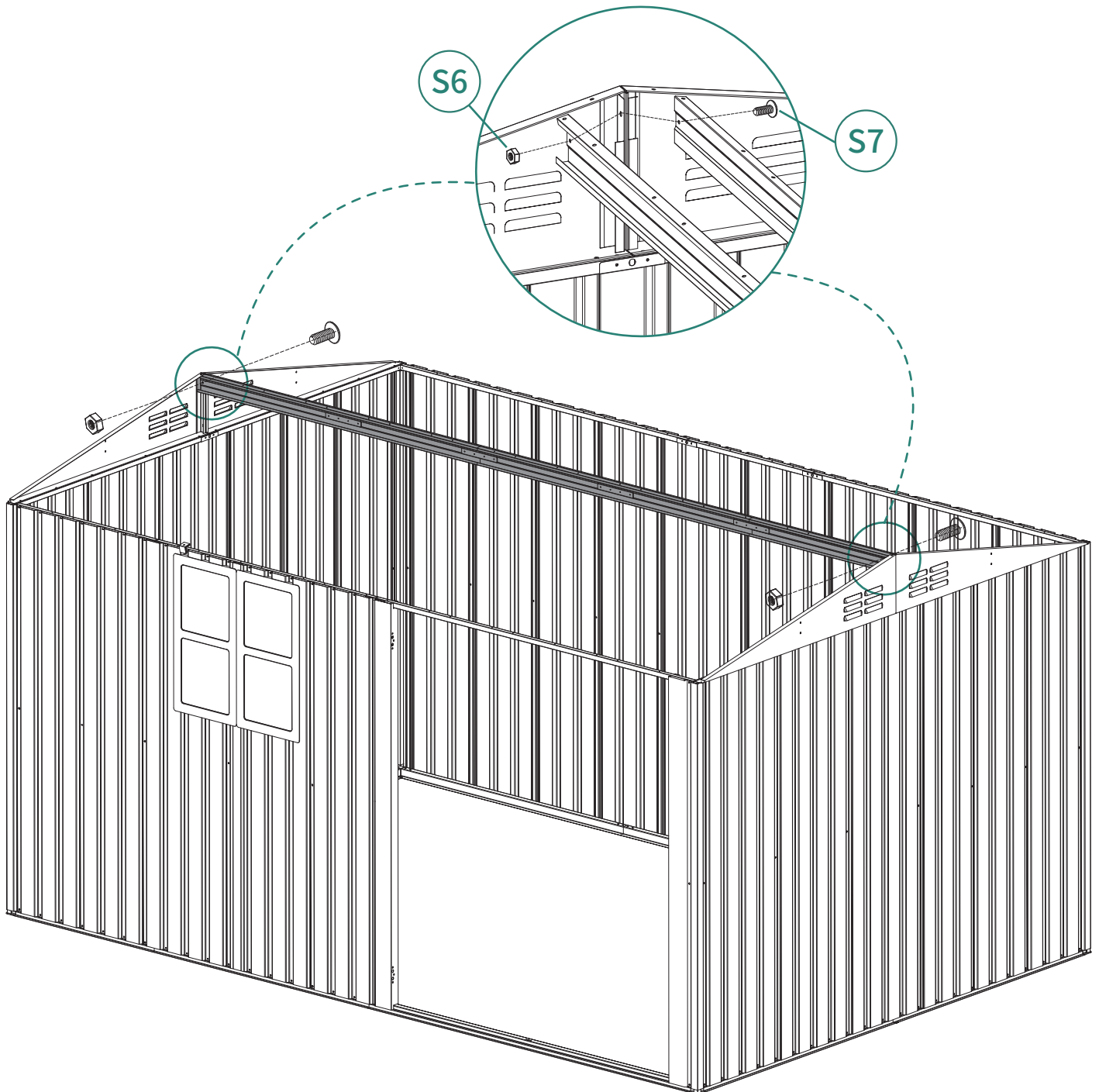

20

X2

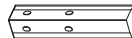

②4 4pcs

②5 4pcs

②6 4pcs

②7 4pcs

②S6 40pcs

②S7 40pcs

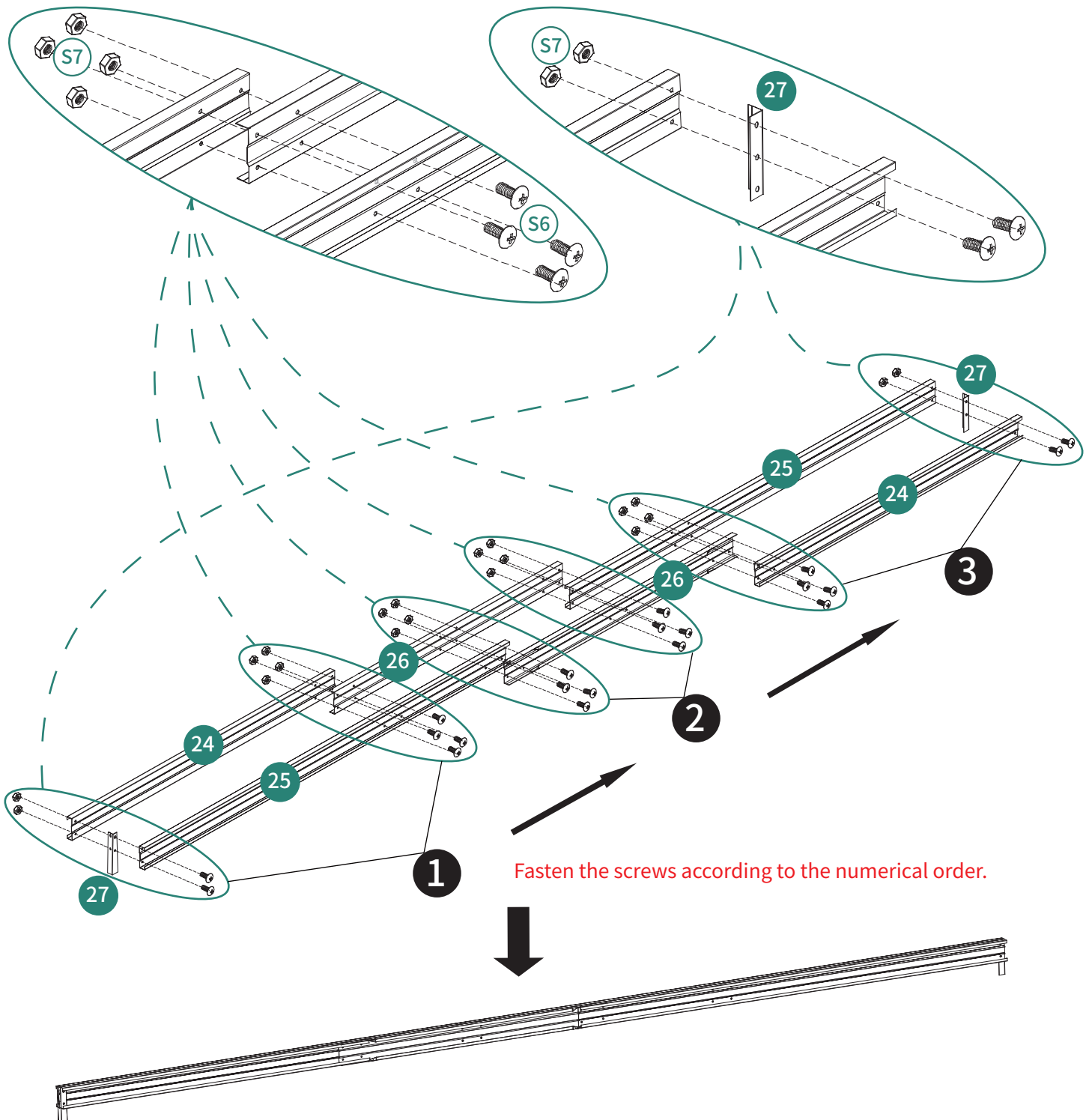

21



S6 8pcs



S7 8pcs



F7 8pcs

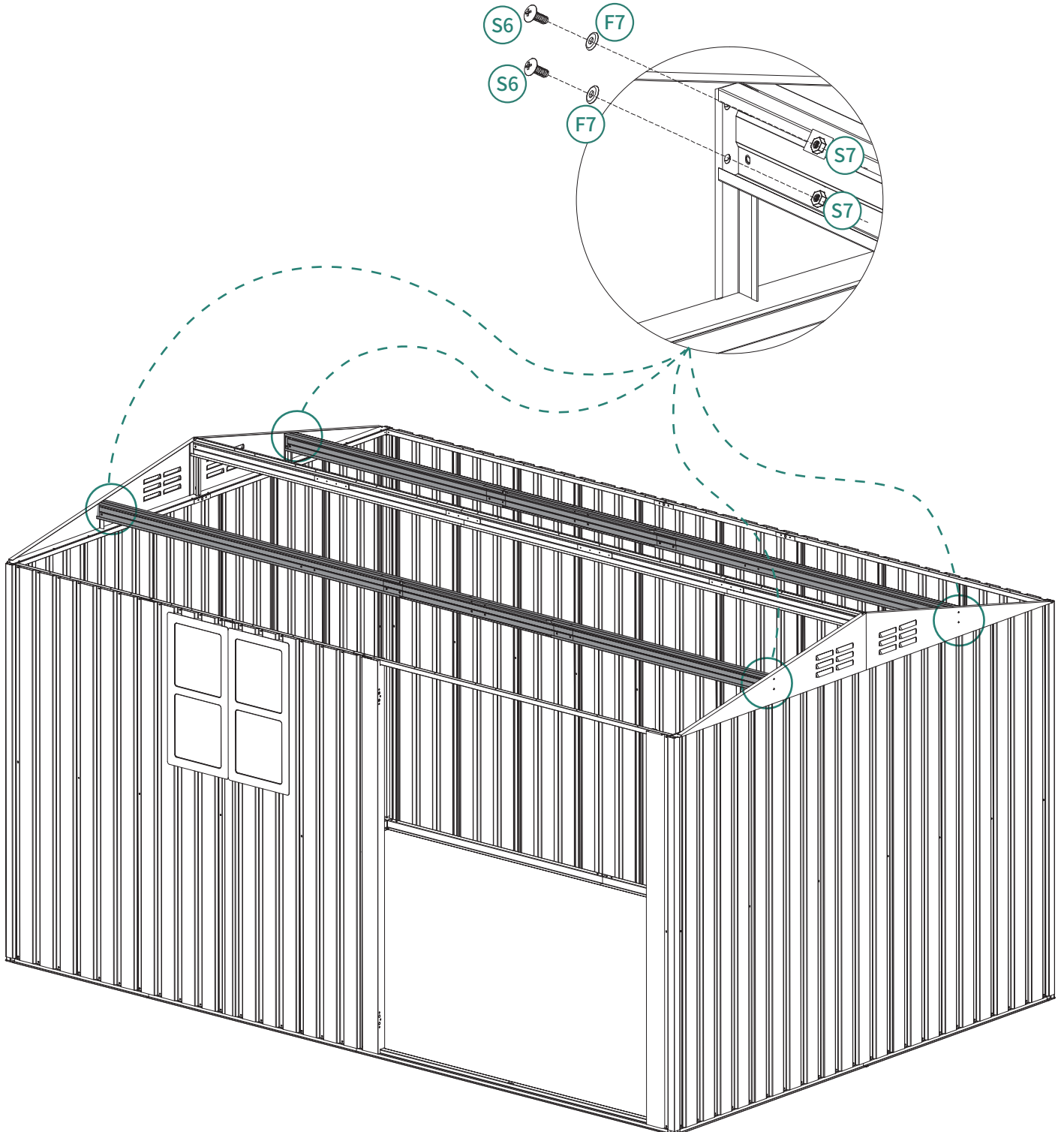
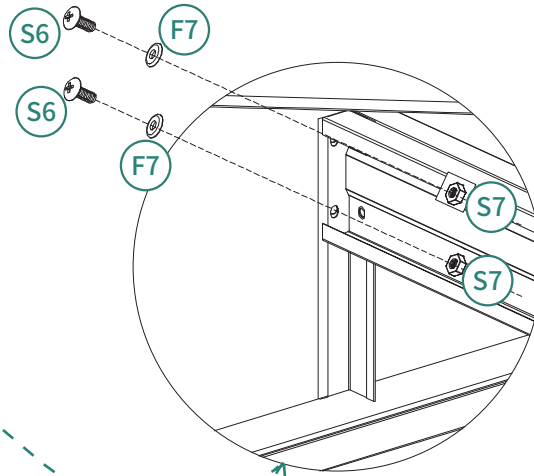

22

W12 16 pcs W15 4 pcs S4 142 pcs F7 142 pcs

22-1

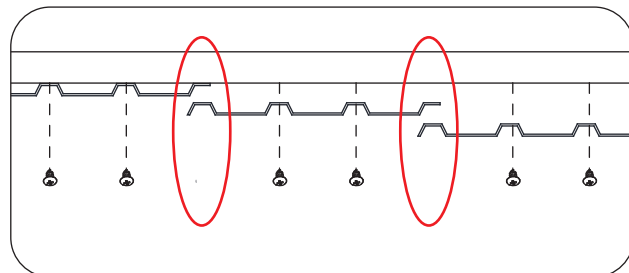

When fixing the screws, leave the screws on both sides of the component unfastened. Wait until the adjacent component is installed, and then once the two components are overlapped, secure the screws.

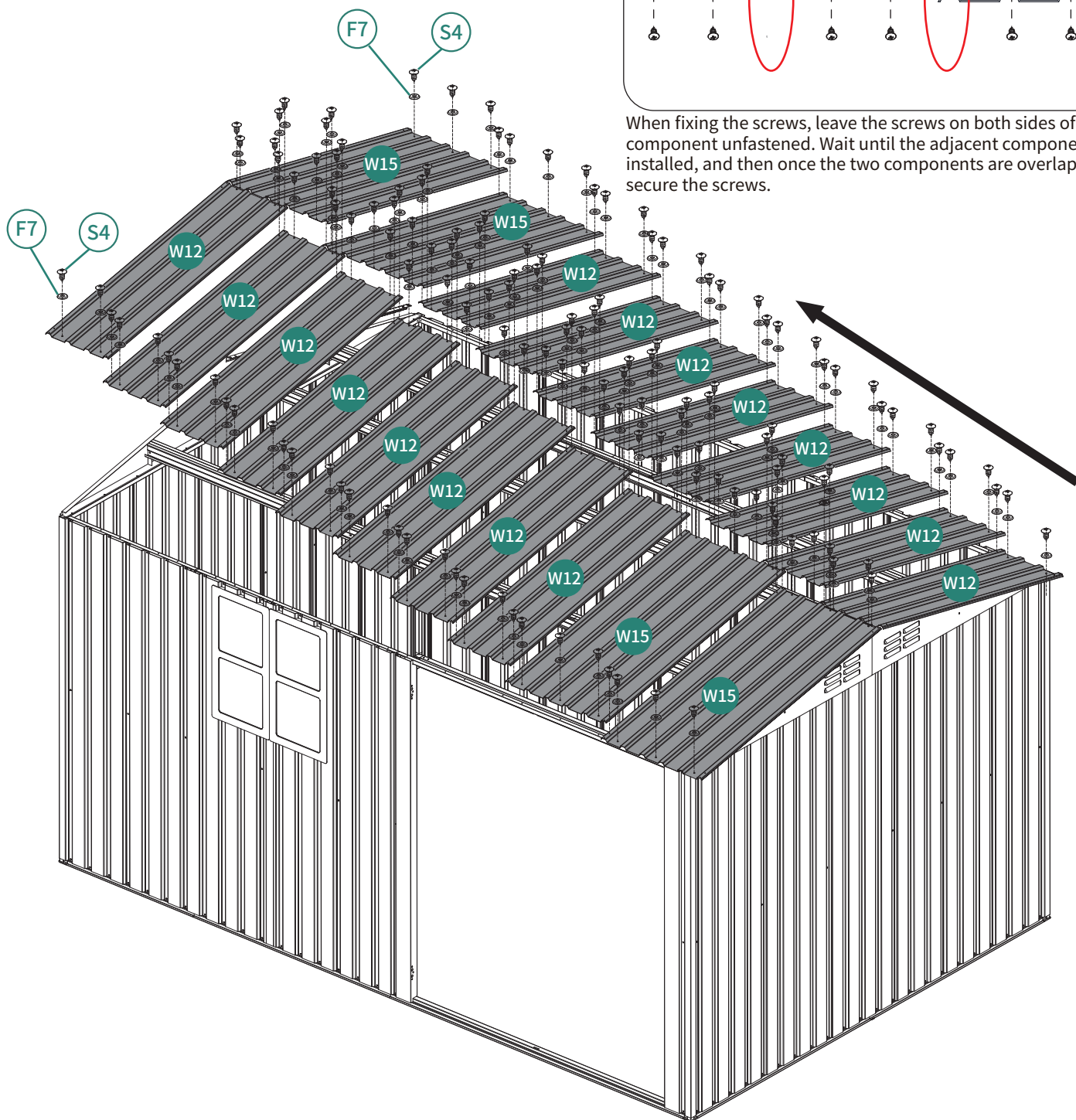

22-2

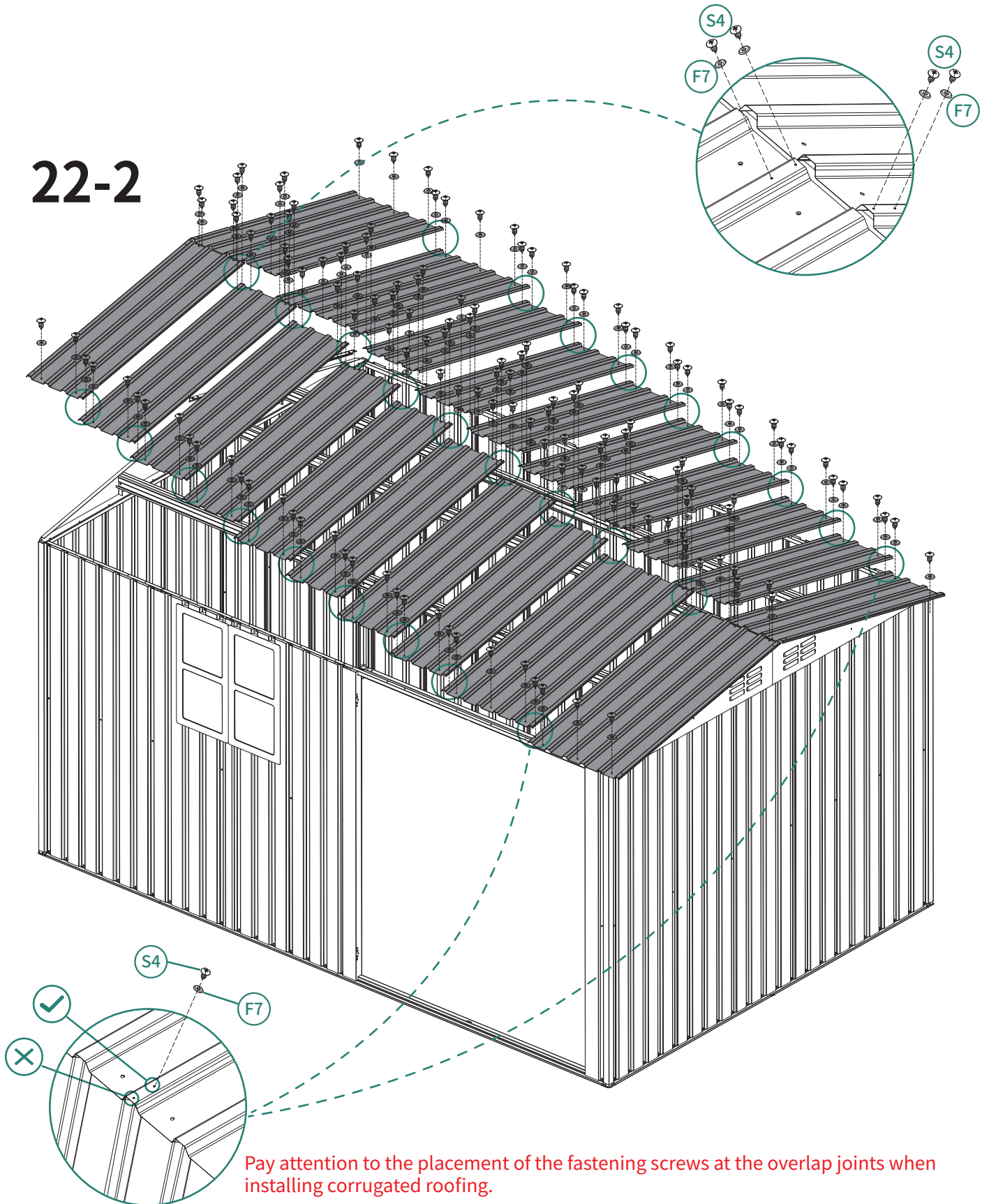

Pay attention to the placement of the fastening screws at the overlap joints when installing corrugated roofing.

23

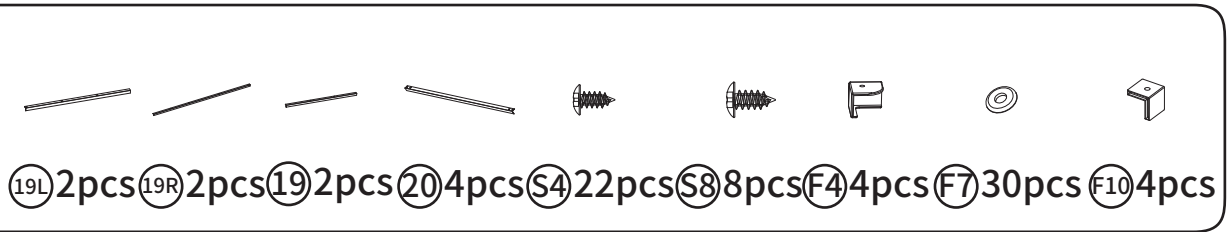

Hardware list for step 23:

- 19L 2pcs
- 19R 2pcs
- 19 2pcs
- 20 4pcs
- S4 22pcs
- S8 8pcs
- F4 4pcs
- F7 30pcs
- F10 4pcs

23-1

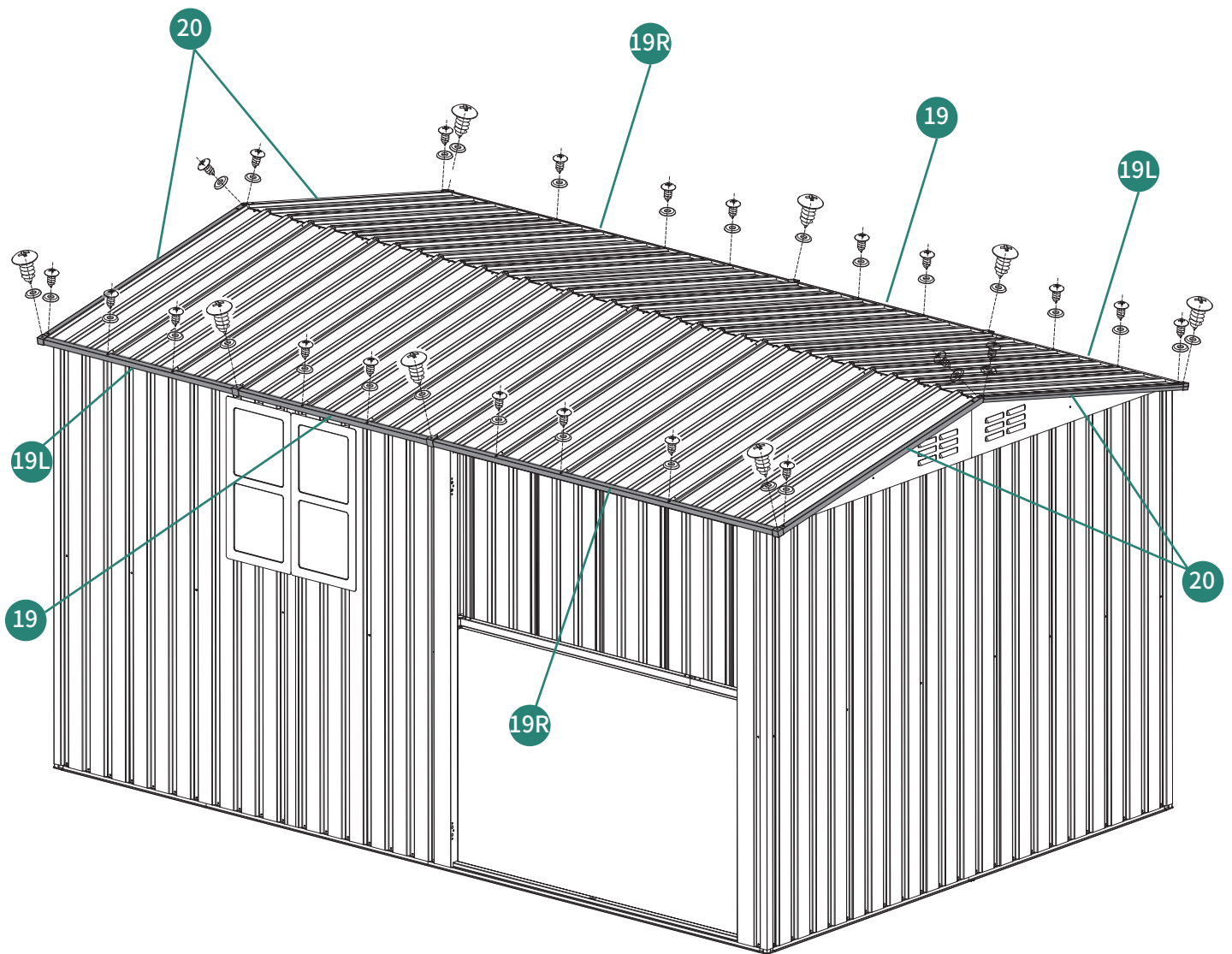

23-2

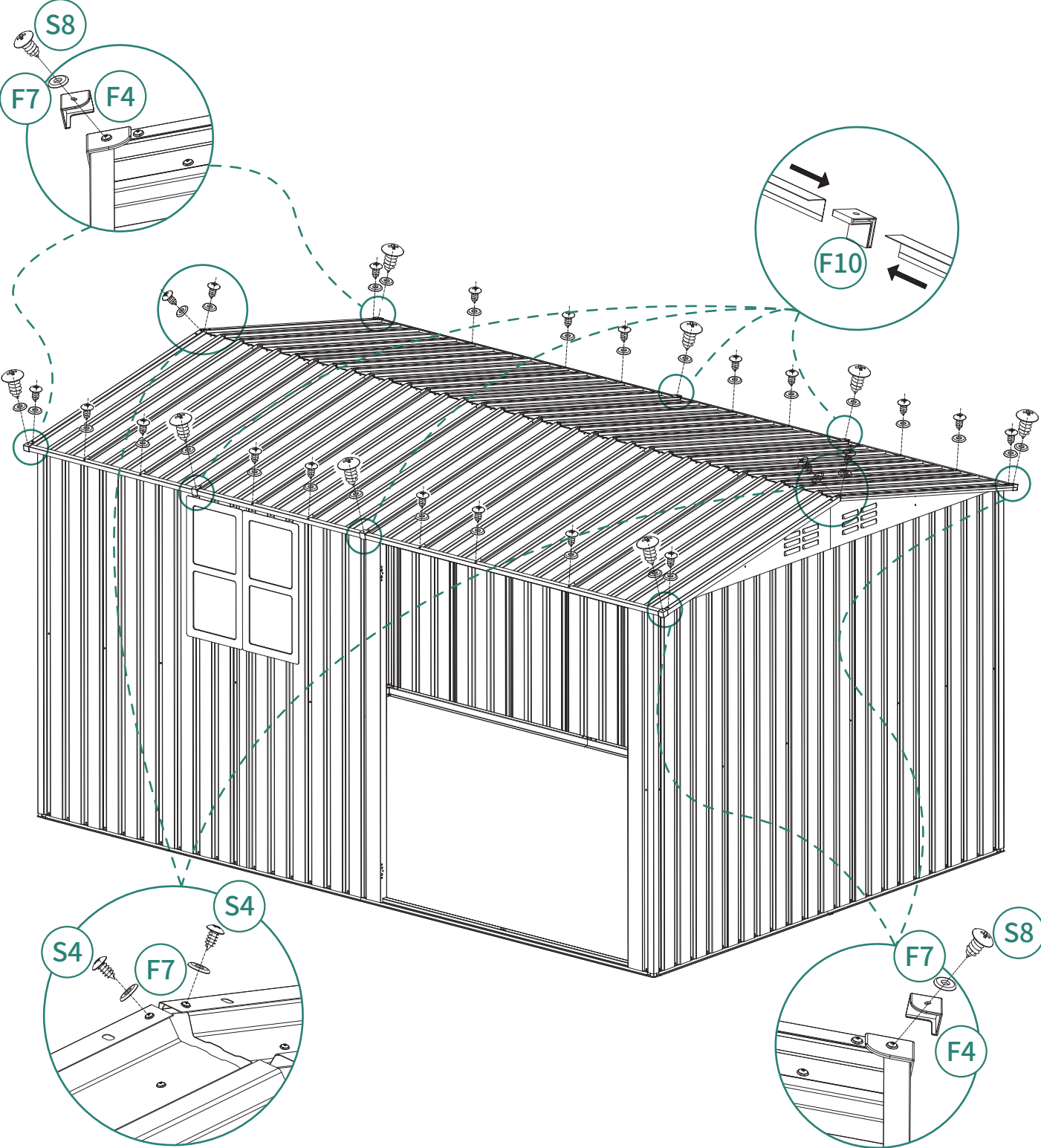

24



F8 88pcs

After fixing the screws, there will be some exposed screw parts on the component.
Please use the provided plastic protective covers to protect the exposed screw parts,
to avoid scratches during use.

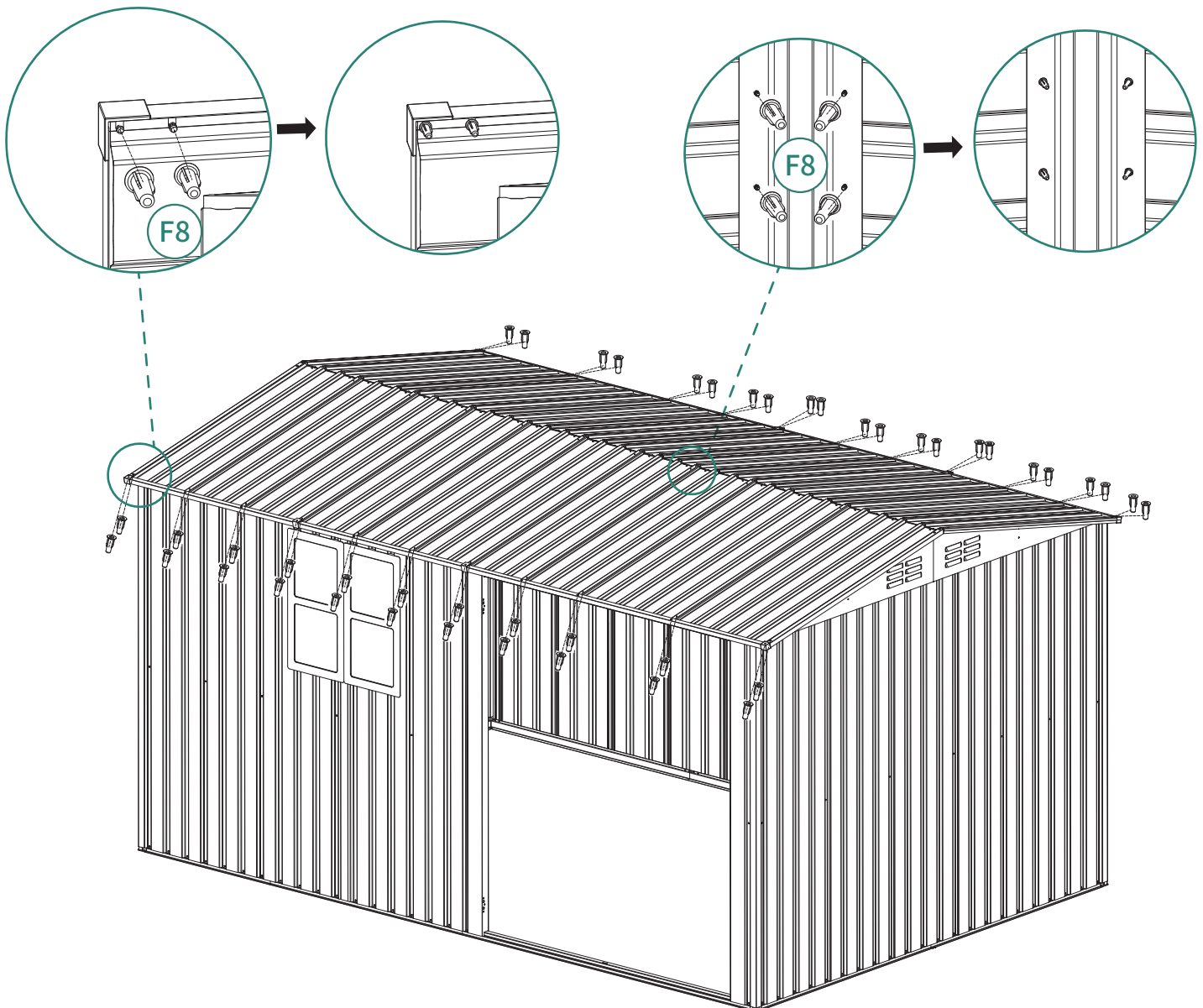

25



18 3pcs

F5 2pcs

F7 10pcs

S4 6pcs

S6 4pcs

S7 4pcs

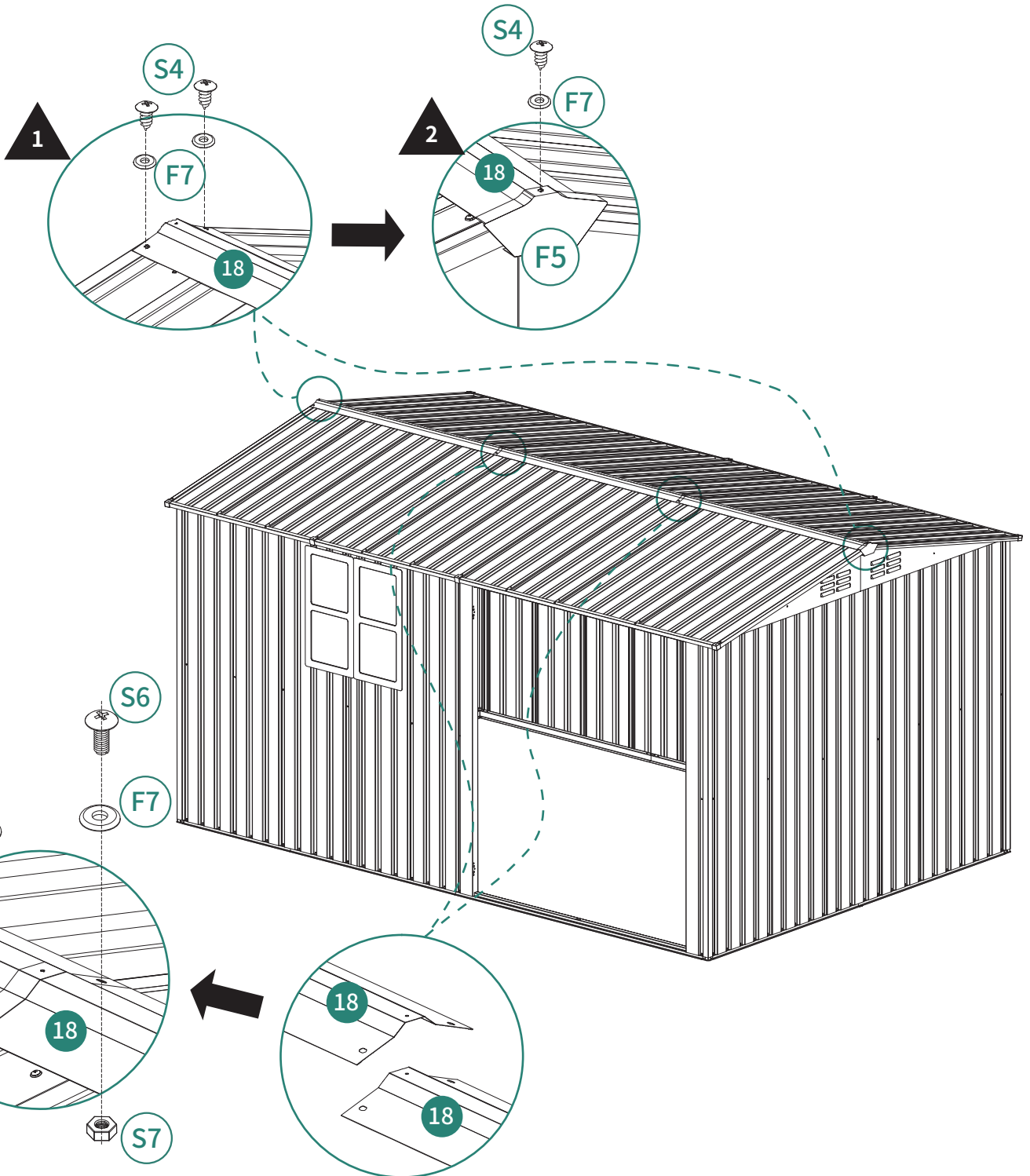

26

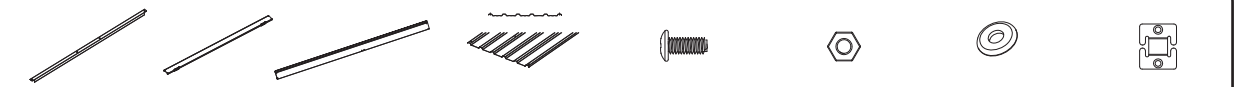
- 
- ⑮ 2pcs
 - ⑯ 1pc
 - ⑳ 1pc
 - Ⓜ 1pc
 - Ⓢ6 6pcs
 - Ⓢ7 6pcs
 - ⓕ7 4pcs
 - Ⓢ1 1pc

Install part 16 to the side of part M1 (front side panel) with the longer distance from the center screw hole to the edge, and part 22 to the side with the shorter distance.

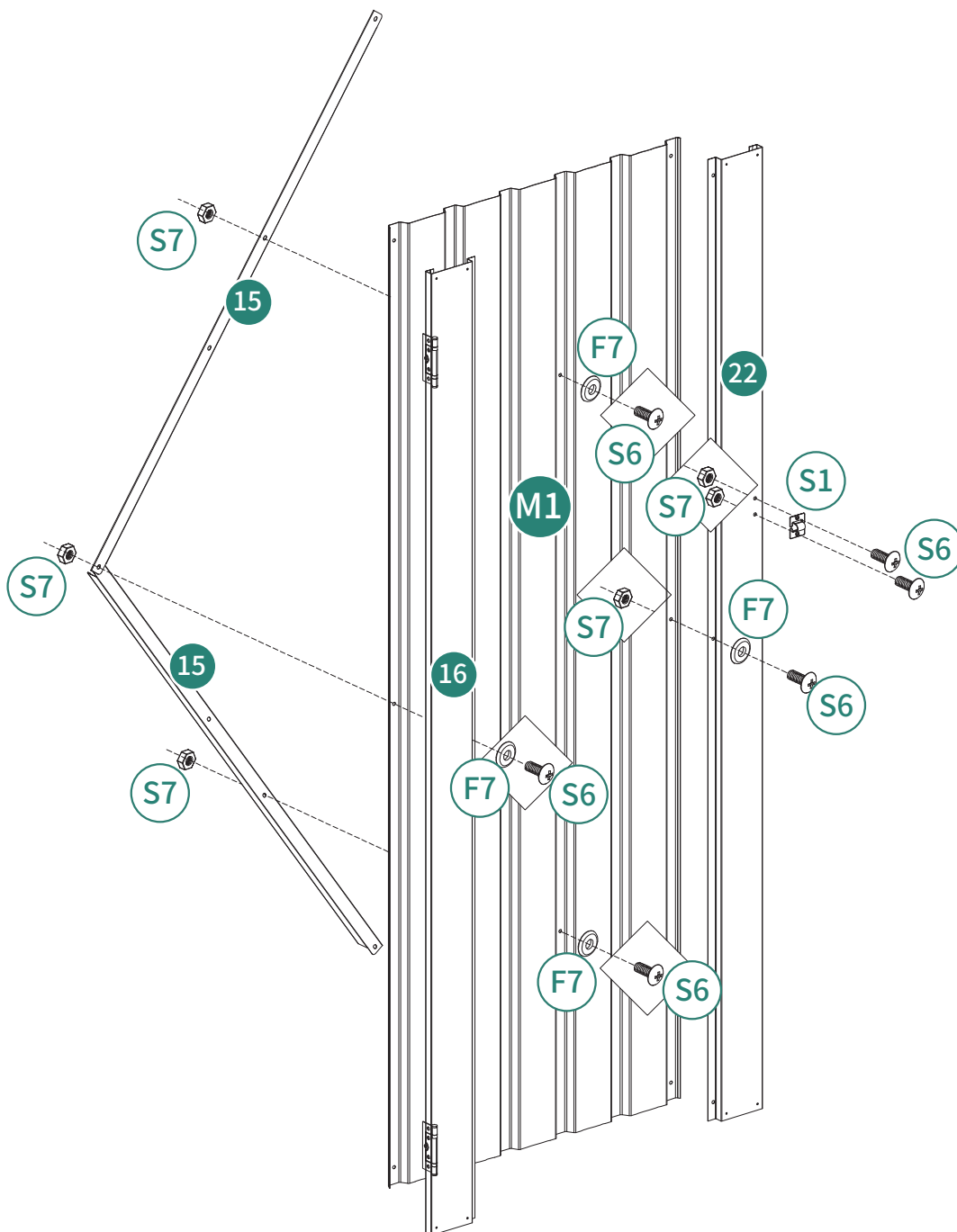

27



(21) 2pcs



(S4) 8pcs



(F7) 8pcs

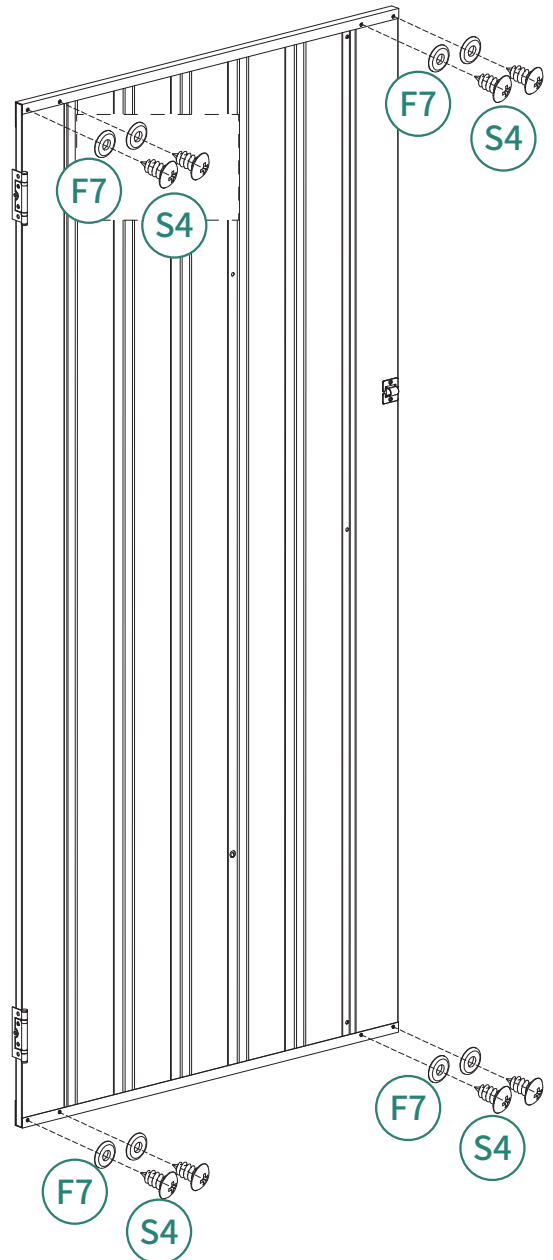
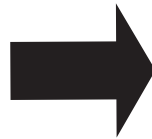
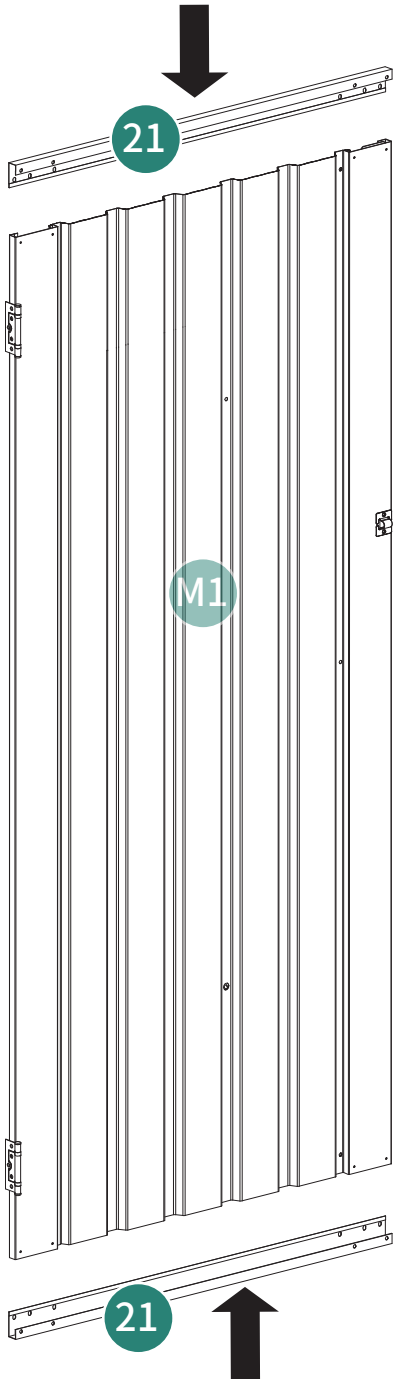

28



S4 10pcs

S6 4pcs

S7 4pcs

S18 2pcs

S19 2pcs

F7 4pcs

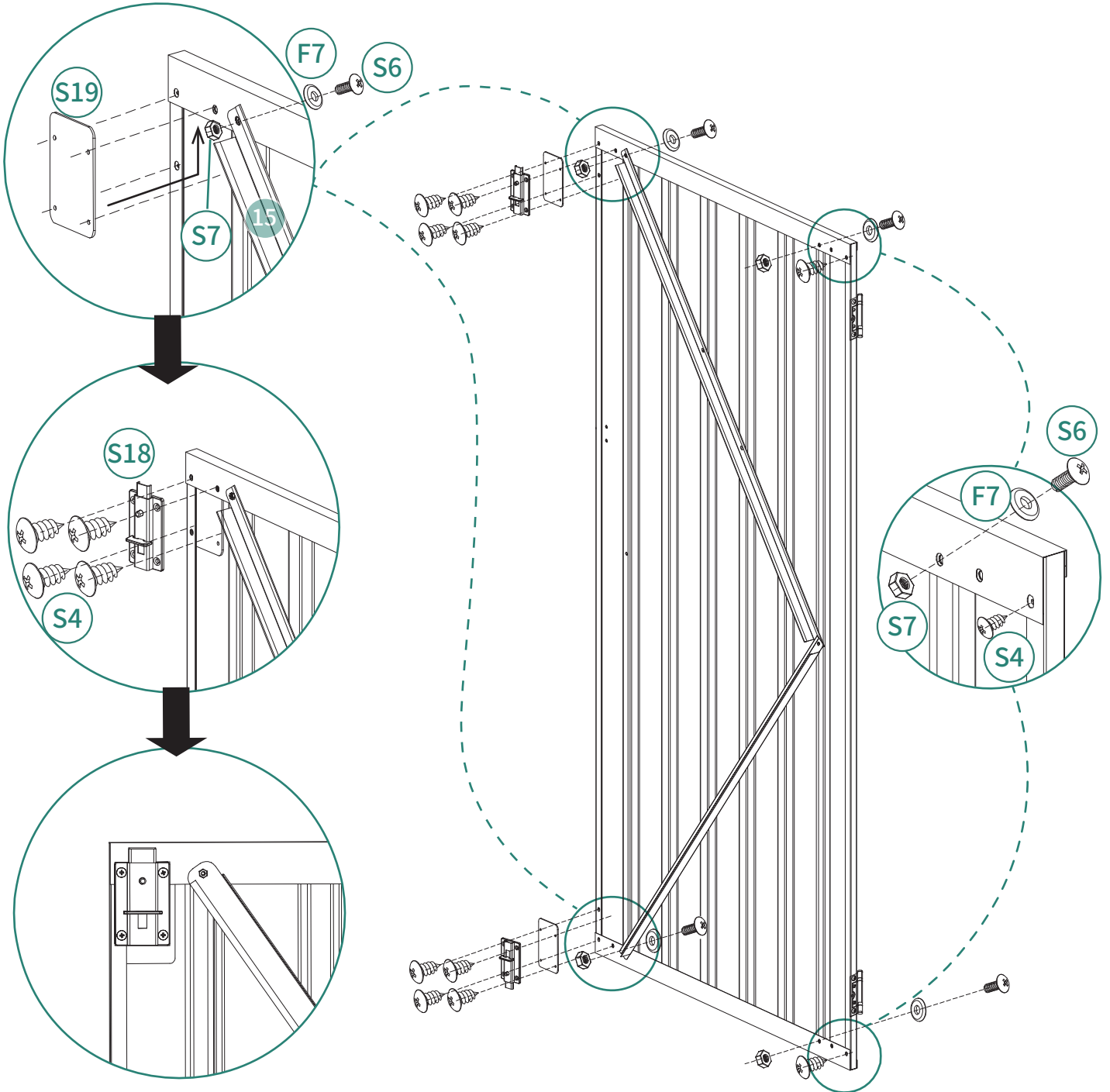

29

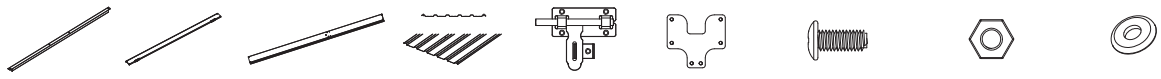
- 
- ⑮ 2pcs
 - ⑯ 1pc
 - ⑳ 1pc
 - Ⓜ1 1pc
 - Ⓢ2 1pc
 - Ⓢ3 1pc
 - Ⓢ6 10pcs
 - Ⓢ7 4pcs
 - ⓕ7 4pcs

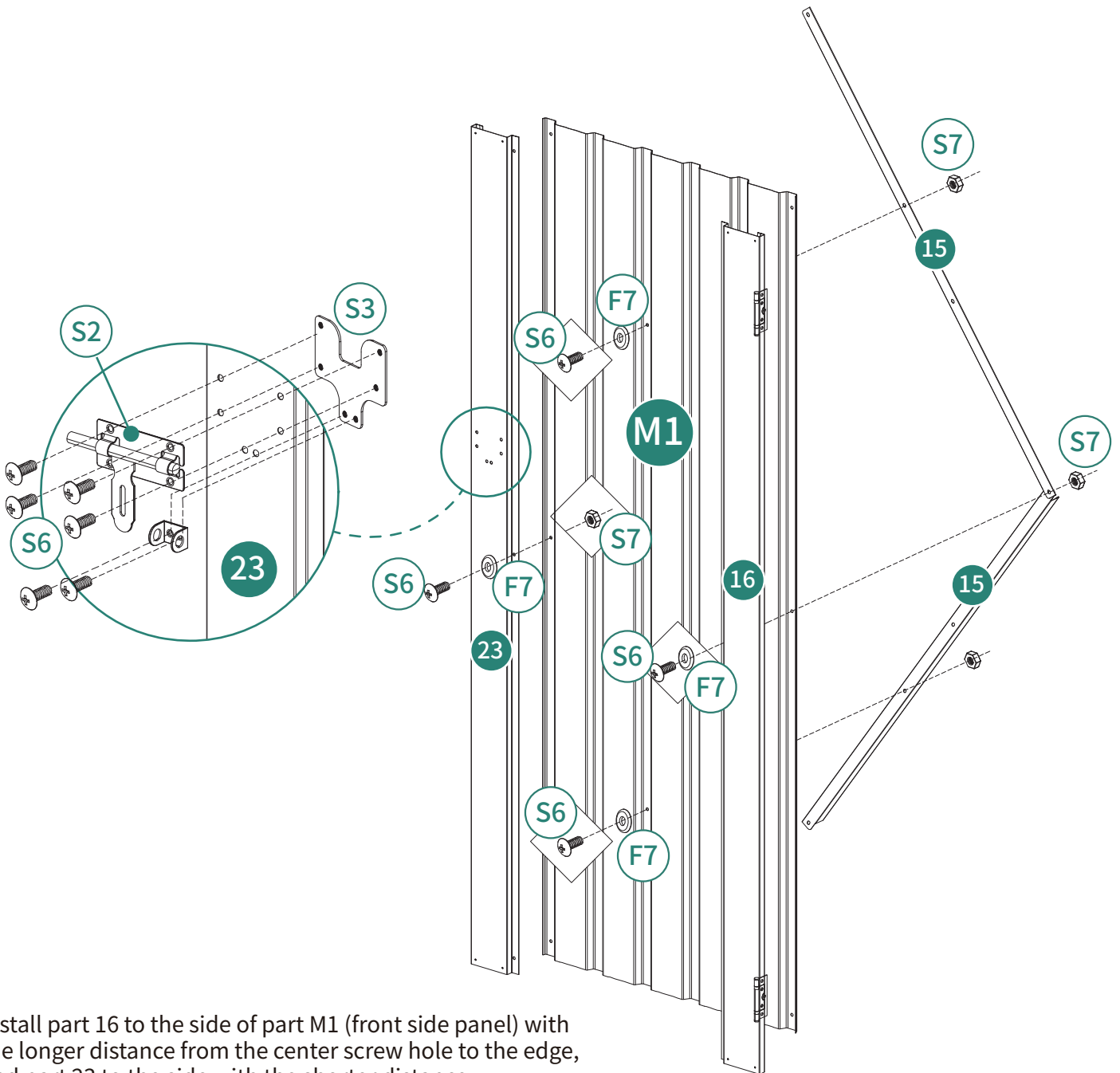

Install part 16 to the side of part M1 (front side panel) with the longer distance from the center screw hole to the edge, and part 23 to the side with the shorter distance.

30



21) 2pcs



S4) 8pcs



F7) 8pcs

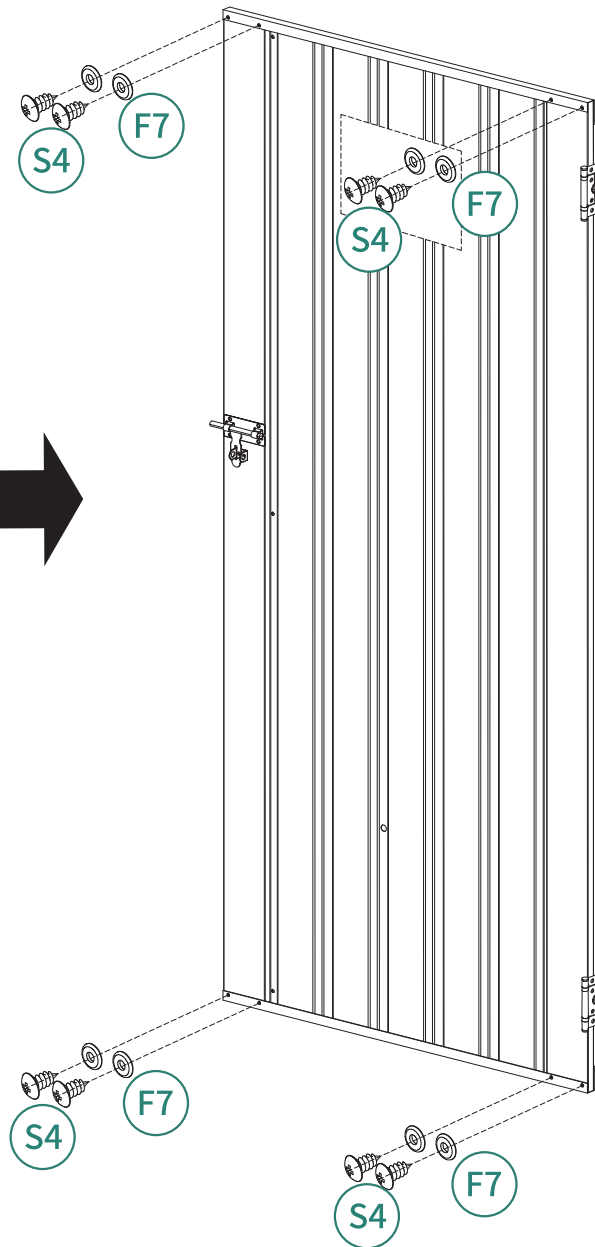
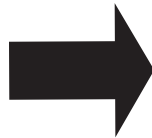
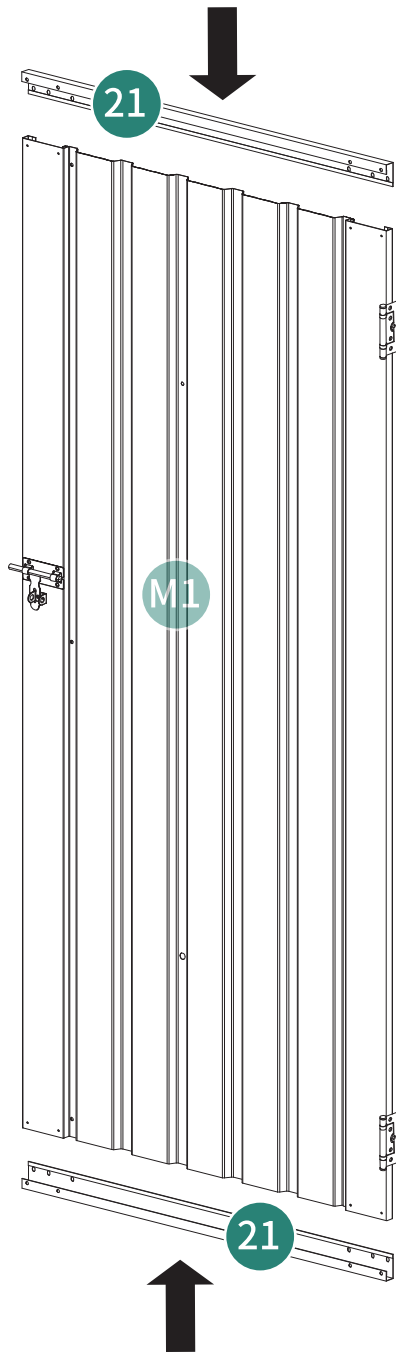

31



S4 4pcs

S6 4pcs

S7 4pcs

F7 4pcs

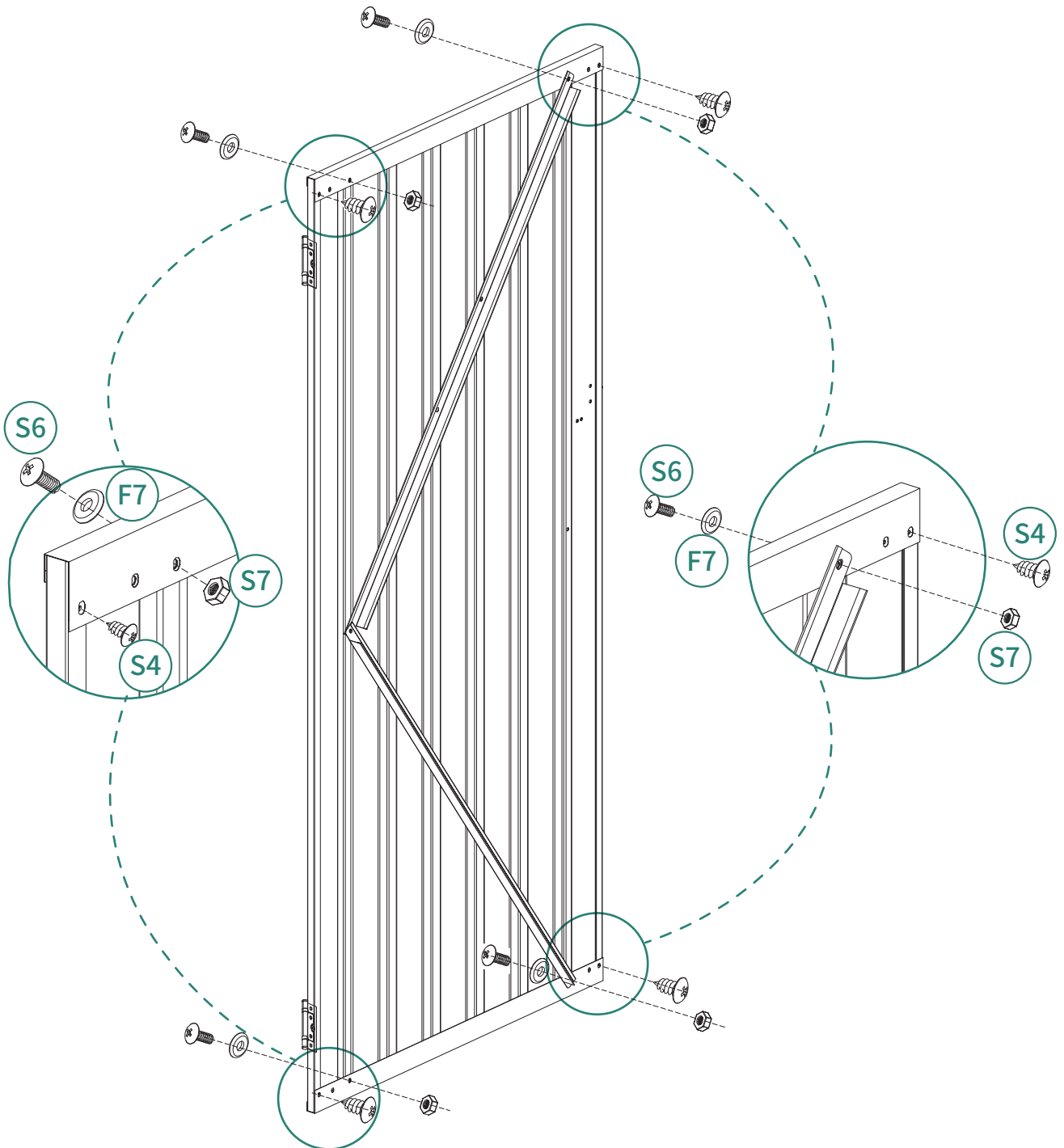

32



S6 12pcs



S7 12pcs

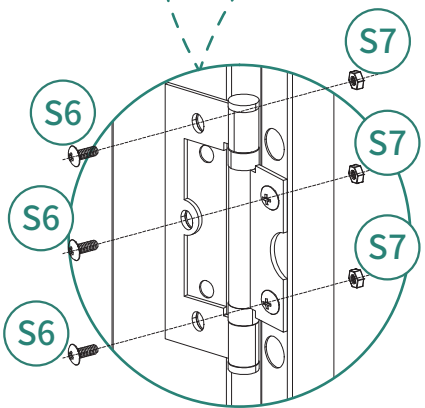
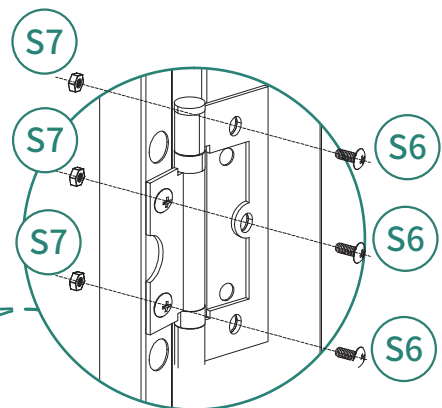
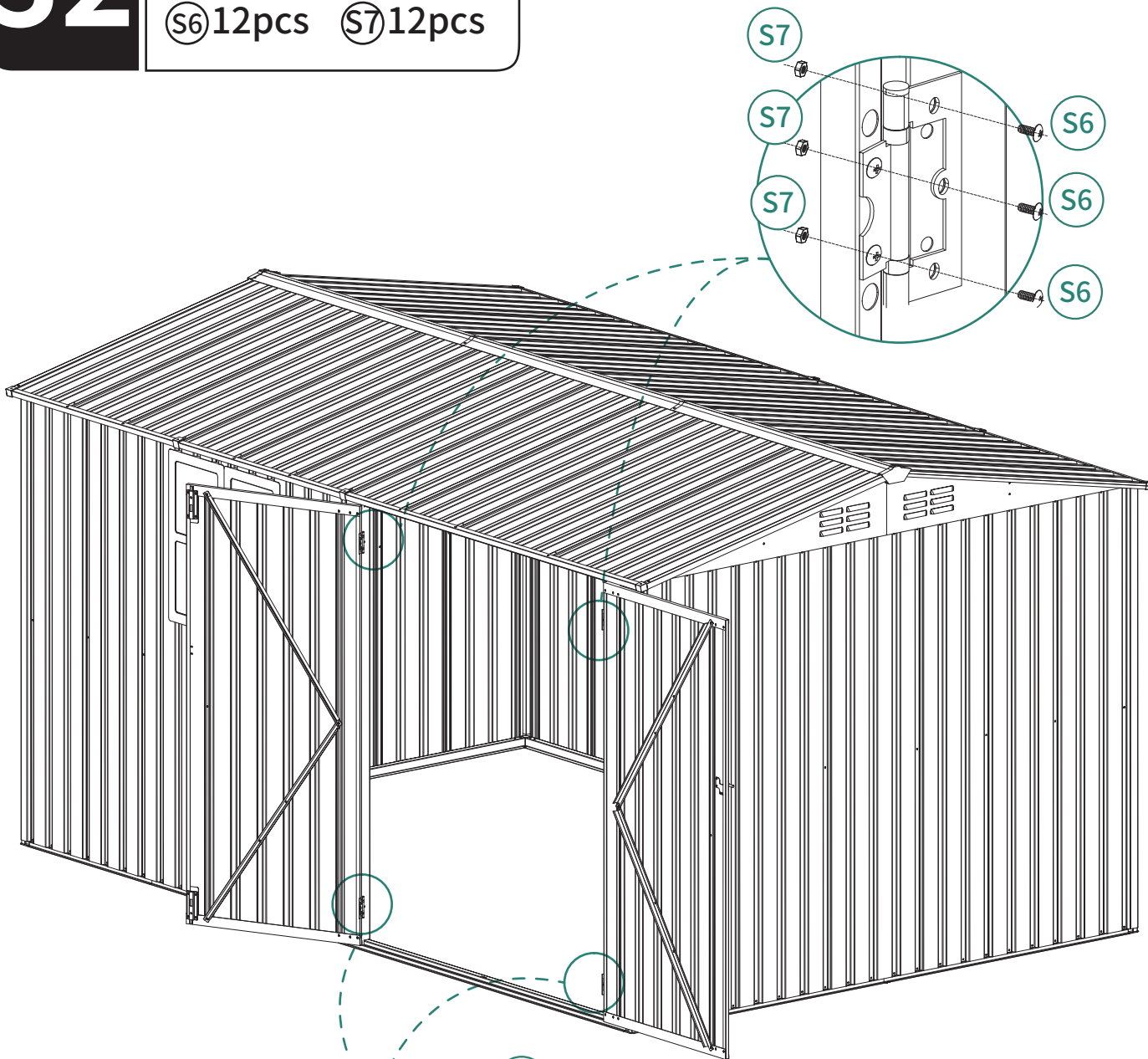

33



(S9) 4pcs

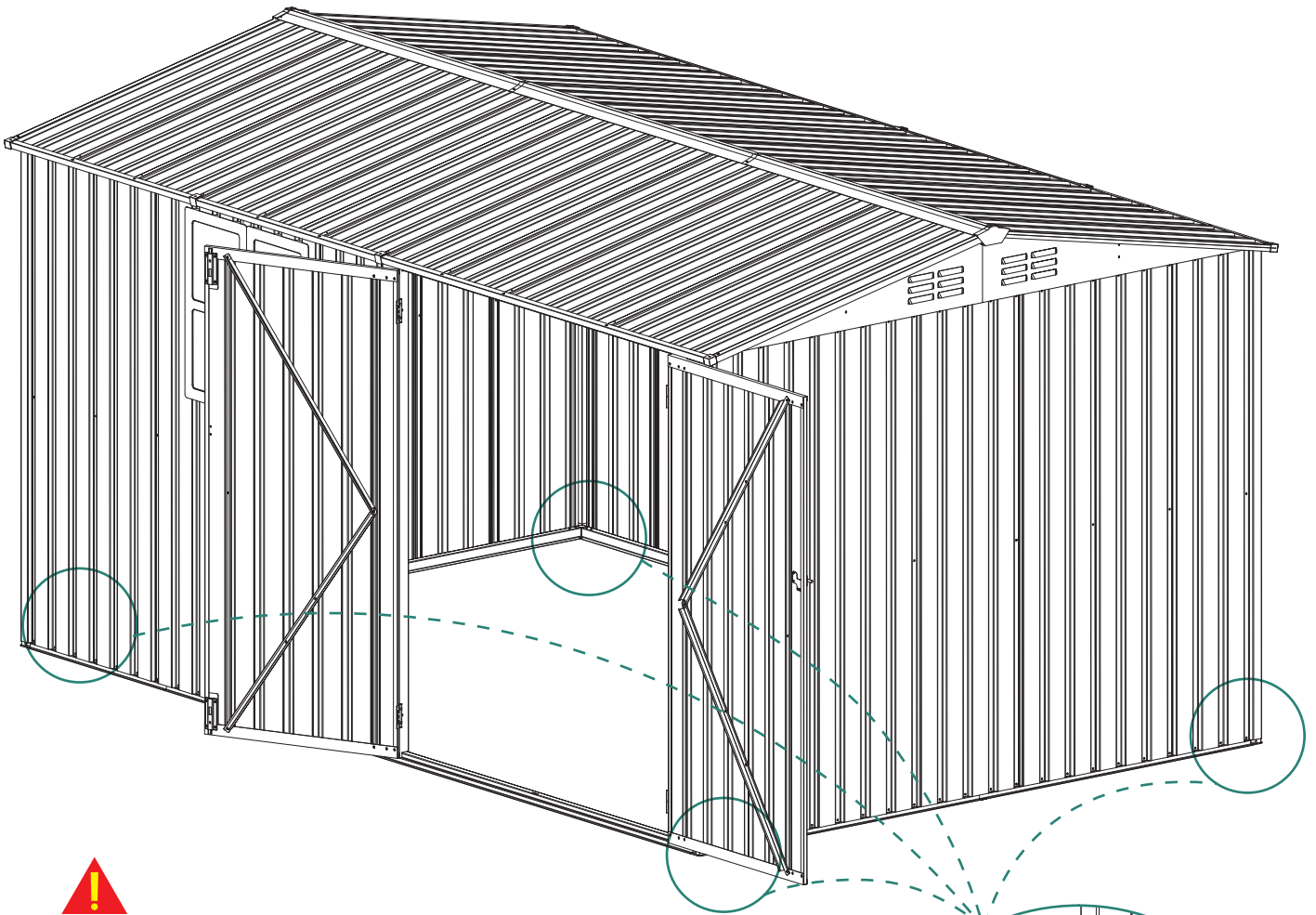

To improve the wind resistance, please be sure to complete this installation step. If expansion bolts or ground stakes are not installed, strong winds may cause the tool shed to collapse. Expansion bolts are crucial for the stability on concrete surfaces, and ground stakes are used for grassy areas. The accessory package includes the ground stake components, but the expansion bolts are not included.

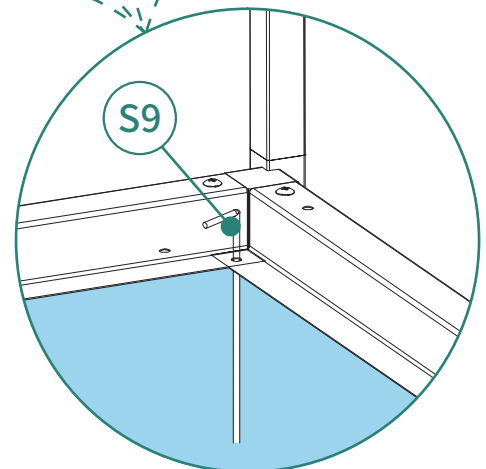

34

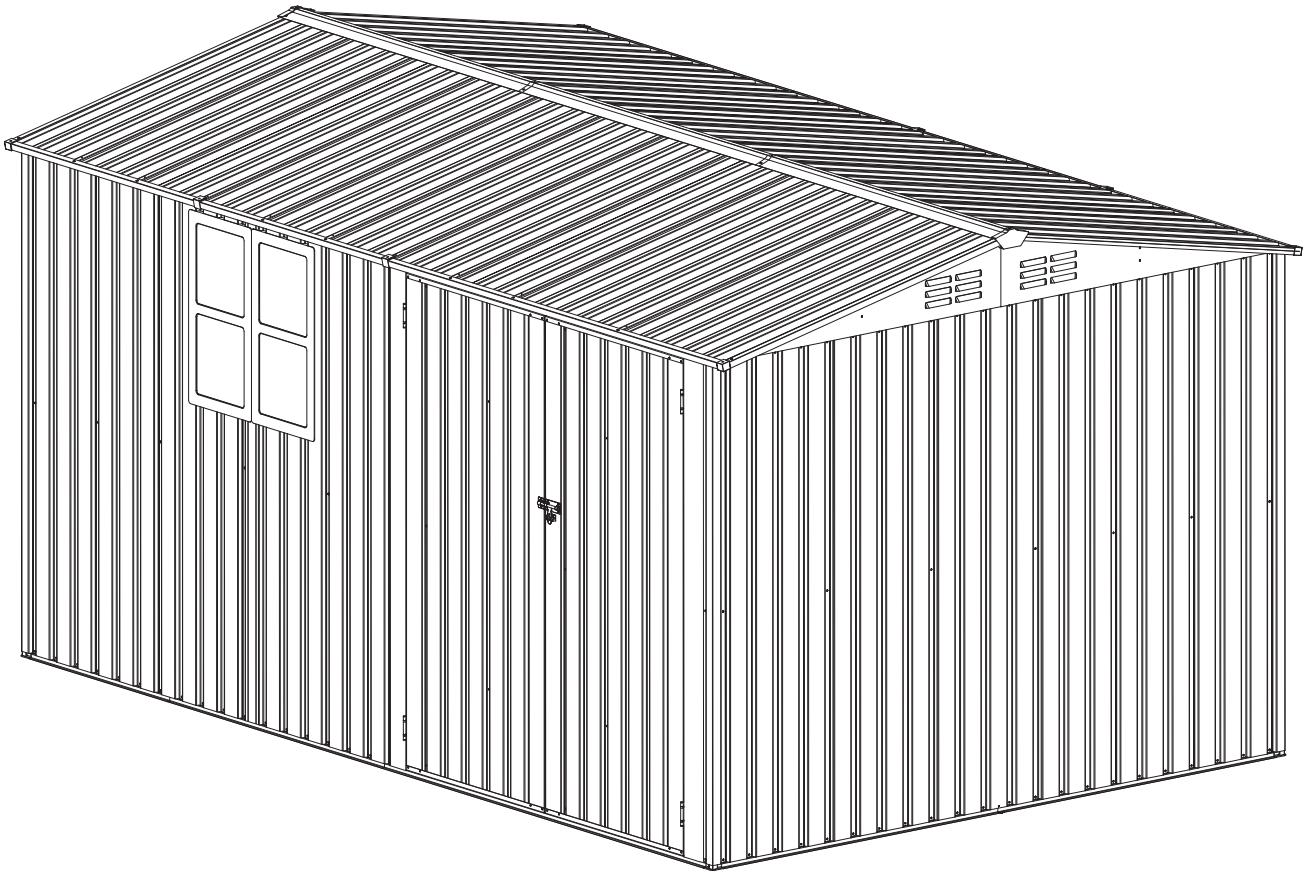

Installation Completed

Installation Abgeschlossen

Installation Complétée

Installazione Completata

Instalación Completada

HELP CENTER



Inquiry



Assembly issue



Missing parts



Returns&Refunds

If you encounter any difficulties during assembly, please contact us.

Wenn Sie während der Montage auf Schwierigkeiten stoßen, kontaktieren Sie uns bitte.

Si vous rencontrez des difficultés lors du montage, veuillez nous contacter.

Se incontri difficoltà durante il montaggio, ti preghiamo di contattarci.

Si encuentras alguna dificultad durante el ensamblaje, por favor contáctanos.

DISCLAIMER

Manufacturer and seller expressly disclaim any and all liability for personal injury, property damage or loss, whether direct, indirect, or incidental, resulting from the incorrect attachment, improper use, inadequate maintenance, unapproved modification, or neglect of this product.

Der Hersteller und Verkäufer lehnen ausdrücklich jegliche Haftung für Personenschäden, Sachschäden oder Verluste ab, egal ob direkt, indirekt oder zufällig, die durch falsche Anbringung, unsachgemäßen Gebrauch, unzureichende Wartung, nicht genehmigte Änderungen oder Vernachlässigung dieses Produkts entstehen.

El fabricante y vendedor renuncian expresamente a toda responsabilidad por lesiones personales, daños materiales o pérdidas, ya sean directos, indirectos o incidentales, derivados de la incorrecta colocación, uso inadecuado, mantenimiento insuficiente, modificación no aprobada o negligencia de este producto.

Il produttore e il venditore declinano espressamente ogni responsabilità per lesioni personali, danni materiali o perdite, dirette, indirette o incidentali, derivanti dall'errato fissaggio, uso improprio, manutenzione inadeguata, modifica non autorizzata o negligenza di questo prodotto. Le fabricant et le vendeur déclinent expressément toute responsabilité en cas de blessures corporelles, de dommages matériels ou de pertes, qu'ils soient directs, indirects ou accessoires, résultant de la fixation incorrecte, de l'utilisation inappropriée, de l'entretien insuffisant, de la modification non approuvée ou de la négligence de ce produit.