

HOROW®

Installation & User Manual

HOROW N30

Bidet Toilet

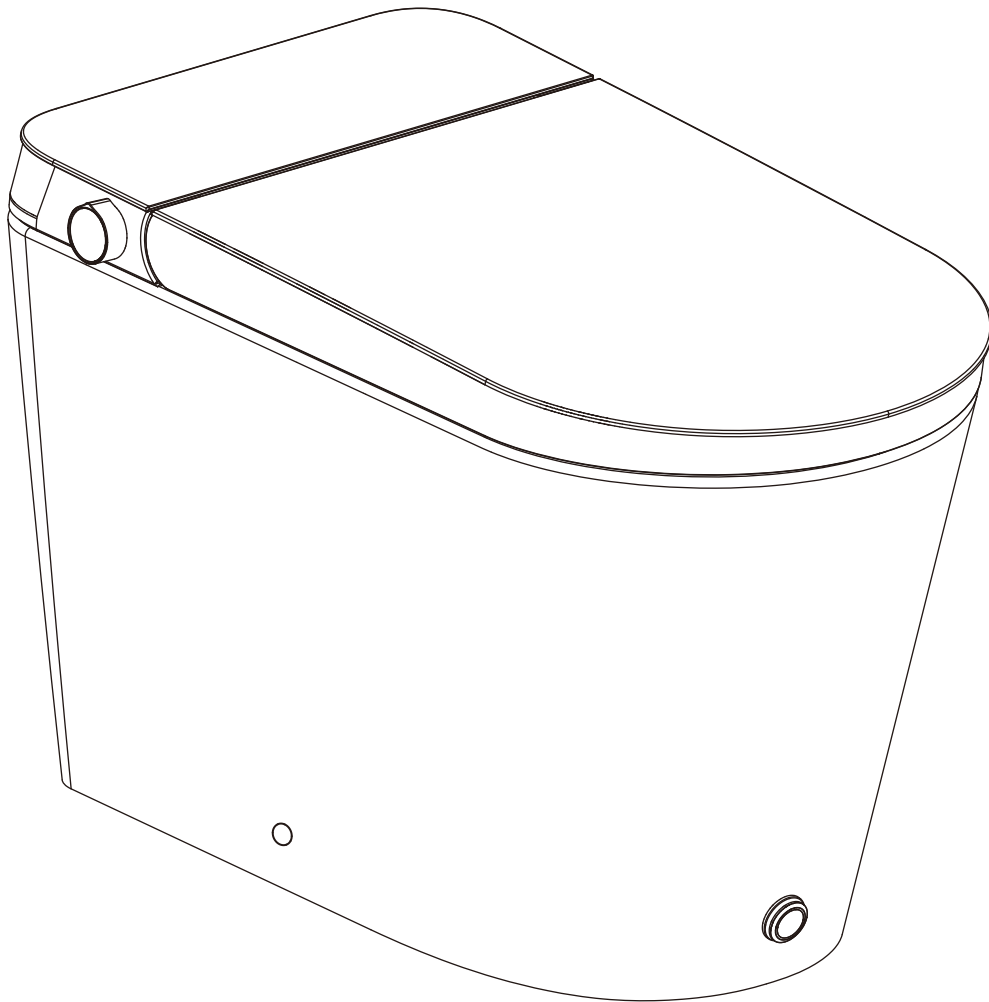

Contents

Important Safeguards	1
Important Information	1
Explanation of Terms and Symbols	2
Overall Sketch	5
Function Table	6
Product Installation	7
Tools Needed for Installation	7
Parts Included	7
Prior to Installation	8
Installation of Bidet Toilet	10
Installation of Battery	13
Product Test Run	14
Usage Instructions	15
Function Explanations	15
Kick Control Operations	15
Knob Operations	16
Daily Maintenance	16
Maintenance of Ceramics, Seat and Lid	17
Maintenance of the Nozzle	17
Maintenance During Winter Season	17
Troubleshooting	18
Specifications	19
Warranty	20

- Thank You for Choosing HOROW. Please read the instructions carefully before installation and keep it available for future maintenance or reference.
- We are not responsible for the accidents resulting from the user's negligence.
- HOROW reserves the right to make revisions to this manual without notice.



Need help? Contact HOROW Customer Service Team.

Phone: (+1)209-200-8033

Monday to Friday

Email: support@horow.com

Important Safeguards

Read All Instructions Before Using

Important Information

When using the product, especially when children are present, basic safety precautions should always be followed, including the following:



DANGER - To reduce injury to persons:

1. Do not use while bathing.
2. Do not place or store product where it can fall or be pulled into a tub or sink.
3. Do not place in or drop into water or other liquid.
4. Do not reach for a product that has fallen into water.
5. Do not wash the main unit with water or detergent.
6. During installation, disassembly, repair and maintenance of the product, the water supply must be shut off.













WARNING - To reduce the fire or injury to persons:

1. Close supervision is necessary when this product is used by, on, or near children or invalids.
2. Use this product only for its intended use as described in this manual. Do not use attachments not recommended by HOROW.
3. Never operate this product, if it is not working properly, or if it has been dropped, damaged, or immersed in water. If any of these conditions apply, contact our Customer Service Team directly.
4. Never use while sleeping or drowsy.
5. Never drop or insert any object into any opening or hose.
6. Do not use outdoors or in environments where aerosol (spray) products are being used or oxygen is being administered.
7. Caution - Do not remove the toilet lid (or back) on your own. Refer servicing to qualified service personnel.

Explanation of Terms and Symbols

To ensure proper and safe use of this product, please read this section carefully before use. After reading, store this manual in a safe place for any needed future reference.

The hazards and warnings listed herein are important to our user's safety. Significant consequences may result from failure to heed warnings. The company will not be held liable for any injuries or damages caused by improper use or failure to follow the safety instructions.

	Indicate possible injury resulting from improper usage due to negligence of this sign.
	Indicate human injury or property loss that may result from improper usage due to negligence of this sign.
	Indicate a strict request to follow noted precautions when used with the above "Warning" and "Attention" signs.
	Prohibit any individual from performing any action with this symbol.
	Prohibit any individual from dismantling product.
	Keep product away from any wet environments, including, but is not limited to, humid environments, close proximities to baths, showers or sinks.
	Do not touch!
	Operate only as instructed!
	Do not touch with a wet hand!
	Keep away from any extreme heat or fire!

Warning

Do not touch, insert or pull out the battery with a wet hand.

※ Risk of battery leakage.



Do not place a lit cigarette along with other burning objects into the unit.

※ Risk of fire.



For cleaning or maintenance of plastic parts, do not use any harsh cleaning agents. (These include, but are not limited to products such as concentrated sulfuric acid, concentrated nitric acid, glacial acetic acid, carbon tetrachloride, chloroform, benzene, phenol, methylphenol, dimethylformamide, methyl ether, soybean oil, acetate, 40% nitric acid, thick salt acid, 95% alcohol, gasoline, kerosene, etc.)

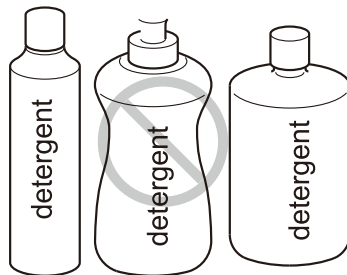

- ※ Risk of damaging parts that can lead to accidents and injuries.

Do not use polluted water or water meant for industrial use.



- ※ Risk of cystitis and dermatitis.
- ※ Untreated water may also cause internal corrosion of the product.

Do not apply any force to the unit's seat and lid. Do not stand on the lid or open or close the lid and the seat forcefully.

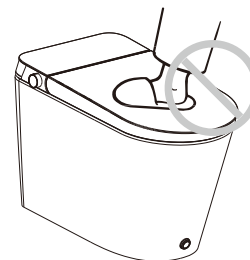

- ※ Risk of product damage and/or user injury.

Do not add water or detergent into the unit. Do not soak the product with water or cleaner.



- ※ Risk of product damage.

Any person with a disability, the elderly, and children should be using this product with the supervision of another individual.



Do not install the product in a humid environment or a soaked room. Do not spray or soak this product with any form of liquid to prevent any damage to the product.



- ※ Risk of accident that may lead to user injury.

This product is not a toy. Advise children not to play with product.



- ※ Risk of injury.

Do not dismantle, repair or alter this product on your own. Call in a professional for further advice.



- ※ Risk of accident that may lead to injury.

 **Battery Warning**

Read the following for proper battery usage.

- ① Properly install the battery according to its correct polarity.
- ② Remove the battery during long periods without use.
- ③ Replace the battery in time.
 - ※ Failure to do so may result in interrupted control signals.
- ④ Cover the battery with tape before disposal. This will prevent battery fluid leaks that may cause fire and/or other damages.
- ⑤ Place the battery out of children and infant reach.
 - ※ If battery is swallowed, contact a doctor immediately.
- ⑥ If battery fluid leaks onto user, quickly rinse off using clean water.
- ⑦ If battery fluid gets into eyes, do not rub your eyes. Quickly rinse it with clean water and consult a doctor immediately.
 - ※ Failure to do so may result in vision impairment or blindness.

**When the battery is in use, do not do the following operations:**

- ① Do not hold or store with metal objects (such as a necklace or a watch).
- ② Do not mix new and old batteries.
- ③ Do not pull apart battery or throw it into water and/or fire. Battery fluids may cause a fire.

 **Attention**

When storing or transporting in cold climate, make sure to remove all water from the unit. Product may crack and other damages may occur due to freezing water.

- ※ Risk of leakage and product damage.



Avoid direct sunlight or heat.

- ※ Risk of product discoloration.



Remove the battery when the product is in disuse for an extended amount of time. Make sure to shut off the water and remove the water inside the product.

- ※ Risk leakage and product damage.



Do not spray urine in the direction of the bidet nozzle.

- ※ Doing so may result in blockage to the bidet nozzles and cleaning area.



Overall Sketch

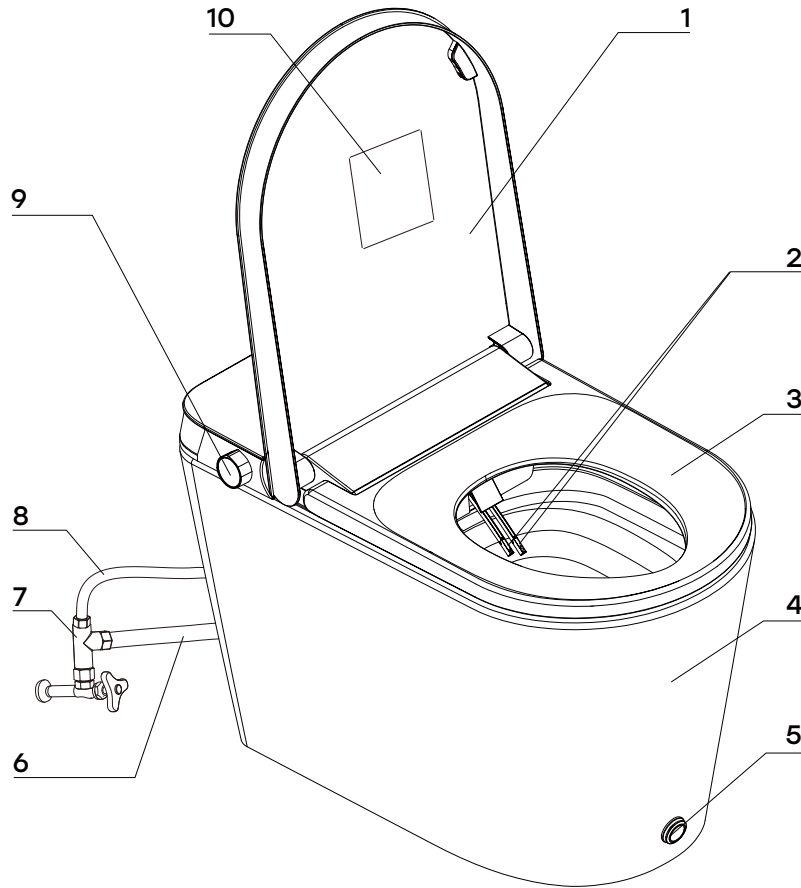

1	Lid
2	Detachable Nozzle
3	Seat
4	Ceramic Toilet Bowl
5	Kick Control
6	Flush Water Hose
7	T-valve
8	Clean Water Hose
9	Knob
10	Caution

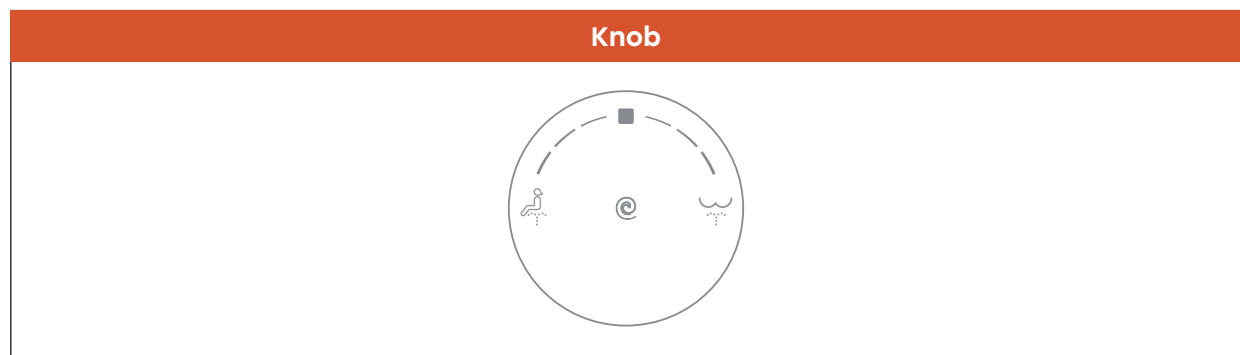

Function Table

Category	Model	N30
Hygiene	Feminine Wash	●
	Posterior Wash	●
	Detachable Nozzle	●
	Pre-wet	●
	Hygienic Seat	●
	Easy-clean Glaze	●
Comfort	Adjustable Water Pressure	●
Convenience	Auto Flush	●
	Kick Flush	●
	Soft Close	●
Safety	SUS Filter	●
	Air Isolation & Backflow Prevention	●

Note:

No electricity is required for this bidet toilet, and it only provides cold water wash.

Product Installation





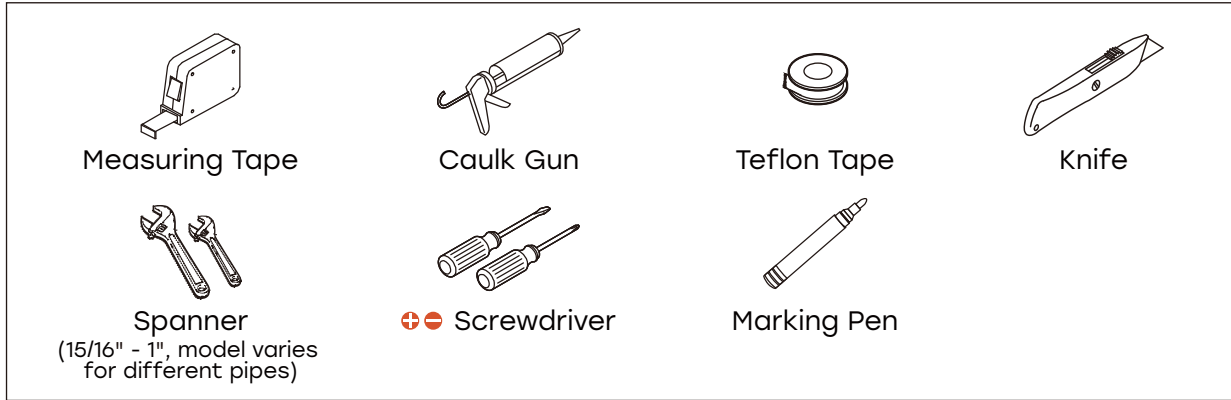





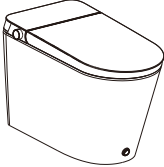

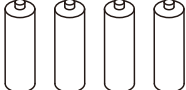
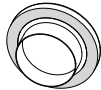
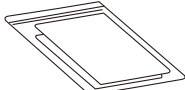



















Tools Needed for Installation

Please have these tools prepared prior to installation.



Parts Included

Please confirm that all items below are inside the box.

<p>Bidet Toilet (1 pc)</p> 	<p>T-valve (1 pc)</p>	<p>Water Flow Detection Bag (1 pc)</p> 									
<p>AA Batteries (4 pcs)</p> 	<p>Wax Ring (1 pc)</p> 	<p>Installation & User Manual</p> 									
<p>Installation Template (1 pc)</p> 	<p>Floor Flange (1 pc)</p> 	<p>Bumper Pad (1 pc)</p>  <p>(Spare part, used for the seat)</p>									
<p>Mounting Accessory Kit:</p> <table border="0"> <tr> <td> Expansion Bolt (4 pcs)</td> <td> Mounting Block (2 pcs)</td> <td> Fixing Sleeve (2 pcs)</td> </tr> <tr> <td> Screw (4 pcs)</td> <td> Toilet Screw (2 pcs)</td> <td> Bolt (2 pcs)</td> </tr> <tr> <td> Washer (6 pcs)</td> <td> Nut (2 pcs)</td> <td> Decorative Cap (2 pcs)</td> </tr> </table>			 Expansion Bolt (4 pcs)	 Mounting Block (2 pcs)	 Fixing Sleeve (2 pcs)	 Screw (4 pcs)	 Toilet Screw (2 pcs)	 Bolt (2 pcs)	 Washer (6 pcs)	 Nut (2 pcs)	 Decorative Cap (2 pcs)
 Expansion Bolt (4 pcs)	 Mounting Block (2 pcs)	 Fixing Sleeve (2 pcs)									
 Screw (4 pcs)	 Toilet Screw (2 pcs)	 Bolt (2 pcs)									
 Washer (6 pcs)	 Nut (2 pcs)	 Decorative Cap (2 pcs)									

Prior to Installation

Please confirm that all the aforementioned items in the package are present. In case of any missing parts, please feel free to contact our Customer Service Team. Illustrations above are for reference only. The ceramic product may have slight deformation during the firing process. Please consult the actual product for accurate details.

Verify the product dimensions and secure enough installation space. The rough-in size refers to the distance between the center of the toilet flange to the finished back wall.

※ All dimensions are manually measured with a certain degree of error. For the specific size, please refer to the actual product received.

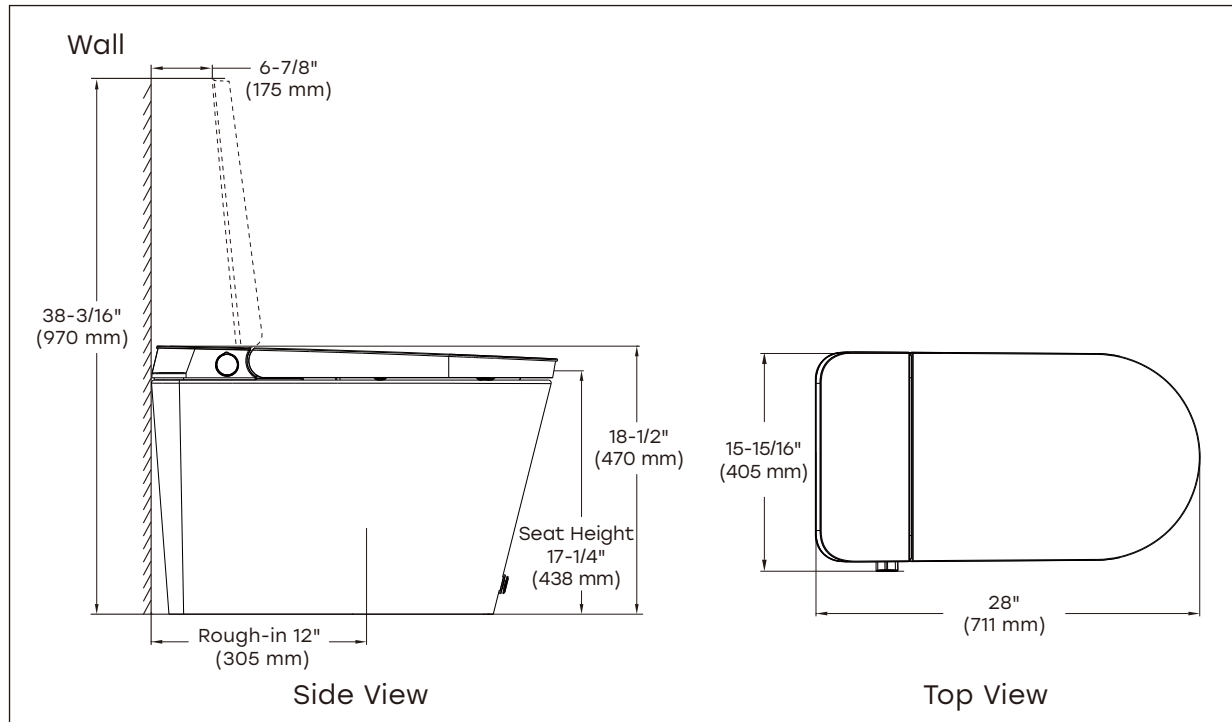

To ensure proper installation, the distance between the water supply valve and the centerline of the toilet should be greater than half the width of the toilet bottom. The water supply valve should be about 8" (203 mm) away from the toilet centerline. For larger valves, a greater distance may be necessary to ensure proper clearance. For easy installation and maintenance, a range of 9" (229 mm) to 11" (279 mm) is recommended.

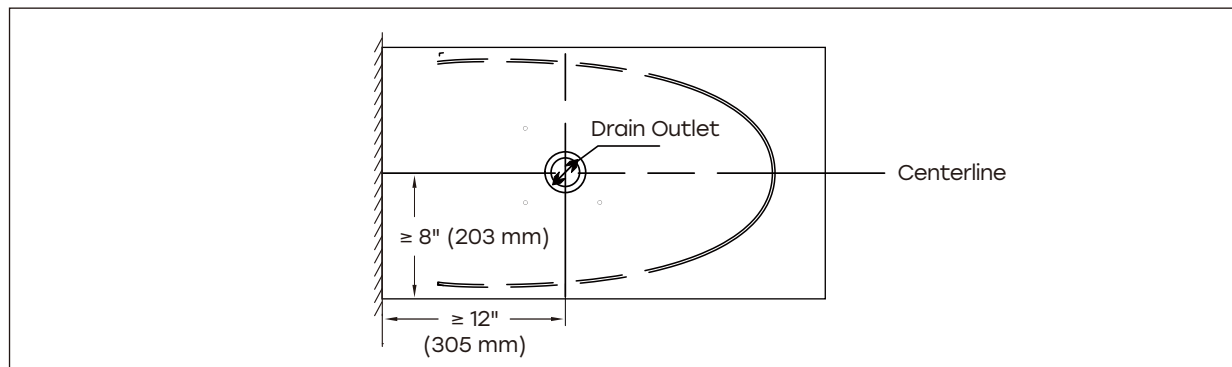

The product is a tankless toilet. The minimum water pressure required is 35 psi, and the maximum water pressure is 108 psi. If the minimum water pressure is not met, the bidet toilet may not achieve the optimal cleaning performance. A water flow detection bag is provided for the user to test whether the water pressure is qualified.

Install a suitable hose onto your water outlet and direct it to the water flow detection bag provided.

- ※ If you cannot find a compatible hose, you can cover the water outlet with a cloth and place a bucket (3 gallons or more) under the valve.

Turn on the water valve and ensure that at least 1.32 gallons of water flow out within 15 seconds.

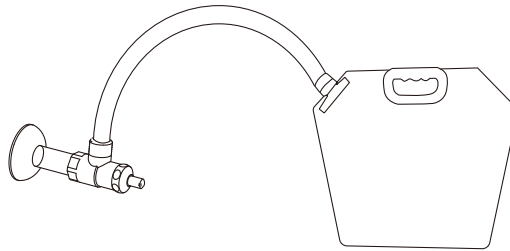

- ※ If this condition is not met, the flushing efficiency may be compromised. In this case, you may need to use an additional booster pump to increase the water pressure.

Turn off the water valve and remove the hose installed.

Installation of Bidet Toilet

Install your toilet using the following steps:

Please remove the old toilet first if any and ensure the mounting surface is clean and level before the new toilet is installed.

1 Open the box right side up

Remove the accessories first, then lift the toilet with two people, remove the packaging, and gently place the toilet on the floor, as shown in the diagrams below.

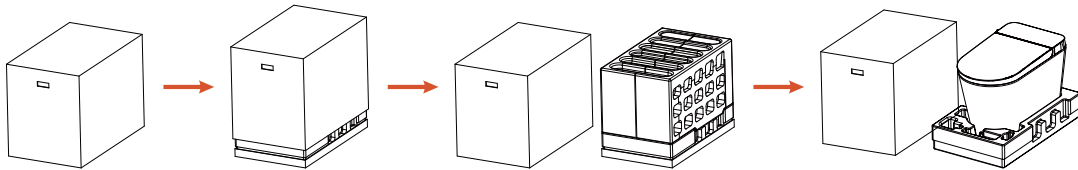

2 Install with installation template

Align the installation template with the centerline of drain outlet.

Mark four mounting holes based on the installation template with the marking pen. Then, outline the edges of the template to mark the toilet placement for later installation.

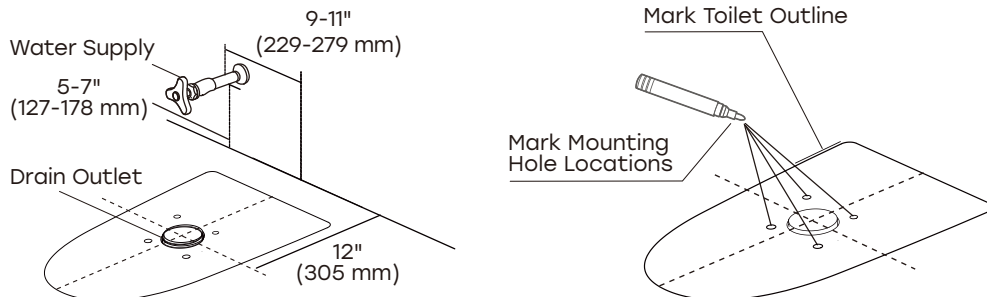

3 Install and fix the flange

Drill four 3/8" (10 mm) holes at the marked locations from the previous step. Insert four expansion bolts into the holes. Position the flange on the drain pipe outlet, aligning the four flange holes with the drilled holes on the ground. Then, insert the washers and screws into the flange holes and tighten them using a screwdriver.

※ If an applicable flange is already in place, there is no need to install the new one.

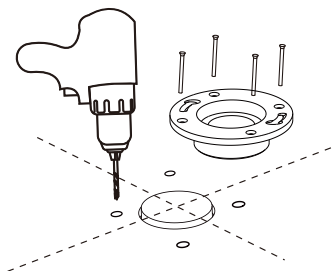

4 Install the mounting blocks

Assemble the mounting blocks with bolts, position the two mounting blocks on opposite sides of the flange on the ground and secure them with washers and nuts.

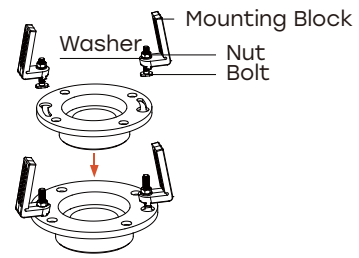
**5 Install the ceramic toilet**

Install the wax ring onto the drain hole at the bottom of the ceramic toilet and press it firmly into place.

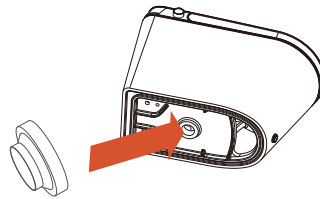

Lift the ceramic toilet with two people and gently lower it onto the flange, letting it well fit the mounting blocks.

Press down firmly on the ceramic toilet to ensure the wax ring forms a complete seal.

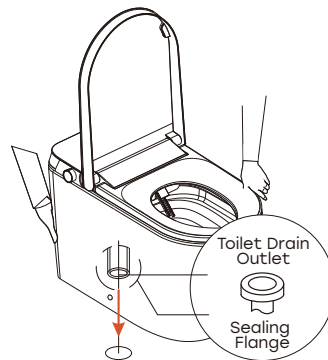

Insert the screw through the fixing sleeve, then through the holes on both sides of the ceramic toilet and into the mounting blocks on the ground. Tighten them securely using a screwdriver.

Put the decorative cap onto the fixing sleeve.

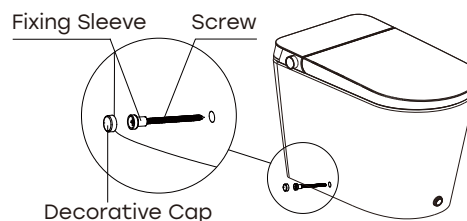
**Tips:**

- ✘ The toilet is heavy, and it needs two people to carry it.
- ✘ Please clean the drain outlet.
- ✘ Please make sure ceramic toilet outlet sits perfectly on the drain outlet.

6 Install the T-valve and water hoses

Connect the T-valve to the water supply (available in 9/16" adapter).
Use Teflon tape on all threaded connections to ensure a water tight seal.
Use gasket to prevent water leakage.

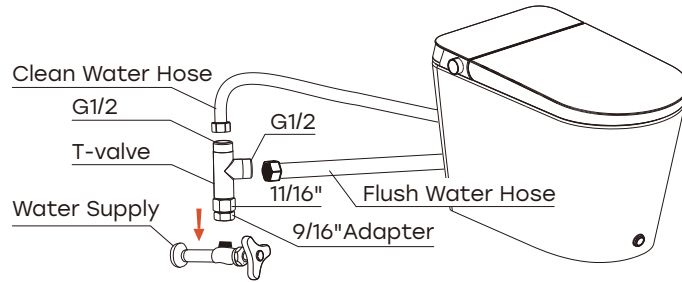

Note:
If your water valve is 9/16" (which indicates a 3/8" outlet actually), you could directly connect the T-valve; If your water valve is 1 1/16" (which indicates a 1/2" outlet actually), please screw off the adapter, then connect it.

Connect the larger flush water hose to the T-valve and tighten it.

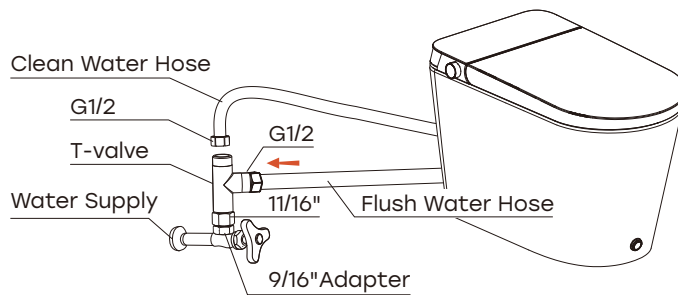

Connect the smaller clean water hose to the T-valve and tighten it.

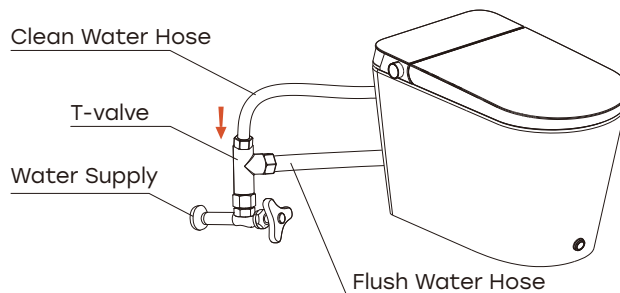

Installation of Battery

The batteries are primarily used for all the flush functions of the toilet. They are included in the product package. For any questions, please contact our Customer Service Team.

+ Install the batteries

1. Press the battery compartment cover to open it;
 2. Take out the battery box and unscrew the screw with a Phillips screwdriver to separate the upper and lower covers;
 3. Insert the new batteries needed according to the correct polarity, reinstall the battery box covers and tighten the screw securely;
 4. Put the battery box back into the battery compartment and close the compartment cover.
- ※ Pay attention to the length of the battery box connecting cable. Do not pull it excessively.
 - ※ 4 AA batteries are required. Do not mix new and old batteries.
 - ※ Batteries are non-rechargeable.
 - ※ The battery box is moisture-proof. Please ensure the fixing screw is securely tightened to maintain a good seal.

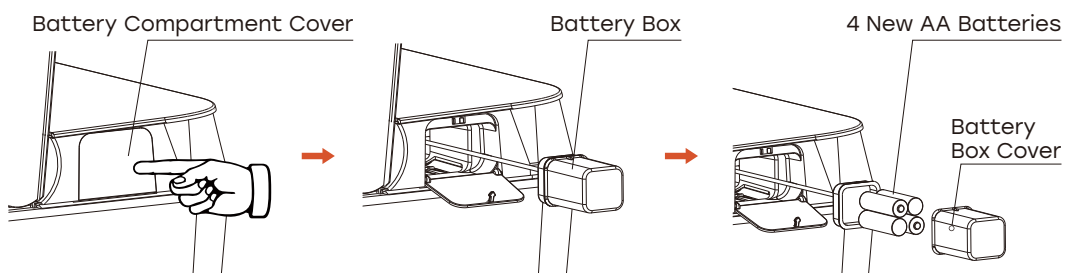

+ Replace the batteries

1. Press the battery compartment cover to open it;
2. Take out the battery box and unscrew the screw with a Phillips screwdriver to separate the upper and lower covers;
3. Replace the old batteries with the new ones according to the correct polarity, reinstall the battery box covers and tighten the screw securely;
4. Put the battery box back into the battery compartment and close the compartment cover.

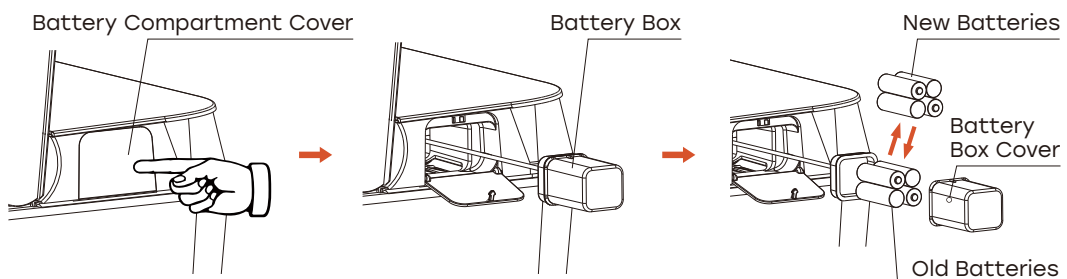

Product Test Run

1

Water Connection

Turn the water supply angle valve to the maximum opening, as shown in the diagram.

Make sure no leakage is found at various connection parts. Ensure the hose is not twisted or kinked.

※ In case of any water leakage, unfasten the nuts and install them again.

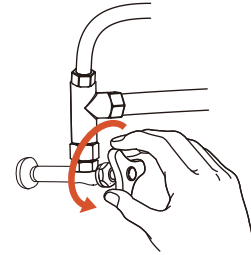
**2**

Bidet Toilet Running

Are all functions working properly?

Test all functions of the knob on the toilet.

Verify the normal operation of each function.

Kick the kick control to start a flush. Operate the knob and confirm the functionality of Posterior Wash and Feminine Wash (including water pressure adjustment).

All functions listed above should be tested. Please ensure all specified functions run correctly.

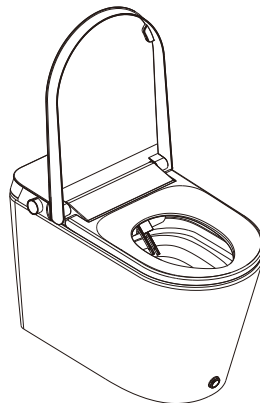

After the toilet is installed and the test run is completed, it is recommended that you apply the silicone sealant around the base of the toilet. Please avoid applying sealant where the access covers meet the floor.

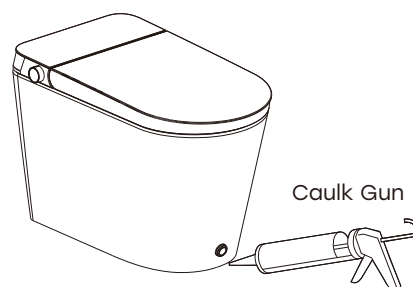

Usage Instructions

Function Explanations



Auto Flush

The toilet will automatically flush once after the user leaves the seat.

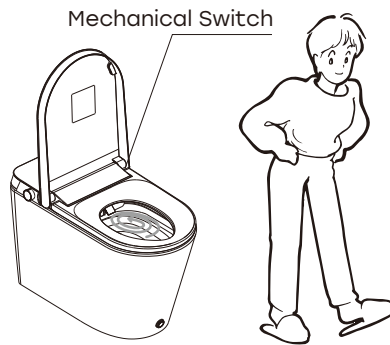

※ The seat uses a mechanical switch. When the seat is occupied, the switch closes and activates the bowl pre-wetting function. When the user leaves the seat, the switch opens and triggers the auto flush.



User-friendly Design

① **Pre-wet**

When the toilet seat is occupied, the product will flush automatically once towards the seat to moisten the toilet bowl.

② **Hygienic Seat**

The seat is made of hygienic material to ensure enhanced hygiene.

Kick Control Operations



Tap the kick control on the ceramic body with your foot to flush the toilet.



Knob Operations



Flush

Press the knob to flush the toilet.

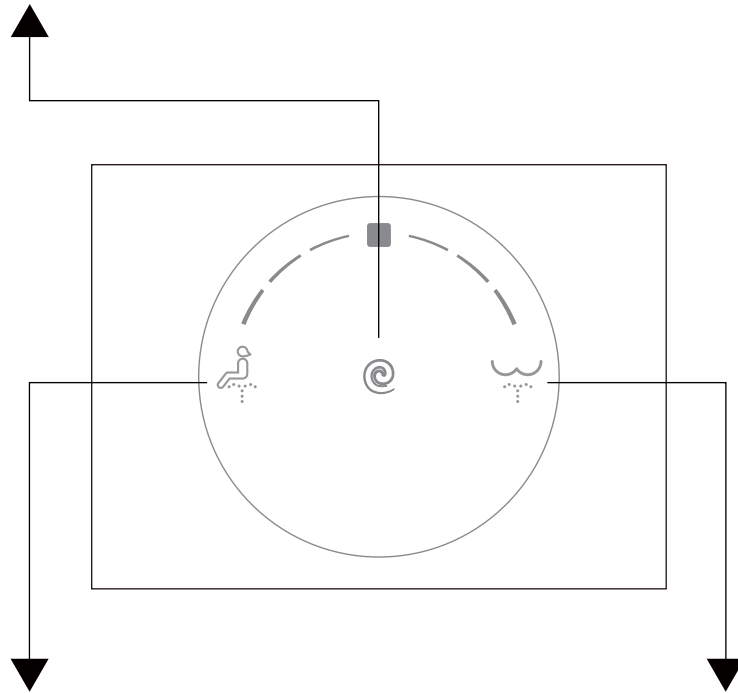

Feminine Wash

Rotate counterclockwise

Rotate the knob counterclockwise to start feminine wash.

During a feminine wash, rotate the knob counterclockwise to increase the water pressure, and clockwise to decrease it.

Rotate the knob back to the middle position to stop cleaning.

Posterior Wash

Rotate clockwise

Rotate the knob clockwise to start posterior wash.

During a posterior wash, rotate the knob clockwise to increase the water pressure, and counterclockwise to decrease it.

Rotate the knob back to the middle position to stop cleaning.

Daily Maintenance

Regular maintenance is required to ensure normal use.



Note:

1. Cut off the water supply before maintenance.
2. Direct water wash to the entire product is prohibited.

Maintenance of Ceramics, Seat and Lid

- + 1. Wipe dust or stains with a soft wet cloth.
- 2. A wet soft brush, cloth, or sponge may be used to clean the ceramic area.

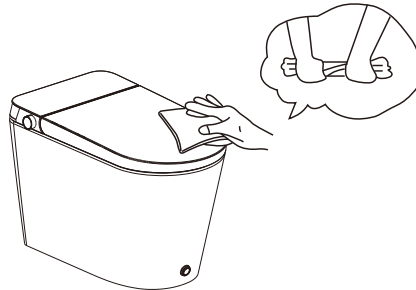

- ※ Do not use abrasive cleaners, such as alcohol, bleach, painter thinner, cresol, benzene, gasoline, etc.

Maintenance of the Nozzle

- + Pull out the nozzle gently. Hold it and wipe it with a soft cloth, sponge or small brush using a mild detergent.

- ※ Do not forcefully hold the nozzle, otherwise it may break.
- ※ Please replace the nozzle with a new one if it is clogged.

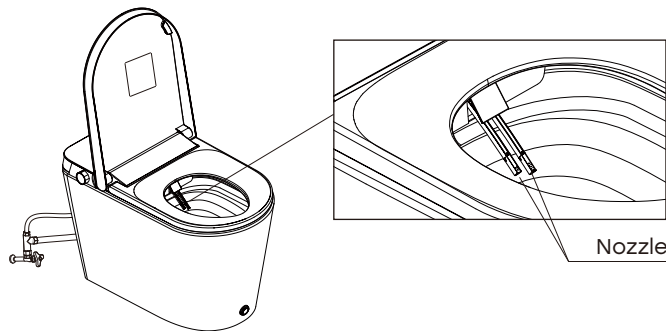

Maintenance During Winter Season

During the winter season, the water inside may freeze after long periods of storage and non-use. Please take measures to prevent.

- + **Note:**
 1. Before connecting the product to the water supply, allow it to defrost for 30 minutes in a warm indoor environment.
 2. In cases of extreme cold/freezing/nozzle stuck in place, wrap the water input line with a warm towel. Never pour hot water or use a hot dryer directly on the toilet.

Troubleshooting

This Troubleshooting Guide is for general aid only. If the user encounters any problems, please first consult the troubleshooting guide below. If the problem persists, please contact our Customer Service Team.

Scan the QR code for video resources and find the troubleshooting videos you need.



Knob		
Phenomenon	Fault Diagnoses	Solutions
Not working	Check whether the battery box is properly installed with the batteries	If the batteries are installed properly, replace the batteries or contact our Customer Service Team
Toilet Bowl		
Phenomenon	Fault Diagnoses	Solutions
The toilet does not flush cleanly when the water pressure is low	Check whether the pipeline is kinked	Please keep the water supply pipeline straight and smooth
There is no siphon and the toilet does not flush cleanly when water pressure is normal	Air leakage from drain	Contact a qualified plumber for assistance
	S-trap is blocked	Purchase a plunger from a local store to clear the blockage
Flush doesn't work when water pressure is normal	Flush valve failure	Contact our Customer Service Team
Others		
Phenomenon	Fault Diagnoses	Solutions
The lid/seat closes too fast	Damping and soft-close function failure	Contact our Customer Service Team

Specifications

Product Model		HOROW N30
Product Dimensions		28" (L) * 15-15/16" (W) * 18-1/2" (H)
Product Weight (lb.)		87.1 lb
Rough In Size		12"
Seat Height		17-1/4"
Bowl/Seat Shape		Elongated
Flush Type		Tornado flush
Gallons Per Flush (US gallon)		Single Flush: 1.22
Installation Type		Floor-mount
Rated Voltage		6 V
Rated Power		2.4 W
Water Supply Type		DN15 (G1/2)
Water Inlet	Inlet Water Temperature	33.8°F ~ 95°F
	Minimum Pressure	35 psi, ensuring a flow of water at least 5.28 GPM
	Maximum Pressure	108 psi (static state)
Flush Battery		Four AA batteries

Warranty

ONE YEAR LIMITED WARRANTY

HOROW products are made with high-quality materials and workmanship to provide customers with products that are built to last. If any defects in material or workmanship are detected during normal use within the first year of purchase, such as the replacement of any product or product part that you consider to be defective, HOROW will provide replacement parts free of charge. We are **not responsible** for all damages that result from **improper installation resulting in unavailability, repair and maintenance**. This warranty applies only to the original purchaser. Proof of purchase and **evidence of damage** will be required in the case of a **claim**.

HOROW recommends the installations to be made by a licensed, professional plumber.

HOROW will not be held responsible for any damage or product failure due to improper installation, misuse, or failure to use a licensed professional. HOROW is not responsible for any removal or installation cost.

This One Year Limited Warranty will be voided if:

The installation recommendations were not followed.

The product has been moved from its initial place of installation.

The product has been modified.

The product has been subjected to improper maintenance, abuse, misuse, excessive use of chemicals, accident or other damages.

HOROW makes no implication that products comply with any or all local building or plumbing codes. It is the consumer's responsibility to determine local code compliance. This warranty extends to the original purchaser and first consumer.

HOROW is not liable for any incidental, consequential or special damages associated with the return, replacement, installation or use of your product. This includes freight costs, labor, travel time, lost profit, home damages and other contingent liabilities and costs (including, without limitation, costs associated with experts, investigations, analyses, attorneys and other professionals and services).

The HOROW warranty is a comprehensive and explicit limit of liability, and all items outside of it are not addressable by or the responsibility of HOROW. Certain states have variances regarding implied warranties and in those situations, we remain fully compliant.

Warranty Registration

Proof of purchase is required to validate this limited warranty. HOROW encourages you to register your product upon purchase to create a record of ownership at www.horow.com. Registration is voluntary and not required to maintain your limited warranty rights.



For any questions or claims, please contact us by phone or email.

Phone: (+1)209-200-8033

Monday to Friday

Email: support@horow.com

When making a claim, please prepare a photo of the evidence of damage so that we can quickly resolve the claim for you.



Warning

Content may contain sharp and other possibly harmful pieces and may cause hazard to children and adults, HOROW is not responsible in any way for personal damage.