

# ASSEMBLY INSTRUCTIONS & PARTS IDENTIFICATION

## Hardware kit

Ltr	Qty	Description
A	4PCS.	BOLT ØM6X16MM
B	4PCS.	BOLT ØM6X45MM
C	4PCS.	FLAT WASHER
D	1PC	ALLEN WRENCH
E	1PC	SUPPORT BRACKET

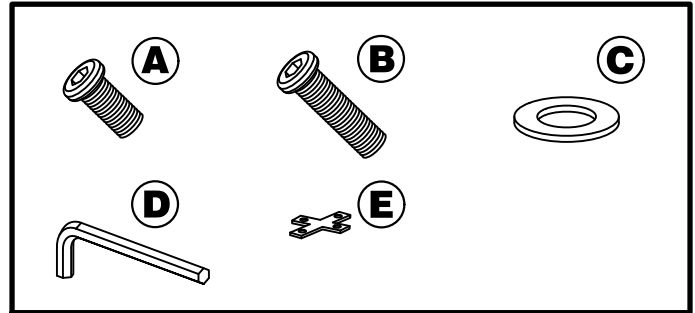

### STEP 1:

Carefully place the upper leg and the lower leg assemblies together upside down to prevent scratches on the legs as shown in Step 1.

Connect the legs with the support bracket E and bolts A. Do not fully tighten at this point

## Parts Key

No	Code	Qty	Description
1	A	1PC	UPPER LEG ASSEMBLY
2	B	1PC	LOWER LEG ASSEMBLY
3	C	4PCS.	FLOOR LEVELER

### STEP 1:

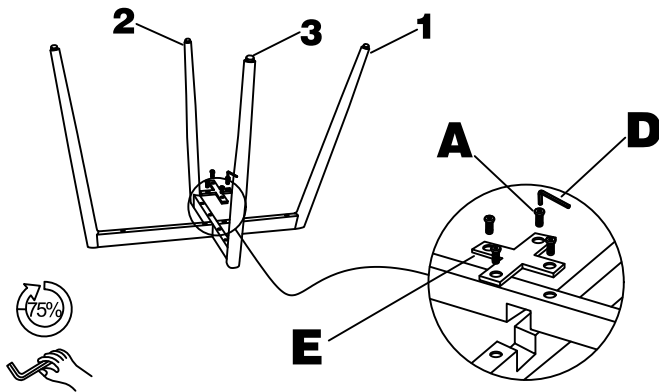

### STEP 2:

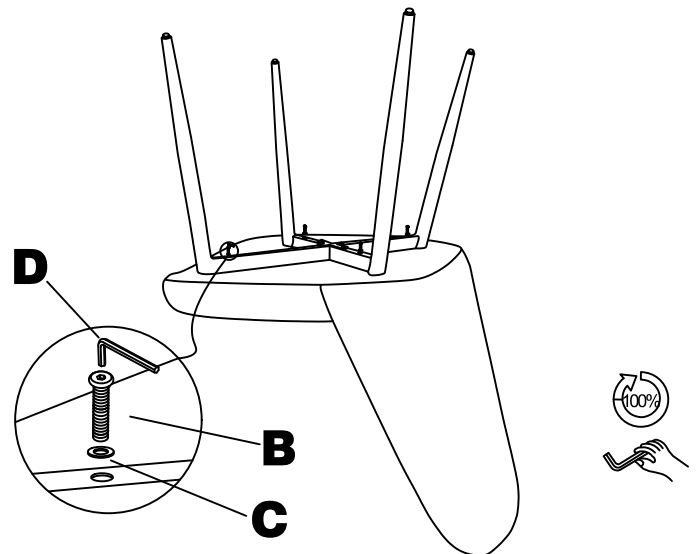

### STEP 2:

- . Attach the assembled legs to the seat by inserting a flat washer and bolt B per the diagram.
- . Do not fully tighten the bolts until all are in place.
- . Once all bolts are in place, fully tighten the bolts by hand using the provided Allen Wrench. Do not use a power tool to tighten.
- . Use the floor levelers to level the chair, if needed.

### \*\*\* FABRIC CARE:



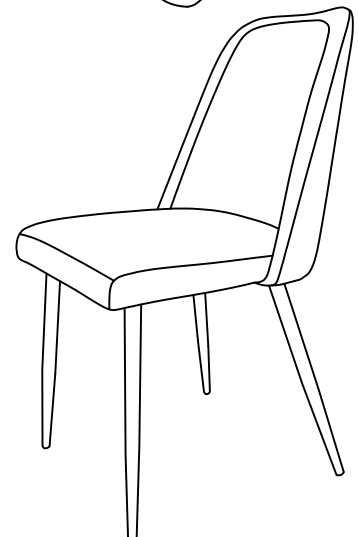

Avoid direct sunlight, water, oil, acid, sharp objects etc. Use a vacuum cleaner to clean. Wipe spills immediately. If needed, spot clean with a mild water-based soap. Wipe dry with a clean cloth  
Fabric content 100% Polyurethane, Cleaning code W



# ASSEMBLY INSTRUCTIONS & PARTS IDENTIFICATION DINING TABLE

**Thank you for purchasing this quality product. Be sure to check all packing material carefully for small parts that may have come loose inside the carton during shipment**

Key Parts			
No	Code	Qty	Description
1	TT	1 pc	Table top
2	L	4 pcs	Leg
3	FLV	4 pcs	Floor Leveler

Hardware kit			
No		Description	Qty
A		Flat washer	8 pcs
B		Lock washer	8 pcs
C		Bolt 8x30mm	8 pcs
D		Key wrench	1 pc

