

Casta Diva[®]

USER MANUAL

Intelligent Toilet

A200T-S

Thank you for placing your confidence in us.

Thank you for buying our products. You can learn from this manual about the use of products and other important issues before initial start-up.

Please follow the instructions in this manual carefully.

Please keep the manual properly stored for future reference.

Regarding future product updates, the product is subject to change without prior notice.

Illustrations in this manual serve as visual demonstration.

We hope you can learn how to use the product through this manual.

In order to guarantee that the Product will always function optimally, and to ensure your personal safety, please do the following:

Read these operating instructions carefully before initial start-up and follow these instructions!

Get free lifetime technical support

CONTENT

Safety Notice	1
Introduction	4
Overview	4
Main	4
Operation	5
Main	5
Remote Control	6
Operation Knob	10
Clean & Maintenance	11
Nozzle Cleaning	11
Filter Cleaning	11
Surface Cleaning	11
Long Time No Use	12
Winterization	12
Replace Batteries	13
Soap Solution Replenish	14
Troubleshooting	15
Technical Data	18

SAFETY

CAREFULLY READ AND OBSERVE THE FOLLOWING SAFETY INSTRUCTIONS BEFORE USING!

WE WILL NOT BEAR ANY RESPONSIBILITY FOR DAMAGE OR LOSS RESULTING FROM FAILURE TO OBSERVE THE FOLLOWING SAFETY INSTRUCTIONS.

- This device is an electric appliance of class I and must be connected to a grounding system.
- **Individuals with disabilities and (or) limited cognitive ability (including children), or those who do not have the necessary knowledge of use, shall not use this product alone. These people must use this product under the strict supervision and guidance of adults who can be responsible for their safety. Please take care of children to ensure that they do not operate this equipment.**
- The device is an electrical apparatus and thus shall not be used in a wet or humid environment. If the device is used in a bathroom, an exhaust fan or air vent shall be installed to ensure sufficient airflow.

Symbols description

Symbol	Description	Symbol	Description
	Alternating Current		Danger! High risk, lethal hazards, severe injuries
	Direct Current		Warning! Medium risk, severe injuries
	Ground		Caution! Low risk, minor injuries
	Note! Damage to property		

Danger!

To reduce the risk of electrocution or fire

- The socket circuit connected to the product must have residual current protective device with a rated residual operating current not exceeding 30mA.
- Please install the ground wire correctly in accordance with the relevant regulations of the state.
- Ensure that sockets and plugs are located at least 23.6in horizontally from the shower room or bathtub.
- Do not place or submerge the intelligent toilet or its components into water or other liquids. If it happens inadvertently, do not reach for any electrical components of the intelligent toilet. Unplug toilet immediately.
- Please unplug unit immediately and contact your dealer or call service hotline for replacement if cord becomes damaged. It must be replaced by the manufacturer, its service agent or similar qualified persons.

SAFETY

Warning!

To reduce the risk of burns, electrocution, fire, or injury to persons

- Do not allow to use a loose socket.
- Do not allow to handle the power cable or plug with wet hands.
- Do not allow the power cable or plug to be optionally pulled.
- Do not allow to place open flames, candles, cigarettes, or similar objects on or by the toilet.
- Do not allowed to place heavy objects or step on the top cover or seat ring.
- Please close the seat temperature when sitting on the toilet for a long time. When the following people use the product, others should turn off the temperature of the seat: The child, the aged, or the person who do not know how to adjust the seat temperature; the people who have limited physical, sensory or mental capabilities, and other person without freed mobility; the person who have taken a drug (sleeping pills, Cold Remedy, etc.) that may cause drowsiness; the people with an overdose of alcohol, exhaustion, or unconsciousness.

Caution!

To reduce the risk of malfunction or damage of product

- Do not allow to use industrial water, circulating water or waste water as the source of the product. Please use the water source that meets the standard of living and drinking.
 - Do not allow the inlet-hose to be severely pinched, bent, or kinked.
 - Do not allow to use harsh or abrasive cleaning substances such as abrasive cleansers, scouring powder or drain cleaner on your ceramic surfaces. Also avoid using steam cleaners and hard, abrasive sponges. The use of acidic cleaners with a pH value between 1 and 4 is highly recommended.
 - Do not allow to reuse old hose-sets. Please use new hose-sets supplied with the appliance.
 - Do not allow to hit against the ceramics.
 - Do not allow to place the product upside down.
 - Do not use radio equipment near the product.
 - Do not allow to plunge into the news paper, paper diaper, sanitary napkins, etc., which are easy to block the product.
 - Do not allow to make remote control contact with water.
 - Disconnect the main plug before you start with cleaning the product. Please use dry cloth when cleaning the power plug.
 - Do not allow to expose the product directly to sunlight, as it may cause fading or unstable toilet temperature.
 - Do not install the intelligent toilet in rooms where the temperature will be less than 4°C (39°F).
 - Do not lean on the toilet cover while using it or it may damage the cover.
-

SAFETY

Information on the use of batteries

- Clean the battery and contacts before inserting the battery. Clean with wet cloth when necessary, and make sure the batteries are oriented properly after drying.
- Do not insert new and old batteries together in the remote control.
- Do not insert batteries with different chemical properties or brands, which may lead to the over discharge of the battery in use and increase the possibility of leakage.
- Do not attempt to recharge non-chargeable batteries for use with unit.
- Do not have battery in short circuit, heated, thrown into fire or disassembled.
- Do not expose the batteries to hot surfaces or direct sunlight to reduce the risk of battery leakage.
- Please discard the waste battery according to the principle of garbage classification.
- Please be sure to use alkaline batteries to reduce the risk of battery leakage.
- Remove the batteries if you do not use the remote control for an extended period to reduce the risk of battery leakage.

INTRODUCTION

Overview

A200T-S

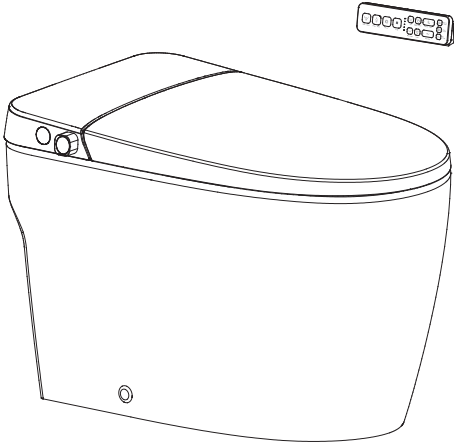

Main

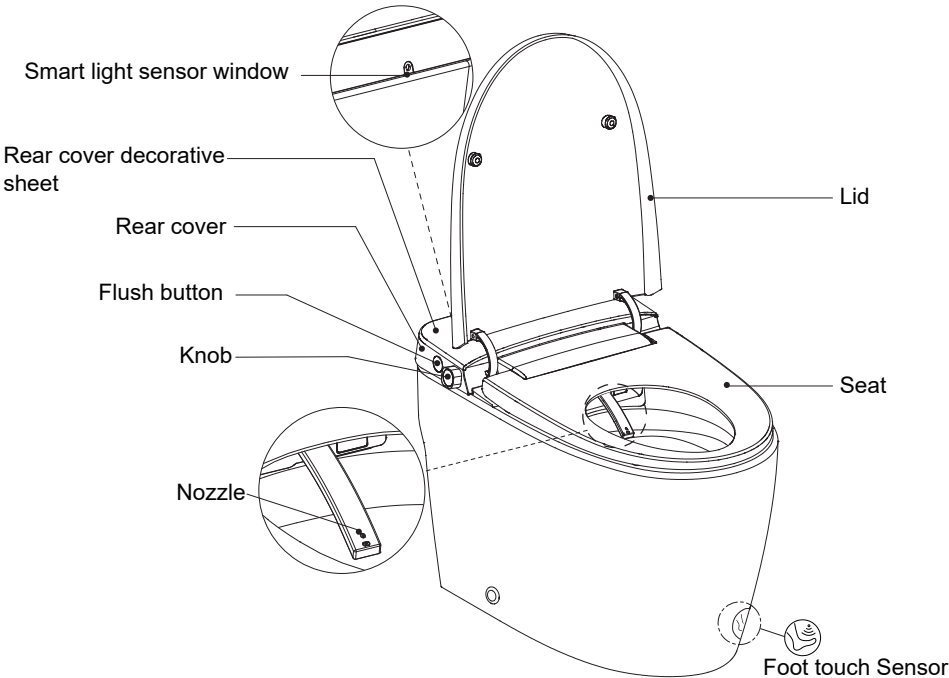

OPERATION

Main

- **Seat:** When sitting, must touch the seat ring sensor position, so that the product function can run normally.
- **Nozzle self-cleaning:** When the seat, cleaning, start and stop, automatically start nozzle self-cleaning.
- **Prompt tone:** This function is enabled by default after the host is powered on. You can set this function by remote control. When the prompt tone is set to on: When a valid command is received, the host will emit a short prompt tone. When receiving an invalid command, the host will issue two short prompts. When it is adjusted to the maximum or minimum status, the product will emit a long prompt tone.
- **Intelligent Control:** The function is turned off by default after power on, and can be set by remote control. When the intelligent control mode is turned on, the system will learn independently, so that the water temperature, seat temperature and air temperature will be intelligently adjusted with the change of the ambient temperature.
- **Intelligent power-saving:** After the host is powered on, this function is turned off by default and can be set through the remote control. After the intelligent power-saving function is turned on, the system will learn autonomously to intelligently heat the seat ring according to the user's usage habits.
- **Deodorization:** This function is turned on by default after powered on and can be set through the remote control. When the deodorization function turned on, deodorization will start automatically after the seat self-cleaning, stop automatically during the cleaning period, and stop automatically after 30 seconds from the seat.
- **Automatic flush:** Keep sitting for more than 5 seconds, then leave the seat, flushing will start automatically after leaving seat for 15 seconds. (Default setting)
- **Anti-low temperature scald:** After sitting for 5 minutes, the seat temperature will automatically turn down until 29°C(84°F).
- **Night light:** Intelligent night light is turned on by default after powered on and can be set through the remote control. In the smart night light mode, the night light is automatically turned off or on according to the intensity of the ambient light.
- **Spray nozzle UV sterilization:** The sterilization will automatically start after the human body is seated for 10 seconds, and will be turned off after 120±5 seconds. After seating, UV sterilization automatically shuts off. Automatic sterilization cannot be set currently, and intelligent sterilization is enabled by default.

OPERATION



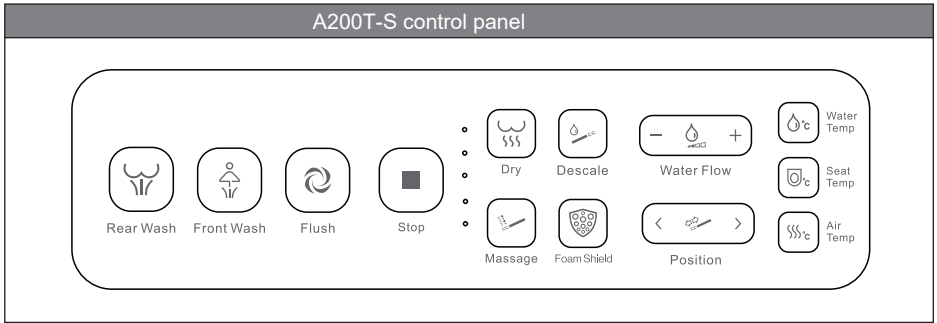



Remote control



Function	Logo	Operation	Remark
Pairing	■	Remove all batteries from the remote control, cut off the power to the toilet for more than 30 seconds, then turn on the power to the toilet. Wait for the toilet to emit three short beeps, and the night light on the toilet will flash, entering pairing mode. Immediately install the remote control battery, wait for the gear indicator light turn off, and continuously press the [Stop] key until the toilet emits a feedback sound, indicating successful pairing. If the toilet emits two long beeps and the night light stops flashing, but the pairing is still unsuccessful, it needs to be re-paired.	When replacing the remote control, it is necessary only after you replaced your remote control. Please make sure there is sufficient power supply for the remote control before pairing.
Rear wash		After you are seated, press the [Rear wash] key to start.	If not stopped manually the Rear Wash/Front Wash will stop automatically after 3 minutes.
Front wash		After you are seated, press the [Front wash] key to start.	
Stop	■	Press the [Stop] key to stop the wash, clean and dry function in progress.	/
Flush		Press the [Flush] key to start flushing.	/
Dry		After seating, press [Dry] key, initiate drying function.	When using the drying function, it is recommended to wipe off larger water droplets with a paper towel first. Drying function will continue about 3 minutes.

OPERATION

Remote control

Function	Logo	Operation	Remark
Massage		When cleaning, press the [Massage] key to start mobile massage; press [Massage] key again to start strong and weak massage; press the [Massaged] key for the third time to start strong & weak and mobile mixed massage; press the [Massage] key for the fourth time to stop massage and cycle like this.	/
Foam shield		Press the [Foam Shield] key to start foam shield function.	/
		Long press the [Foam Shield] key for 3 seconds, the foam shield function when seated automatically will be turned on/off.	/
Foam duration setting		Long press the [Stop] and [Foam Shield] keys for more than 3 seconds to enter the foam shield foaming duration setting mode and display the current setting status. Short press the foam shield key again, and switch to one mode every time you press it. There are three modes in total: short, medium and long. Cycle through this mode.	Short display one indicator light, medium display two indicator lights, long display three indicator lights.
		Long press the [Stop] key for more than 3 seconds to exit the setting mode, or if no button is pressed within 20 seconds, it will automatically exit the setting mode.	There are 3 gears in total, with the default being the long gear.
Manual cleaning		When not seated, press the [Descalc] key to turn on the manual cleaning function, the nozzle extends and please clean the nozzle with a soft cloth. The nozzle will remain for 3 minutes, then retract and manual cleaning will end.	During the operation of the cleaning function, if the person sits down or presses the [Stop] key, the nozzle will retract and manual cleaning will end. (For A200T-S only)
Air temp		Press the [Air Temp] key to set the current gear, then press the [Air Temp] key again, to increase the air temp, at the same time, the gear indicator light has correspondingly added. When the air temp reaches the highest gear, press the [Air Temp] key again, air temp closed; All indicator lights are off, repeat this cycle.	There are 4 gears in total, and the second gear is default after power on.
Water temp		Press the [Water Temp] key to set the current gear, then press the [Water Temp] key again, to increase the water temp, at the same time, the gear indicator light has correspondingly added. When the water temp reaches the highest gear, press the [Water Temp] key again, water temp closed; All indicator lights are off, repeat this cycle.	There are 4 gears in total, and the second gear is default after power on.







OPERATION

Remote control

Function	Logo	Operation	Remark
Seat temp		Press the [Seat Temp] key to set the current gear, then press the [Seat Temp] key again, to increase the seat temp, at the same time, the gear indicator light has correspondingly added. When the seat temp reaches the highest gear, press the [Seat Temp] key again, seat temp closed; All indicator lights are off, repeat this cycle.	There are 4 gears in total, and the second gear is default after power on.
Water flow		Press the [+] or [-] key on the water volume to increase or decrease the flow rate, while the indicating light will adjust accordingly.	There are 5 gears in total, and the third gear is default after power on.
Position		Press the [>] or [<] key on the nozzle position to move the nozzle forward or backward, while the indicating light will adjust accordingly.	There are 5 gears in total, and the fifth gear is default after power on.
Sound on/off		Long press the [Stop] and [Water temp] key together for more than 3 seconds, initiate/close the prompt tone during using operation prompt tone.	/
Eco mode		Long press the [Stop] and [Seat temp] key together for more than 3 seconds, initiate/close the Intelligent power saving function.	/
Temperature intelligent control		Long press the [Stop] + [Air Temp] keys for 3 seconds, temperature intelligent control on/off.	Default closed. In this mode, the system will learn autonomously to intelligently adjust the seat temperature, wind temperature, and water temperature according to changes in ambient temperature. To ensure the effectiveness of use, please turn off the intelligent power-saving function before enabling this function.
Running water replacement		Long press [Stop] + [-] keys for more than 3 seconds to turn on running water replacement function, the nozzle does not extend all waterways are replaced with running water, hold for 90+5 seconds and the running water replacement ends.	During the operation of running water replacement, press the [Stop] key on the remote control to turn off the running water replacement.
Deodorization		Long press [Stop] and [+] key for more than 3 seconds to start or close the deodorizer function.	/
Auto flush after lid & seat closed		Press and hold the [Open/Close] key and the [Flush] key for 3 seconds to open/close the auto-close flush function. A short beep sounds when opening; a long beep sounds when closing.	This function is turned off by default. In the auto-close flush mode, the cover will be closed before flushing.
Night light		Press the [Massage] key for 3 seconds, the night light will cycle between Smart, Normally On, and Closed.	Block the smart light sensor window, the night light does not light showed the function was closed.

OPERATION

Remote control

Function	Logo	Operation	Remark
Sleep standby mode	 	Long press the [Stop] and [Massage] keys for more than 3 seconds to enter sleep mode, and when turned on, a short short prompt sound will be heard.	Short press the knob or Sitting down to exit standby mode.
Off-seat flush time setting	   	Long press the [Stop] and [Flush] keys for more than 3 seconds simultaneously to enter the flush time setting mode. Then press the [+] or [-] key to increase or decrease the flush time, and the indicator light will increase or decrease correspondingly.	Total 4 modes: close, 5 seconds, 10 seconds, 15 seconds.
		Long press the [Stop] key for more than 3 seconds to exit the setting mode, or no press within 20 seconds to automatically exit the setting mode.	/

CLEAN & MAINTENANCE

Nozzle cleaning

When the human body is not seated, press the [Clean] key (only for A200T-S) or long press the [Stop] key and the [<] key for more than 3 seconds, and the nozzle will extend to clean the nozzle. Gently hold the nozzle and use a soft cloth, sponge, or small brush dipped in neutral cleaning agent to wipe the nozzle. After sitting down or pressing the [Stop] key, or after 3 minutes, the nozzle will retract.

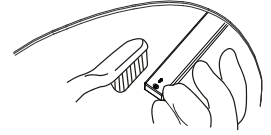

Filter cleaning

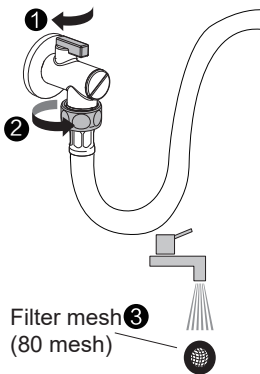

The filter screen needs to be cleaned frequently. If the unit does not fill up properly, starts to lose pressure, or does not function normally, please clean the filter first.

- !** Please make sure to use a filter mesh, otherwise it may result in inability to provide warranty. Please ensure that the water inlet switch is turned off during the cleaning process. After cleaning, please put it back the filter mesh in reverse order.

Surface cleaning

- ⚠** Turn off the power before cleaning!

Please use a smooth sponge or soft cloth dipped in some water or neutral cleaner and wipe the surface of the product after wringing it out. Please lift the cover and seat when cleaning other areas with the cleaner. The cleaner must be completely removed from the ceramic before closing the cover and seat. Otherwise, evaporation of the cleaner may corrode the ceramic surface.

CLEAN & MAINTENANCE

Long time no use

If this product will not be in use for an extended period of time, please operate as following:

- Disconnect the electrical power, stop the electricity.
- Close the angle valve to stop watersupply.
- Remove the water inlet hose from the tee pipe and drain the water from the water inlet hose.
- Close the lid, use a flat-head screwdriver to pry open the main engine from the gap in the back cover, and then take it out upward, as picture 1.
- Turn the bottom of the main machine down as picture 2, and drain the water by rotating the drain plug in the direction of the product logo with a screwdriver. After the water is drained, re-screw the drain plug, as shown in picture 3. Unscrewed drain plug will result in water leakage upon re-use.
- Before reinstalling (put it back) the host, please push this lever in the direction of the arrow as shown in picture 4 to ensure that the internal protection switch is in the reset state.

! When draining water, shaking the machine horizontally is good to drain out the water.

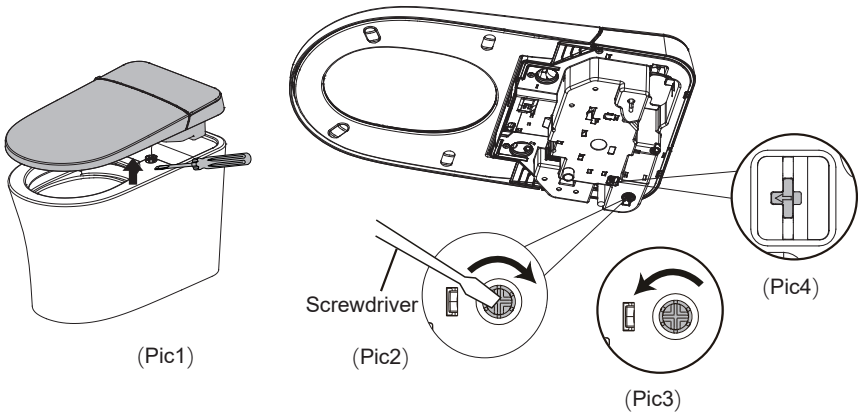

- Install the smart seat and water inlet hose back to their original positions.
- Remove the battery of the remote control and store the battery separately. The battery should be put in a place that is not easy for children to reach to avoid accidental ingestion.

! Before using the product again, test and confirm it according to "TEST" in the Installation Manual.

Winterization

Please ensure water temperatures will not drop below 4°C (39°F). Frost or frozen water will damage the system and may lead to water leakage. If the water or ambient temperature drops below 4°C (39°F), please discontinue use of product and operate as following steps:

- Disconnect the electrical power or press the leakage protector test key.
- Close the angle valve to stop watersupply.
- Draining inside water as the manual mentioned former.

! If water not drained may result in product damage and water leakage.

Condensation forms when product is moved from a cold place to a warm place. Please let it stand for a few hours before connecting with water and electricity.

CLEAN & MAINTENANCE

Replace batteries

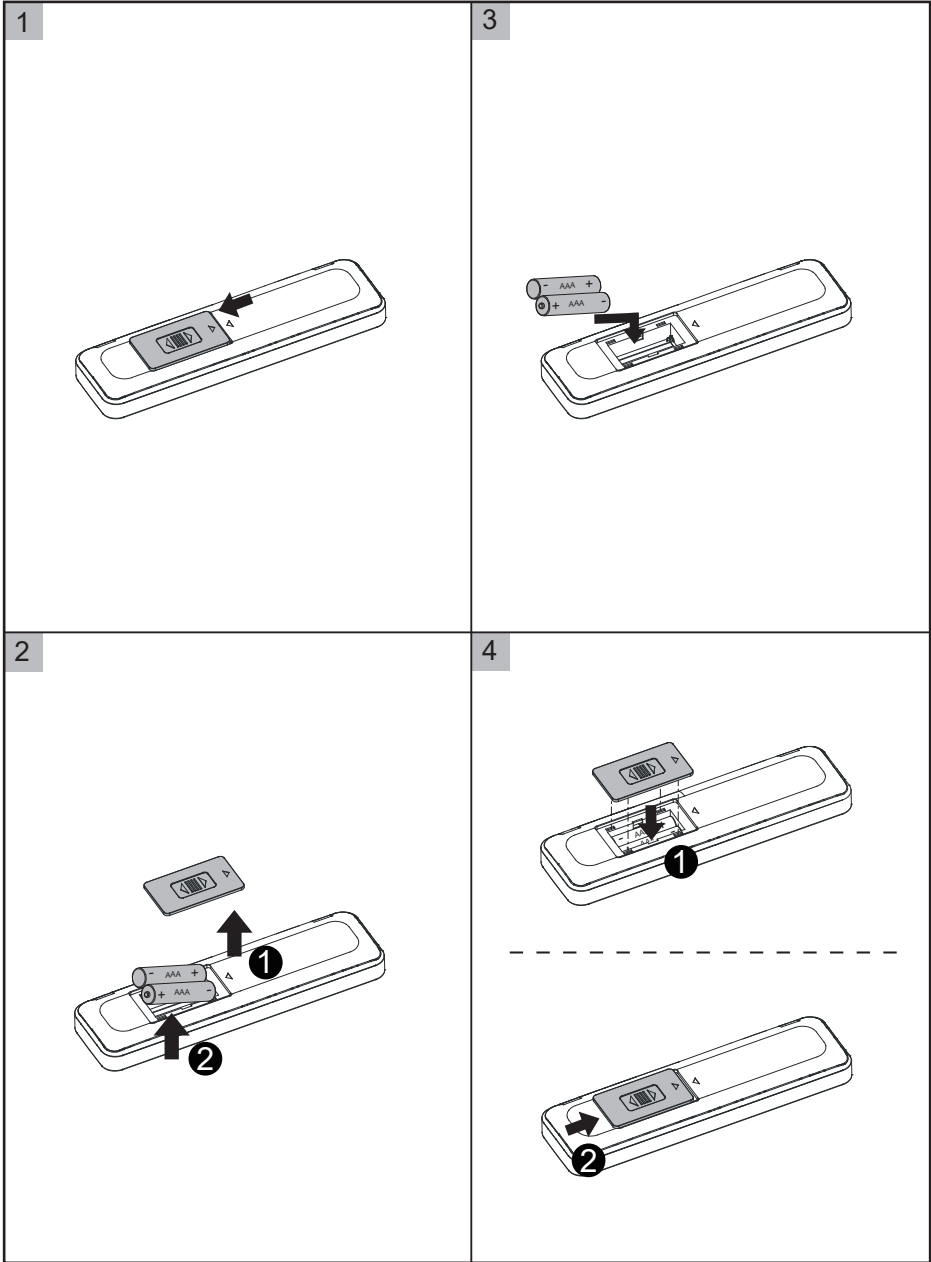

CLEAN & MAINTENANCE

Soap solution replenish

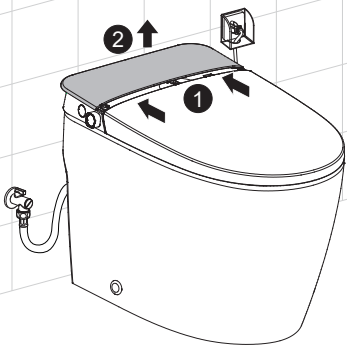
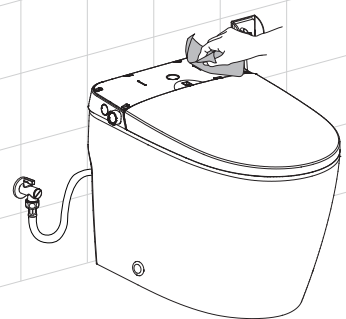
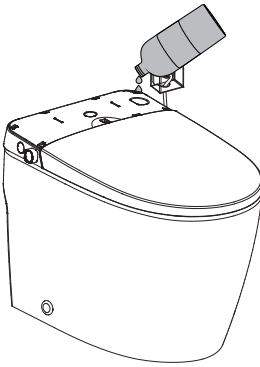
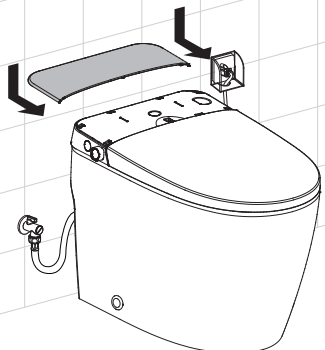
<p>1</p> 	<p>3</p> 
<p>2</p>  <p>! Soap selection: 1. Please give priority to the detergent with large foaming capacity. Use different brands of soap solution, the foaming effect and use times of foam guards are different. 2. If the ambient temperature of the product is below 6°C(43°F), it is recommended to use a 5:1 mixture of soap and water to avoid freezing of the soap due to low temperature, which may affect the effectiveness of use.</p>	<p>4</p> 

TROUBLESHOOTING



In case of minor malfunctions, please refer to the following solutions. If the below solutions do not resolve the issue, please contact customer support for further examination and repair.

Notice: In case of water leakage, please cut off the power and shut off the water inlet valve immediately.

- Before checking whether the product is faulty, check the following items:

Check the power supply

Check water supply

If the power supply could work normally

If the water supply could work normal

Whether the plug is inserted or not

If the angle valve is shut off

Whether the leakage protector trips

- If any of the following symptoms occur, disconnect the power supply immediately.

Hearing continuous "beep"

The leakage protector trips frequently

■ No function

Malfunction	Cause	Solution
No function	Product in Stand-by mode.	Short press the host knob or sit down to exit standby mode.

■ Remote control

Malfunction	Cause	Solution
Remote control does not work	Battery in low.	Replace batteries.
	Battery wrong oriented.	Reinstall batteries with correct oriented.
Remote control works but does not control toilet	Battery in low.	Replace batteries.
	Control is too far from product, or out of range.	Please use the remote control within 6.56ft range to the product.

■ Dry function

Malfunction	Cause	Solution
Does not work	No detect to seat.	Initiate dry function after taking seat.
Stop during use	Operating over 3 minutes.	Restart dry function.
	Users move out from sensor area.	Take seat and restart dry function.

■ Massage

Malfunction	Cause	Solution
Press the remote control [massage] , massage function does not work.	Fail to open clean function.	Press [massage] when in cleaning.

■ Auto flush

Malfunction	Cause	Solution
No function	On seat time is less than 5 seconds.	On seat time is longer than 5 seconds.

■ Seat heating

Malfunction	Cause	Solution
Seat no heating	Seat heating function is off.	Press the [Seat temp] key on remote control, and then press [+] key.
	Under ECO mode.	Long press the remote control [Stop] and [Seat temp] keys for more than 3 seconds.

TROUBLESHOOTING

■ Cleaning

Malfunction	Cause	Solution
No wash	No detect to seat.	Initiate wash function after taking seat correctly.
Nozzles stretch out slowly	Normally need 5 seconds.	Function OK.
Low water volume	Filter blocking.	Clean the filter.
No heat for initial use	When stock and transport, high temp, TEMP control was cut off and heating cannot work.	Press the reset push rod on the host base to reset. (For details, please refer to Pic 4 for details on long-term non use in cleaning and maintenance)
Nozzles stop spraying and stretch back	Keep sparying up to 3 minutes limitation.	Restart the cleaning function.
	Users moved and lead to no detection of seating status.	Initiate wash function after taking seat.
	Water&Electric supply were abnormal, water over-heated and cause the self-protection.	When water and electric return OK, restart the system.

■ Deodorization

Malfunction	Cause	Solution
No function	User did not touch the sensing on the seat.	Please take a seat to touch the sensor on the seat ring.
	Machine is in cleaning mode.	Function OK. The deodorization function is automatically turned off during cleaning.
	Mal-operation the remote control disables the deodorization function	Press [Stop] and [+] keys.
Keep operating after leave the seat	When leave seat, deodorization will last for another 30 seconds.	Function OK.

■ Night light

Malfunction	Cause	Solution
No night light	Night light was set to close.	Set module to smart status.
	Night light in smart mode, light in the room is too bright.	Function OK.
The night light is steady on and cannot be turned off	Night light in smart mode, light in the room is too dark.	Function OK.
	Set the night light to normally open.	Set to the desired state.

■ Nozzle clean function

Malfunction	Cause	Solution
Stretch back automatically	Nozzle stretching time up to 3 minutes.	Restart the cleaning function.
When not sitting, rotate backward the knob on base,the nozzle spraying automatically.	Sensor area covered by certain substance, water, damp water etc.	Clean the sensor area.

■ Auto open lid

Malfunction	Cause	Solution
Can not open automatically	After manually closing the lid, no object movement within the toilet sensor area is less than 10 seconds.	Try again after 10 seconds without object movement.
	There is a conductive medium at the position of the seat ring sensor, such as water droplets or wet paper.	Clean the conductive medium on the seat ring thoroughly.

TROUBLESHOOTING

■ Foam shield function

Malfunction	Cause	Solution
When the foam shield is turned on, no foam flows out from the base nozzle.	Filter blocked.	Please clean the filter.
	Foam shield module waterway blocked.	Please contact the local dealer or call the service hotline.
	Other component failures.	Please cut off the power, stop using the product, contact the local dealer or call the service hotline.
When the foam shield is turned on, only water or a small amount of foam flows out.	Soap box without soap solution.	Please add soap solution according the manual.
	The outlet of the soap box is blocked.	Please contact the local dealer or call the service hotline.
	When the room temperature is below 6°C (43°F), some soap solutions freeze, resulting in a significant decrease in foam production.	Please add an appropriate amount of warm water at about 50°C (122°F) into the soap solution box (add it to about 90% of the volume), stir it evenly and restart the foam guard several times, then the freezing phenomenon can be eliminated.
	Other component failures.	Please cut off the power, stop using the product, contact the local dealer or call the service hotline.
When the foam shield turn on, the foam column is intermittent	When starting the foam guard for the first time, air is discharged from the soap solution box.	This is a normal phenomenon and will be resolved after a few uses.
	When the foam shield function is not used for a long time, the soap liquid may dry up. When the function is started again, it will be intermittent.	It is a normal phenomenon. After adding soap solution again and standing for a period of time, this phenomenon will be eliminated after using the foam shield several times.
	Just finished the flushing function, the product is still in water replenishing state.	Please wait for the completion of water replenishment before starting the foam shield.

TECHNICAL DATA

Items	Description
Flush Volume	3.8L(1.0gpf)
Rated voltage	AC120V, 60Hz
Rated power	910W(Inlet TEMP 59±2°F; flow rate 0.136-0.141GPM)
Max power consumption	1500W
Cable length	About 4.2ft
Applicable water pressure (Static pressure)	0.14MPa-0.86MPa(20PSI-125PSI)
Applicable water TEMP	4°C-35°C(39°F-95°F)
Applicable TEMP range	4°C-40°C(39°F-104°F)
Cleaning volume	0.119GPM-0.145GPM(static pressure 29PSI)
Water TEMP adjustment	Intelligent mode (35°C-39°C/95°F-102°F), 4 levels setting room temperature/35°C(95°F)/37°C(98°F)/39°C(102°F)
Seat Temp adjustment	Intelligent mode (33°C-37°C/91°F-98°F), 4 levels setting room temperature/33°C(91°F)/35°C(95°F)/37°C(98°F)
Warm wind adjustment	Intelligent mode (38°C-46°C/100°F-115°F), 4 levels setting room temperature/38°C(100°F)/42°C(108°F)/46°C(115°F)
Heating power	1400W
Seat heating power	50W
Warm wind power	300W
Wind volume	≥8.83CFM
Nozzle & Seat	Anti-bacterial material
Water proof	IPX4
Size (length, width and height)	680×393×479mm(26.8x15.5x18.9in)
Maximum load (Seat and lid)	150kg(330lbs)