



## Designer Collection Tubs

**Andrea® 6**  
**MODEL # 96**  
**60" x 32" x 18.25"**

### GENERAL SPECIFICATIONS

**Material** - Acrylic  
**Installation** - Drop-in or Undermount  
**Plumbed Weight** - 100 lbs / 45 kg  
**Soaker Weight** - 75 lbs / 34 kg  
**Average Fill** - 30 gal to above jet level  
**Maximum Fill** - 57 gal to overflow

NOTE: Filling this tub to the maximum may require an above average size or dedicated water heater.

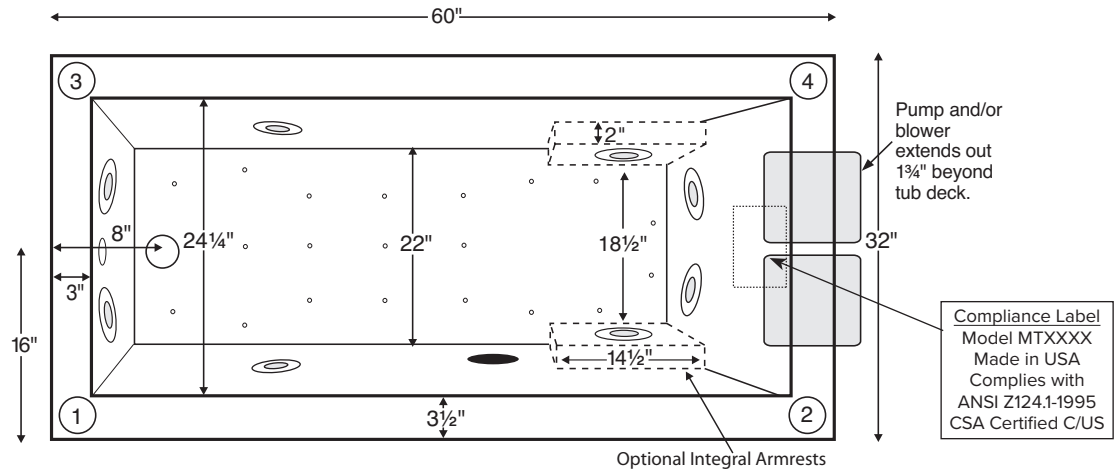

Numbered areas on tub deck represent possible locations to install cleaning systems, faucets and other fixtures.  
**Pump extends out approximately 1 3/4" beyond tub deck.**  
 Shown with Air Massage and Ultra Whirlpool Package.

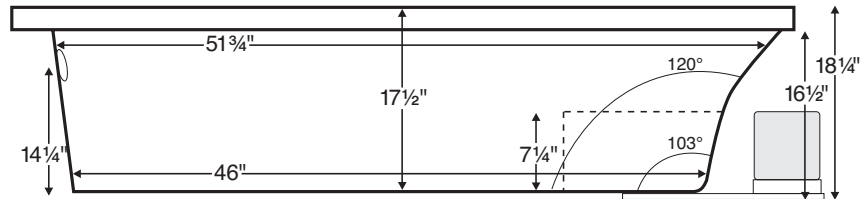

**IMPORTANT:**  
 Air baths and tubs with a pre-leveled foam base or frame system add 2-3" to overall tub height.

### IMPORTANT ORDERING & INSTALLATION INFORMATION

- Before ordering or installing, please consider future access to equipment.
- Add proper bedding compound to fully level and support bottom of tub.
- When equipped with an air bath package, pre-leveled foam base or frame system, overall tub height is increased by approx. 2-3" and is designed to install on a flat, level subfloor.
- Radiance placed on airbath floor will affect placement of air jets.
- System components may extend beyond the perimeter of deck.
- Please measure tub **on-site** before building tub decking.
- Advise MTI when planning to use a glass enclosure. Relocation of controls may be necessary.
- Suction and control locations may vary.

### ELECTRICAL COMPONENTS & SPECIFICATIONS

Hydrotherapy Package	Components Included	GFCI / 110V
Standard Whirlpool	2-bhp pump	1-15 amp
Stream Bath	1/2-bhp	1-15 amp
Microbubbles	Microbubbles pump	1-15 amp
Ultra Whirlpool	2-bhp pump, inline heater, ozone	2-15 amp
Air Massage	heated blower	1-15 amp
Air Massage Elite	heated blower, chromatherapy	1-15 amp
Air Massage w/ Stream Bath	1/2-bhp pump, heated blower	1-15 amp
Air Massage Elite w/ Stream Bath	1/2-bhp pump, heated blower, chromatherapy	1-15 amp

Hydrotherapy Package	Components Included	GFCI / 110V
Microbubbles with Air	Microbubbles pump, heated blower	1-20 amp
Microbubbles with Air Elite	Microbubbles pump, heated blower, chromatherapy	2-15 amp
Air with Whirlpool	2-bhp pump, heated blower	2-15 amp
Air with Ultra Whirlpool	2-bhp pump, inline heater, heated blower, ozone	2-20 amp
Air Elite with Whirlpool	2-bhp pump, heated blower, chromatherapy	2-15 amp
Air Elite with Ultra Whirlpool	2-bhp pump, inline heater, heated blower, chromatherapy, ozone	2-20 amp

See the Installation & Operation Manual for more details.  
 MTI's Customer Service Monday-Friday 8am-6pm EST  
 800-783-8827 or service@mtibaths.com

- Before discarding tub crate, check for accessories that may be packaged inside.
- All product measurements are ±1/2".
- Specifications and configurations are subject to change without notice.
- Measurements herein supersede all others published prior to publication date below.

