

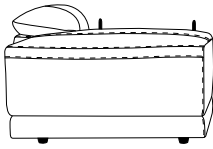

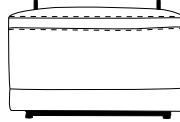
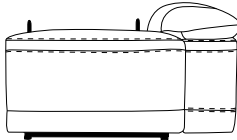
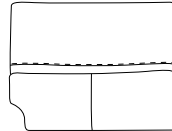
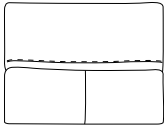
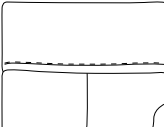

ASSEMBLY INSTRUCTIONS

SKU # 2207SC11

PARTS LIST

A	BRANFORD LAF SEAT 220711732				<p>Before Beginning</p> <p>1 - Carefully unpack and position the item on a clean, non-marring surface to assemble.</p> <p>2 - Read this Assembly Instructions from beginning to end before starting to assemble.</p> <p>3 - Take an inventory of the required parts to ensure all are available.</p> <p>4 - To prevent accidental choking hazards, keep all packing materials away from small children.</p> <p>5 - Only tighten hardware until ALL hardware are fully engaged on their locations. Overtighten bolts will damage the bolt threads.</p> <p>6 - Use only factory provided hardware to assemble. Unapproved hardware can damage product or jeopardize the structural integrity of the product.</p> <p>7 - The use of power tool to assemble is not recommended due to high risk of over-torque, which can damage the product.</p>
B	BRANFORD ARMLESS SEAT 220711529				
C	BRANFORD RAF SEAT 220711329				
D	BRANFORD LAF BACKREST 220711732				
E	BRANFORD ARMLESS BACKREST 220711529				
F	BRANFORD RAF BACKREST 220711329				
Z	HARDWARE	<p>Z1</p>  <p>2160MM X1</p>	<p>Z2</p>  <p>300MM X1</p>	<p>Z3</p>  <p>1800MM X1</p>	

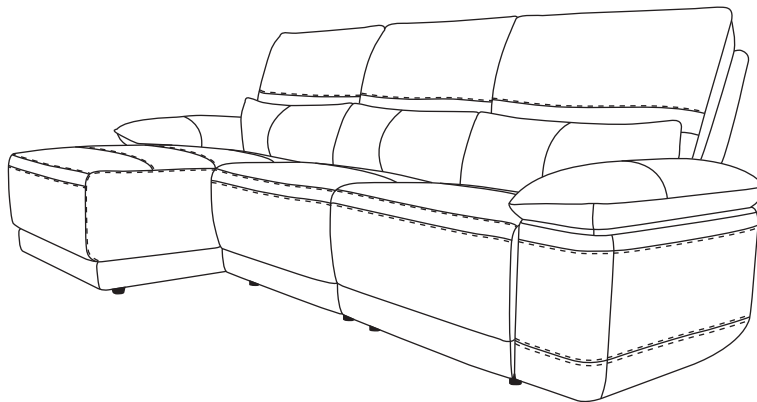

ASSEMBLY REQUIRES
TWO PEOPLE



15-MINUTE
ASSEMBLY TIME



KEEP INSTRUCTIONS
FOR FUTURE USE

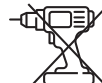

ASSEMBLY INSTRUCTIONS

SKU # 2207SC11

1

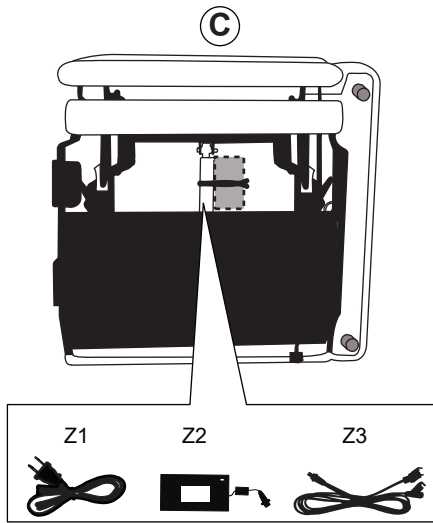

2

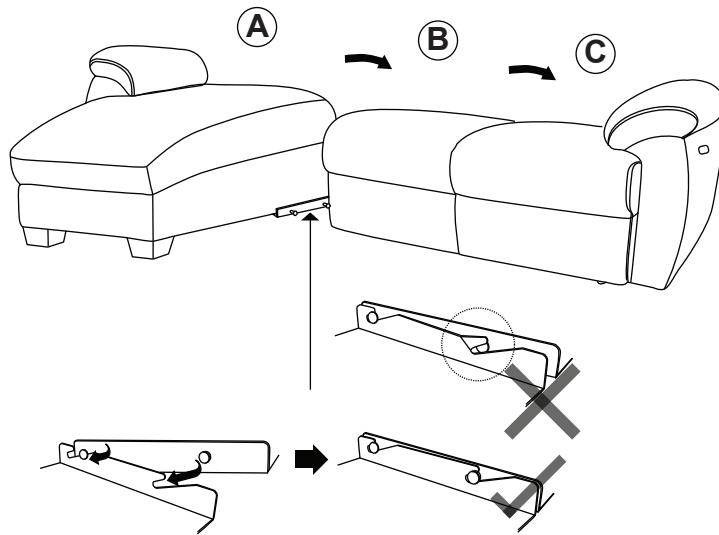

3

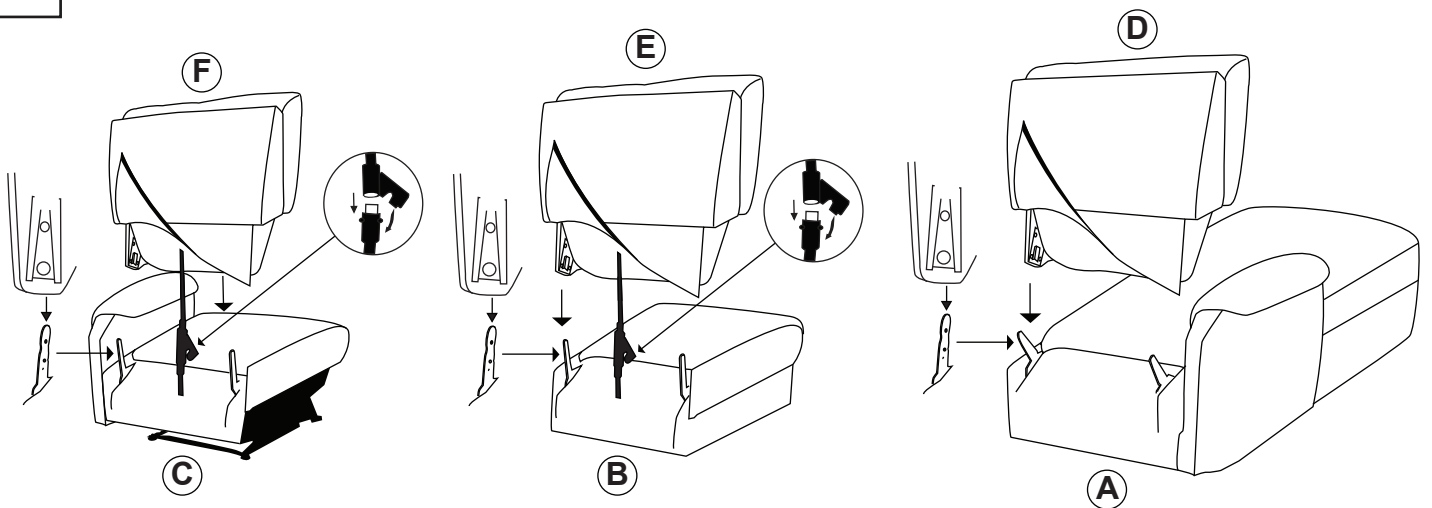

ASSEMBLY INSTRUCTIONS
SKU # 2207SC11

4

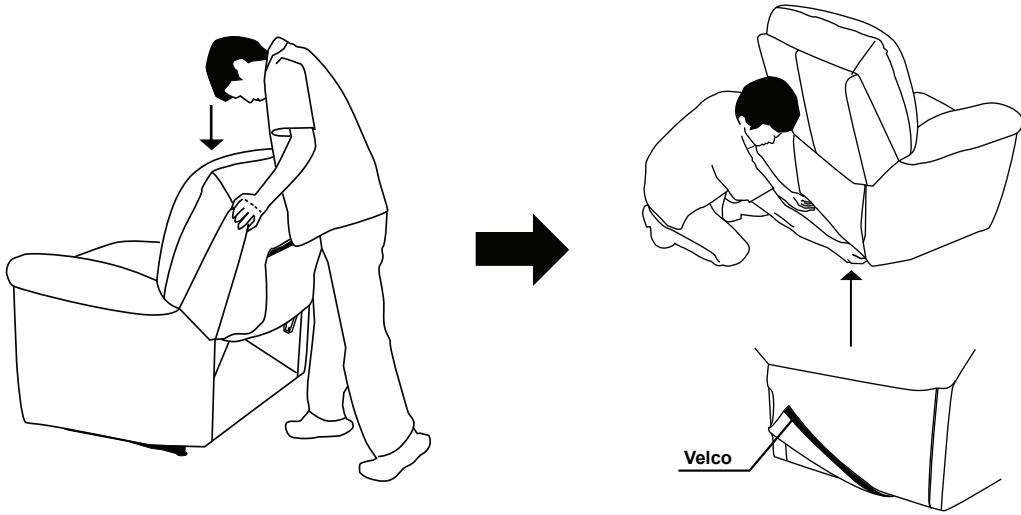

5

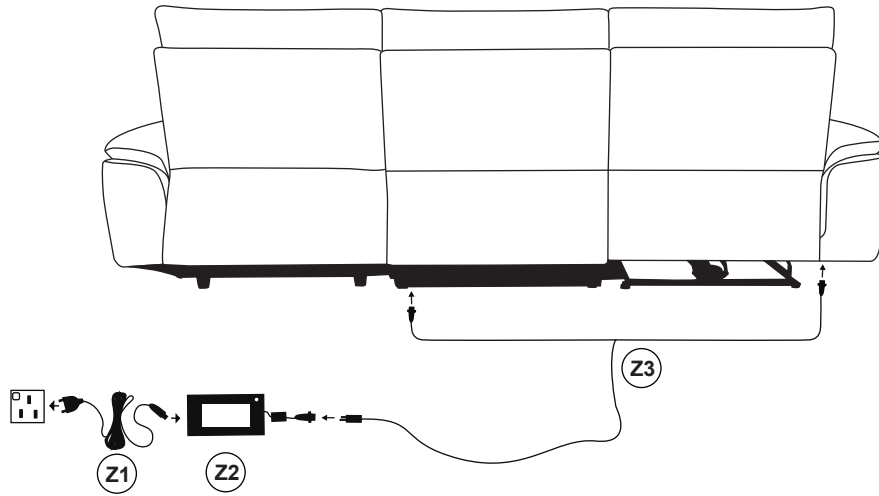

6

SKU#220711329

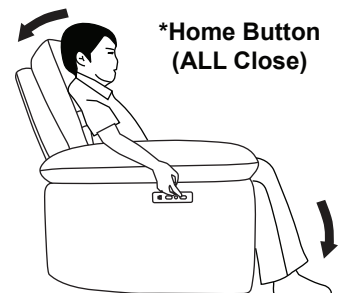
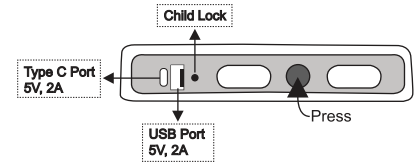
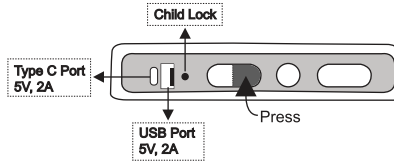
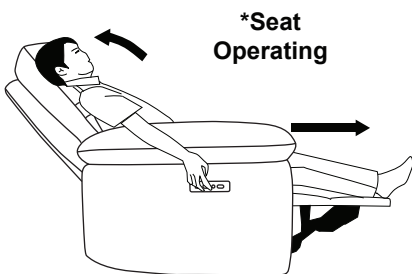
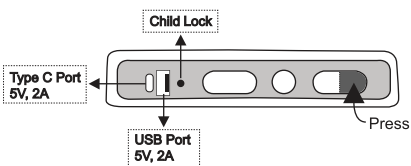

ASSEMBLY INSTRUCTIONS
SKU # 2207SC11

7

SKU#220711529

