

PL> INSTRUKCJA MONTAŻU
D >MONTAGEANLEITUNG
GB>ASSEMBLY INSTRUCTIONS
NL>MONTAGE HANDLEIDING
F >MODEL D'EMPLOI

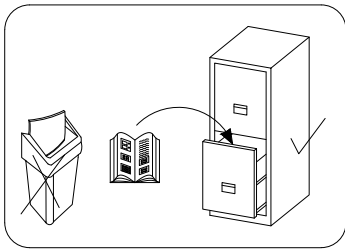

Czas montażu
 Montagezeit
 Time to assemble
 Installatie
 Time installation

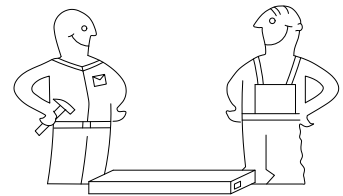
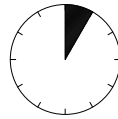

1 godz.
 1 zeit
 1 hours
 1 hours.
 1 time.

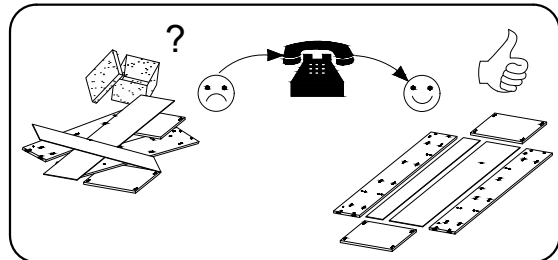
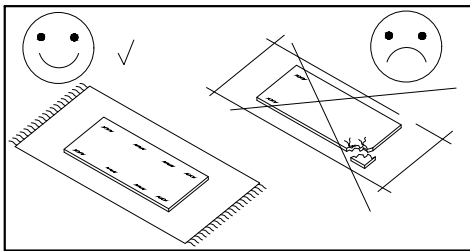
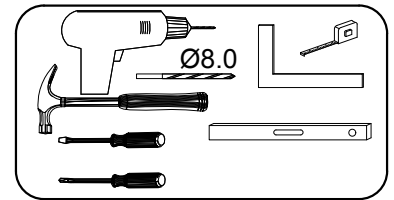

Uwaga / Achtung / Caution / Opmerking / Attention

PL>wskazowka dotyczaca pielegnacji !prosze czyscic tylko suchą lub lekko wilgotna szmatka do kurzu nie używac żadnych srodków szorstkich !

szanowny kliencie, jeśli podczas montażu stwierdzisz uszkodzenie lub brzęczęści, proszę podaj jej kod alfanumeryczny lub zaznacz ją na instrukcji montażu i prześlij wraz z protokołem reklamacyjnym

Do zamocowania mebla do ściany należy zastosować kołek odpowiedni do rodzaju ściany, w przypadku problemów wezwać osobę wykwalifikowaną.

D >pflegehinweis! bitte nur mit einem staubtuch oder einem feuchten lappen reinigen. rauhen objekte erwenden.

sehr geehrter kunde, sollte ein teil fehlen oder beschadigt sein, kreuzen sie dies bitte deutlich auf der montageanleitung an und schicken sie die montageanleitung mit ein.

um das möbelstück an der wand zu befestigen, brauchen sie einen an die wand angepassten pflock; welcher nicht standardmäßig geliefert wird. falls probleme auftauchen, eine qualifizierte person herbeirufen.

GB >treatment advice! please clean only with a dry or lightly humid duster. do not use any rough objects.

Dear customer, should there be any piece missing or damaged, kindly mark this piece clearly on the attached assembly instructions and return them to us.

for attaching the piece of furniture to the wall, you need a stake suitable for the type of wall; a stake will not be delivered. in case of problems, call a qualified person.

NL >schoonmaak tip! maak het badkamermeubel schoon met een droge of licht vochtige doek. gebruik hiervoor geen schurende middelen.!











beste klant, mocht er een onderdeel ontbreken of beschadigd zijn, vermeld dan graag het nummer van het onderdeel op deze beschrijving en stuur deze terug naar ons.

Voordat u het meubel aan de muur bevestigd: Let op dat u de juiste plug gebruikt, geschikt voor uw muur type. Twijfel je over welke plug je het beste kunt gebruiken neem dat contact op met de vakhandel.

FR >conseil d'entretien! nettoyer seulement avec un chiffon poussière ou un chiffon humide, ne pas utiliser d'objet rugueux sous peine de rayure

cher client, si une pièce est manquante ou endommagée, marquer ça bien sur le mode d'emploi est l'envoyer avec le procès-verbal de la réclamation

for attaching the piece of furniture to the wall, you need a stake suitable for the type of wall; a stake will not be delivered. in case of problems, call a qualified person.

7.0x50  O 48	 X1 48	Ø8.0x50  KR 4	3.0x20  P1 8	 B 1	 B1 1	 Z1 4	 J 4	 W 1	3.5x13  P2 1
--	--	--	---	--	---	---	---	--	---

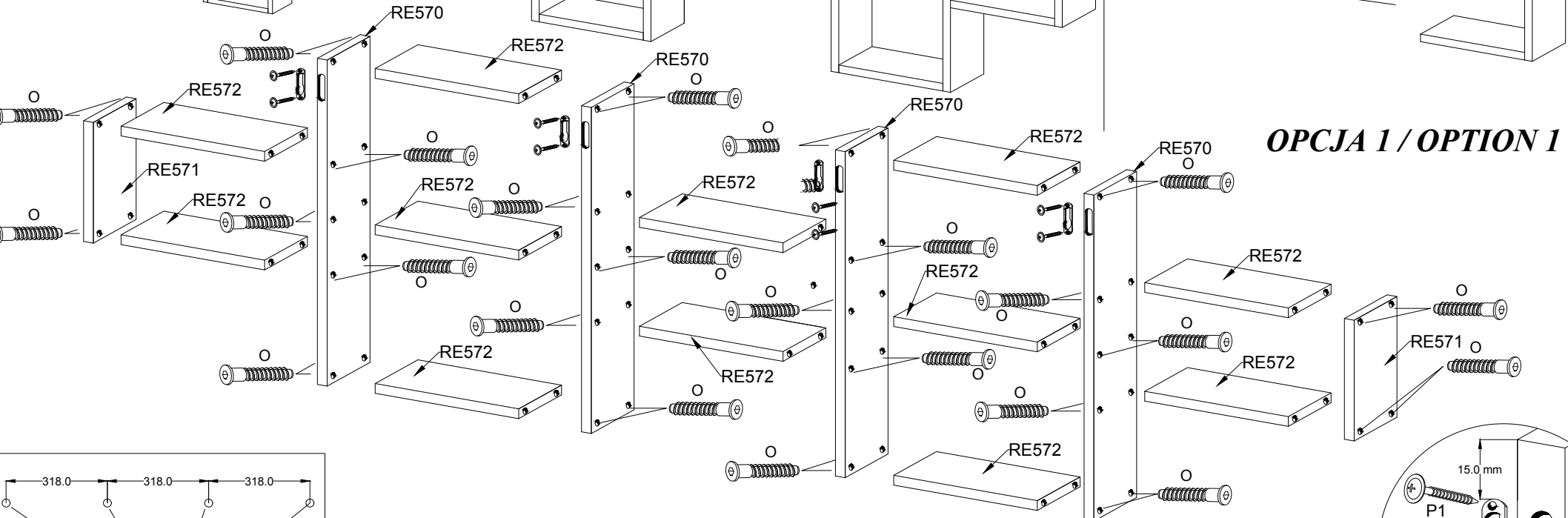
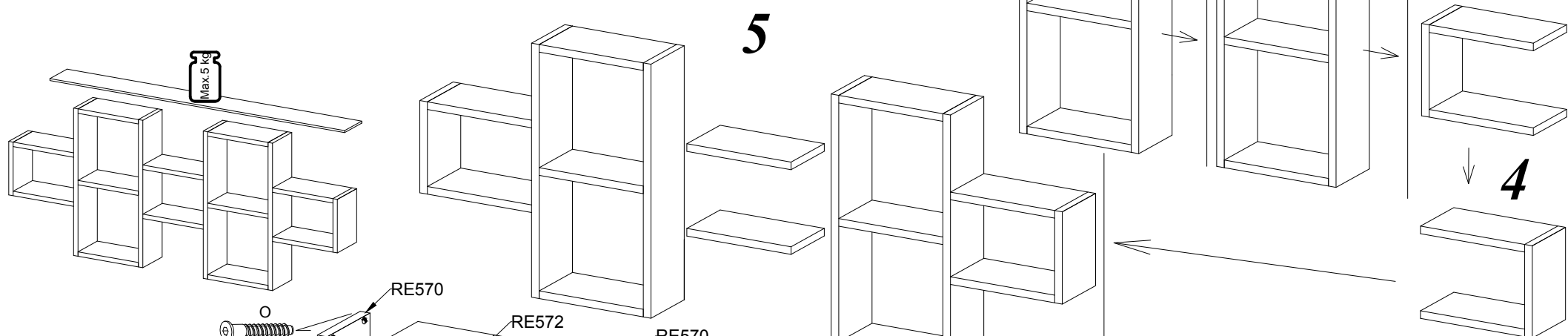

OPCJA 1 / OPTION 1

