











**Note: Before completing the installation,
do not tighten the screws.**

A		M8x70mm	M5870	x4
B				x4
C		M6x45mm	M4645	x10
D		M6x12mm	M4612	x8
E		Φ8		x14
F		M6		x4
G		M6x35mm	M4635	x4
H		Φ7		x4
I			Alkey4	x1
J			Alkey5	x1
K				x1



STEP 1

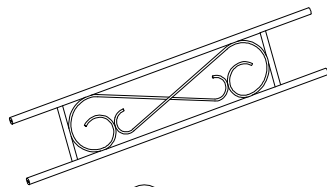
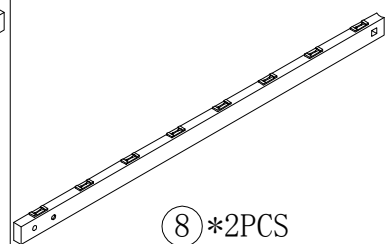
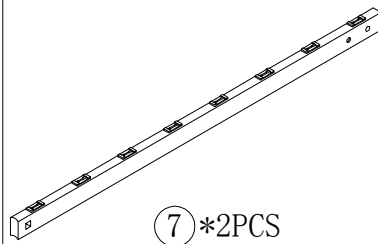
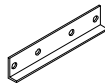
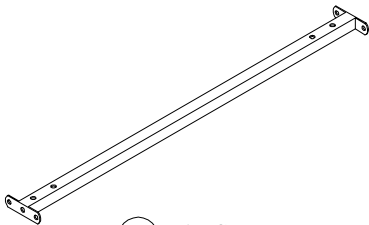
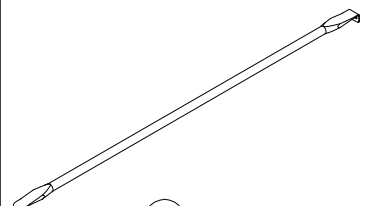
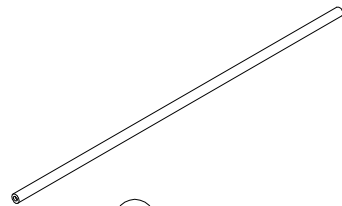
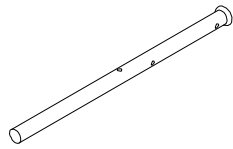
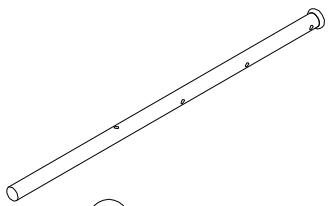
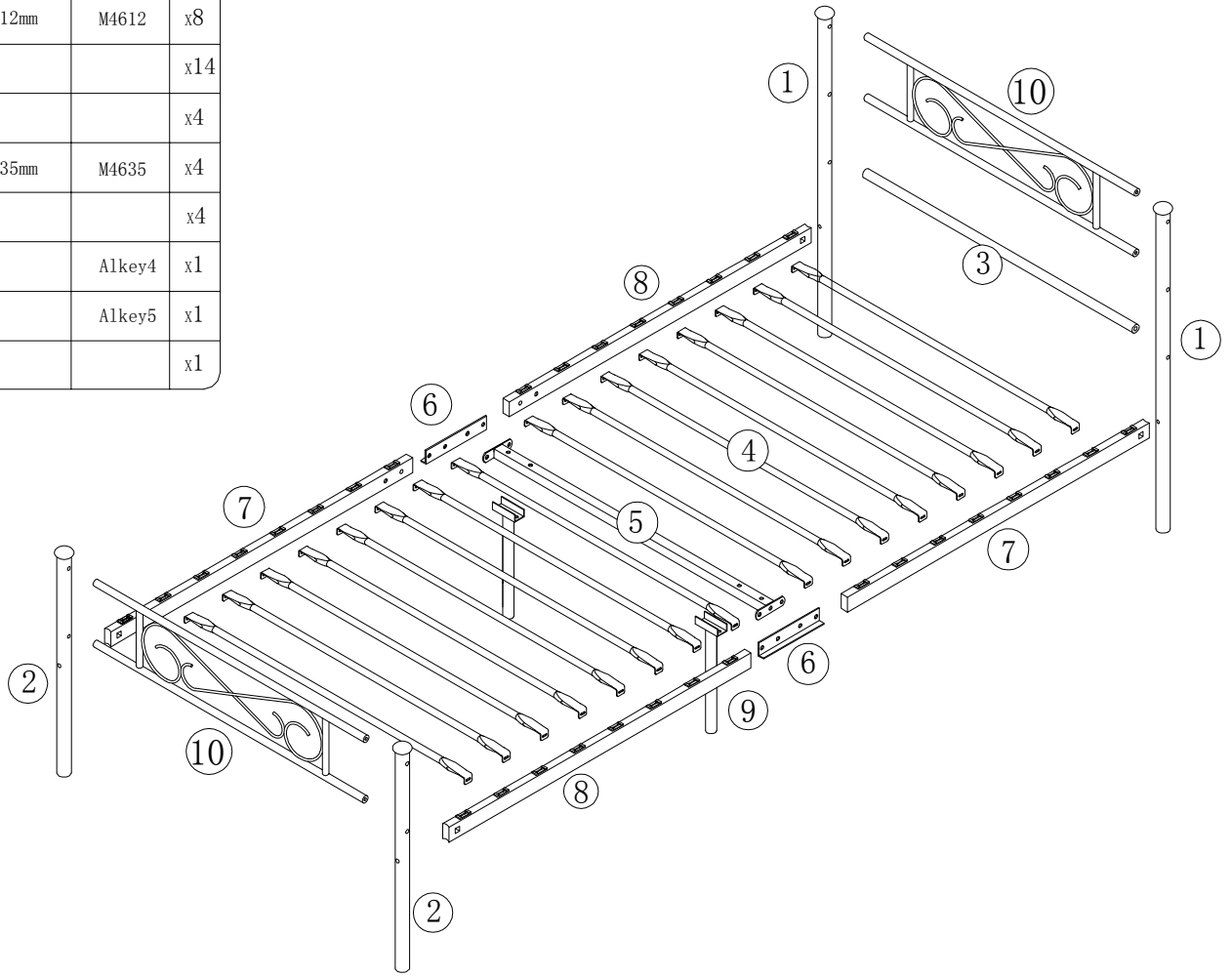
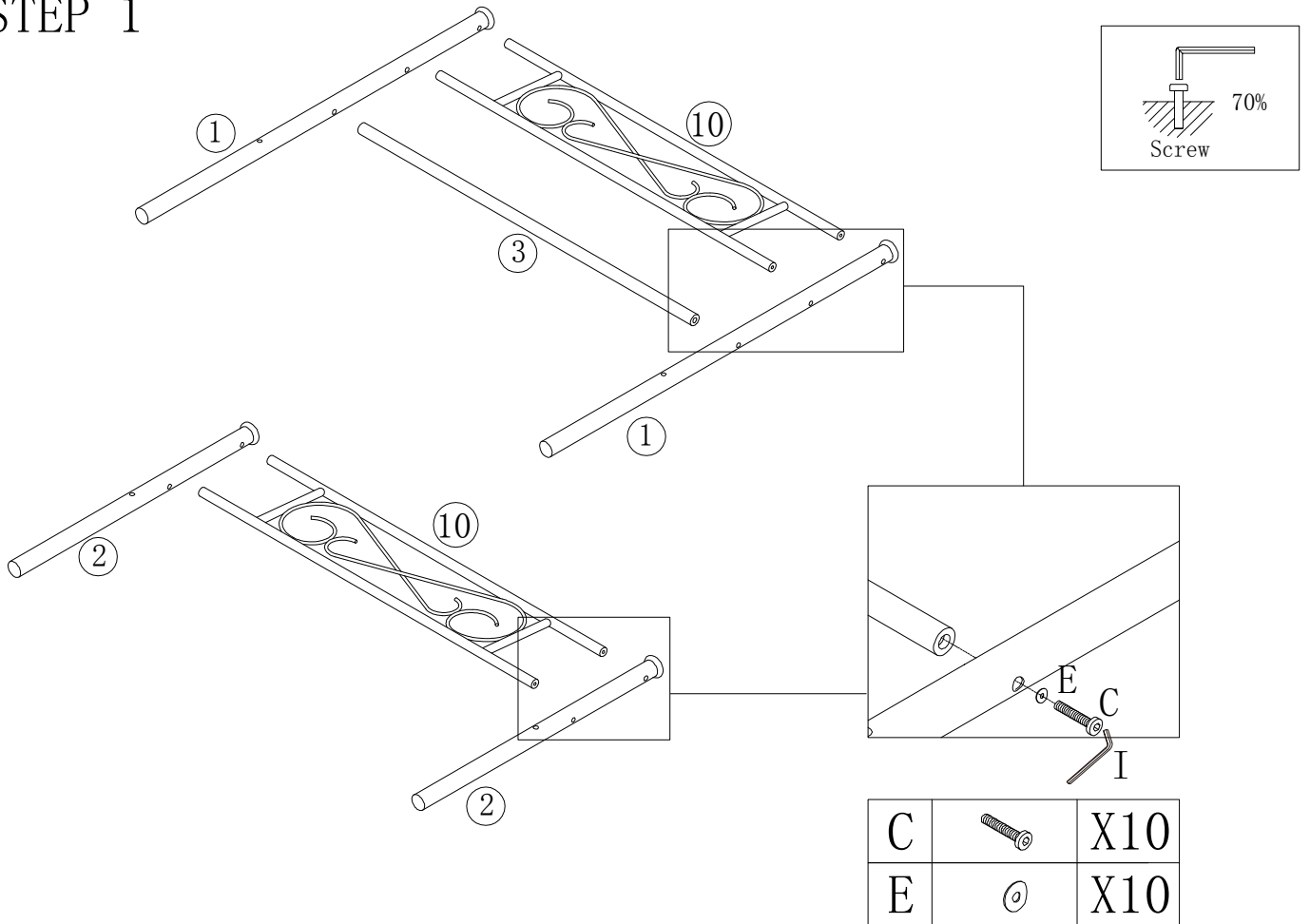

STEP 2

Please separate the parts 7 and 8 before beginning the assembly.

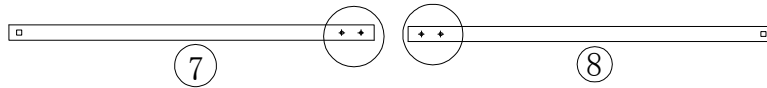

Tighten the screws at both ends only.

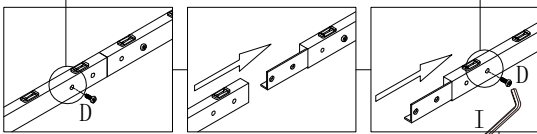

D X2

The small piece #6 goes inside the two longer piece 7 and 8.

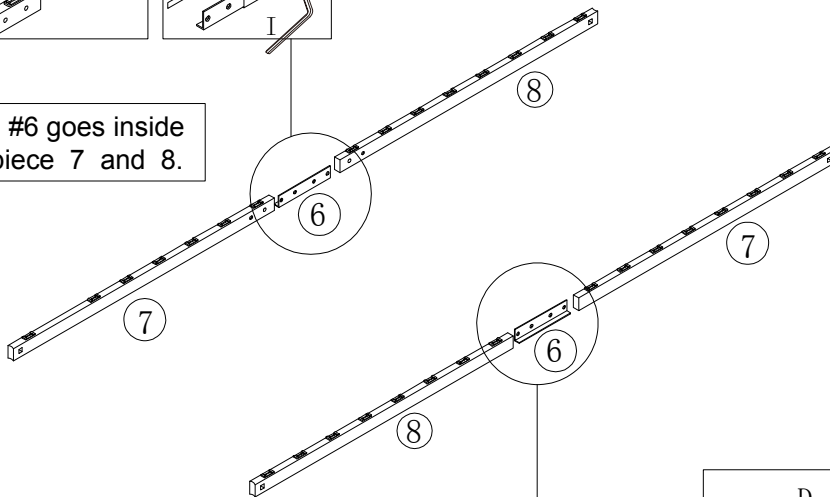

Attention: The middle two holes should not be screwed on

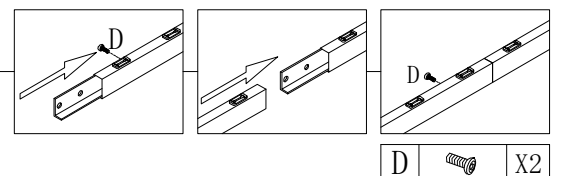
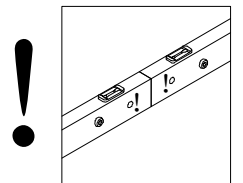

D X2

STEP 3

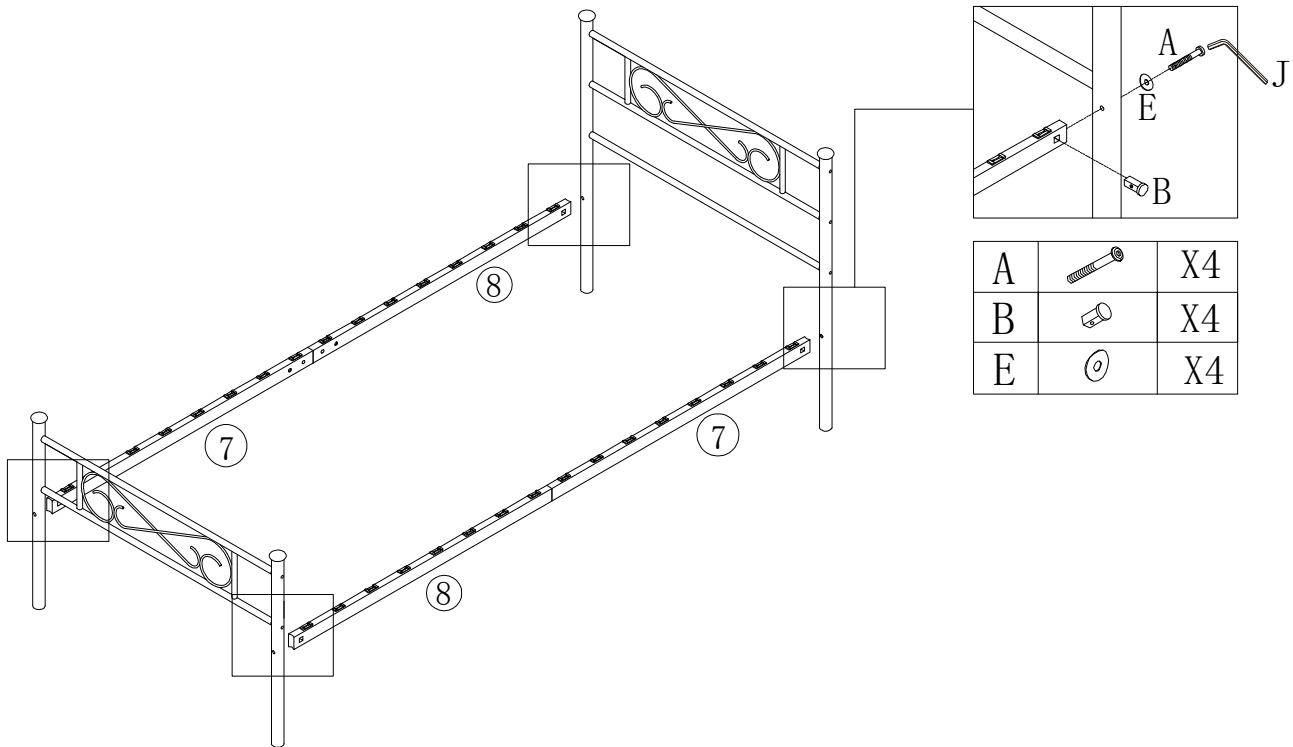
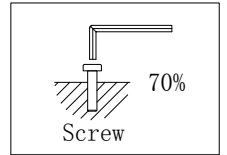

A		X4
B		X4
E		X4

STEP 4

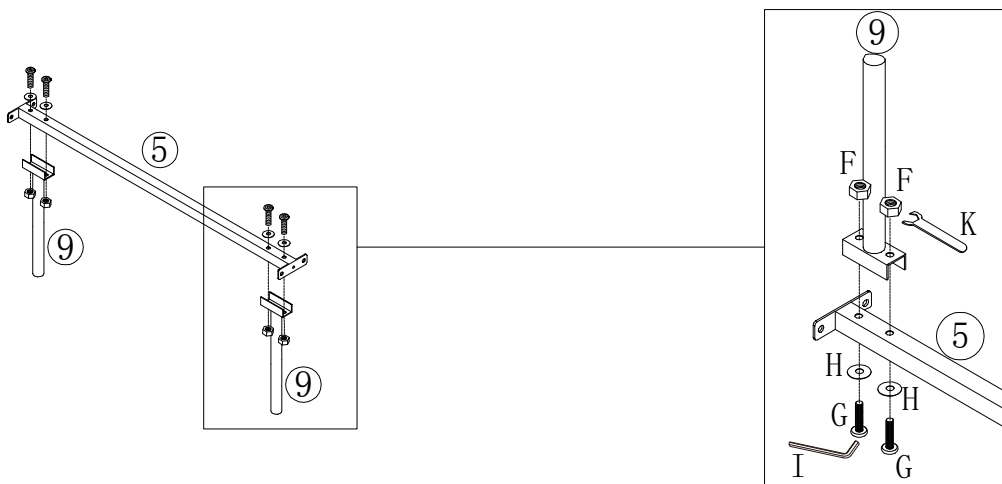
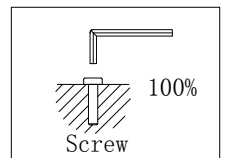

G		X4
H		X4
F		X4

STEP 5

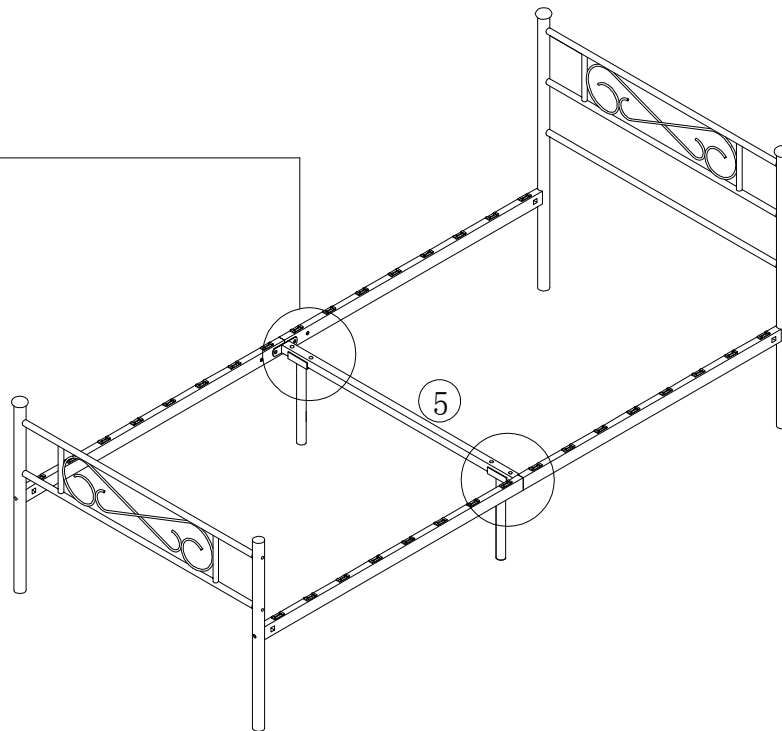
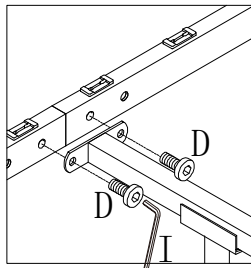
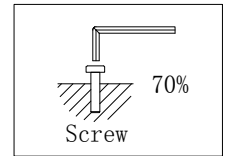

STEP 6

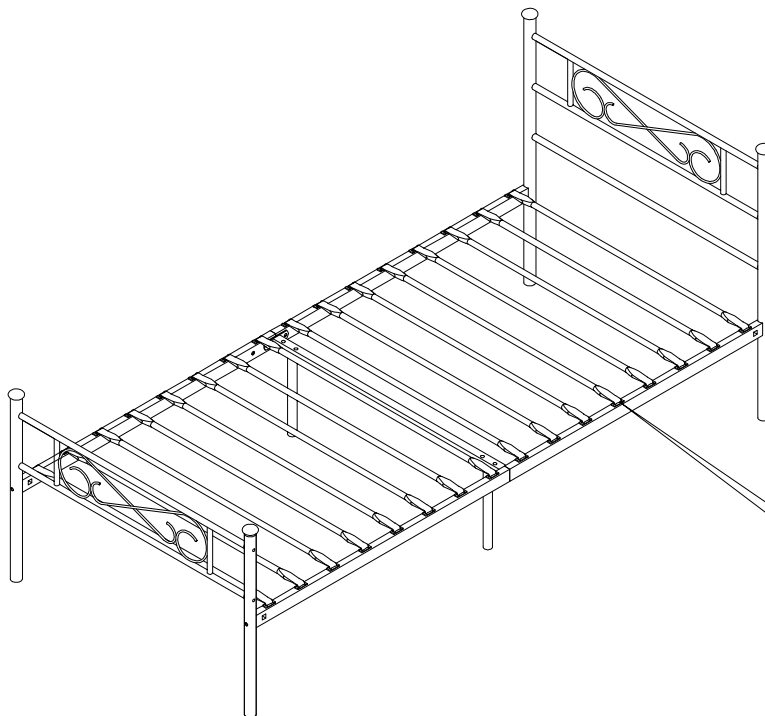

Both sides need to be symmetrical before installation

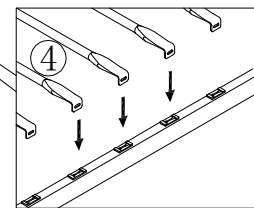

All screws shall be tightened after the bed plate is installed