

Bed Frame

## CAUTIONS!

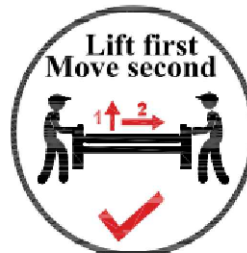

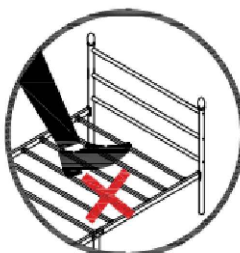
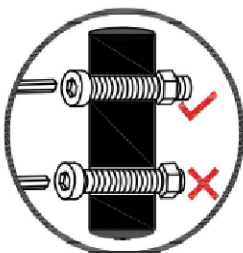

## Tips!

Check all the components & screws before assembly. Do not install in case part is missing, contact us to get. Send email with your question. We will resend within 24 hours.

## Return Policy

We believe you will absolutely love your new item. But if for some reason you want to return, please contact us directly before you decide to return your product. Our customer service organization can answer most concerns and assist you with any questions you may have about your new item, please email us first. The item must be returned within 30 days of delivery for a full refund. The item must be returned in good condition, in original box, with all original proof of purchase, parts and accessories. Send email with your question. Resend within 24 hours Issue resolved Missing parts. Trouble shooting: Send email with your question. Respond within 24 hours Issue resolved Other issues We control manufacturing

## Trouble shooting:

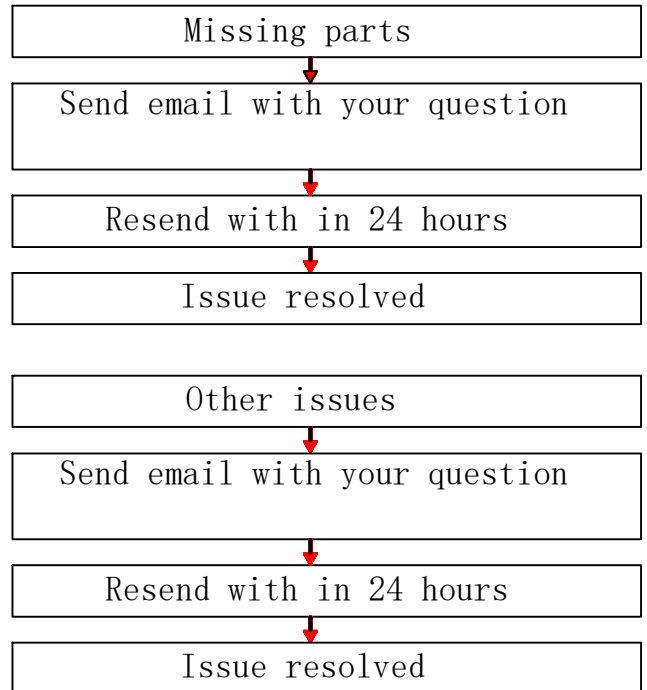

We control manufacturing and distribution ourselves, ensure the quality

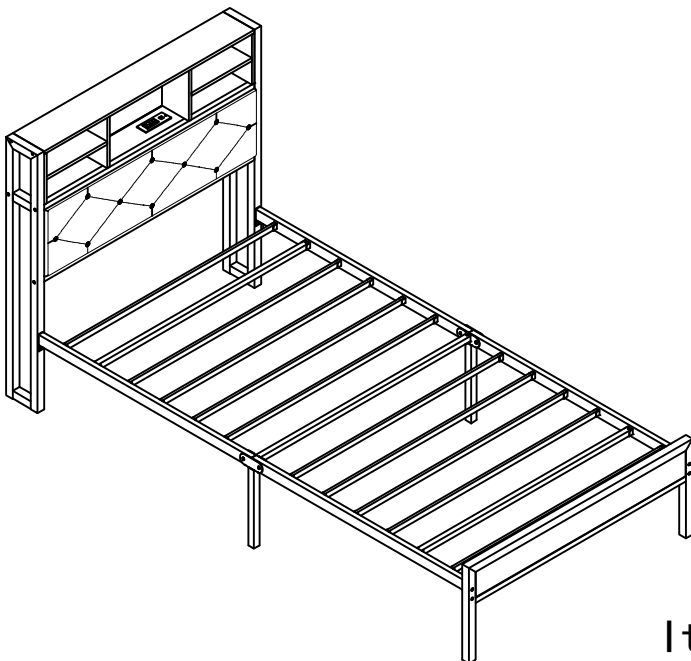





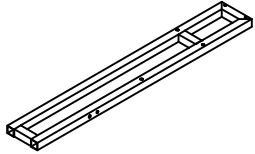
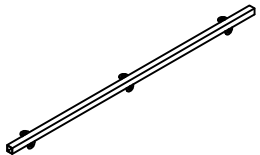
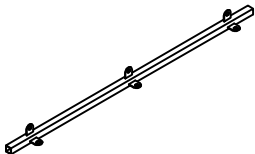
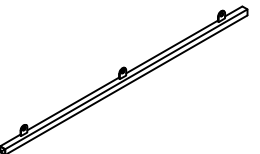
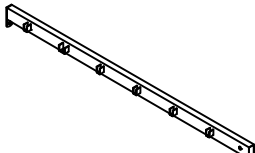
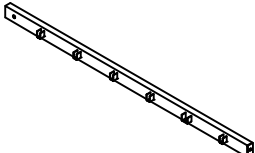
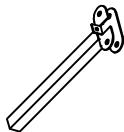
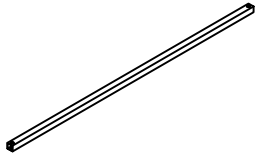
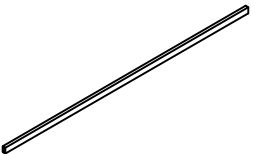
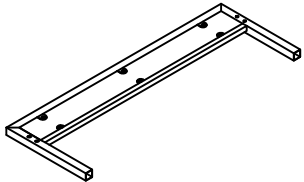
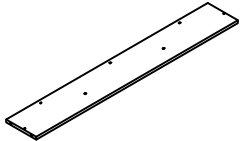
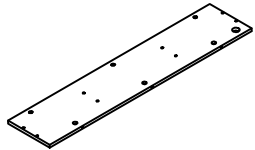
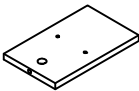
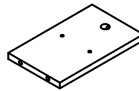

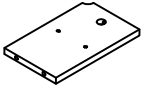
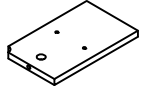
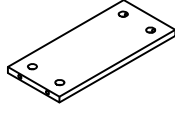
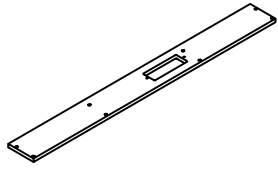
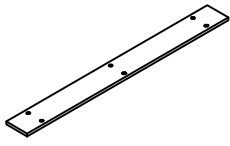
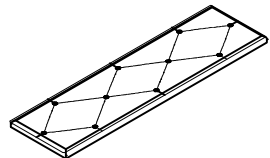

Item Description: Bed Frame

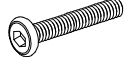
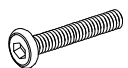

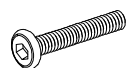

# PARTS

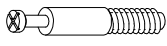
Item no. Nr. N° d'article Articolo No. Artículo No.	Reference Image Referenzbild Image de référence Immagine di riferimento Imagen de referencia	Qty. Menge Qté. Qtà Cant.	Item no. Nr. N° d'article Articolo No. Artículo No.	Reference Image Referenzbild Image de référence Immagine di riferimento Imagen de referencia	Qty. Menge Qté. Qtà Cant.
1		2PCS	2		1PC
3		1PC	4		1PC
5		2PCS	6		2PCS
7		2PCS	8		3PCS
9		10PCS	10		1PC
11		1PC	12		1PC
13		1PC	14		1PC

# PARTS

Item no. Nr. N° d'article Articolo No. Artículo No.	Reference Image Referenzbild Image de référence Immagine di riferimento Imagen de referencia	Qty. Menge Qté. Qtà Cant.	Item no. Nr. N° d'article Articolo No. Artículo No.	Reference Image Referenzbild Image de référence Immagine di riferimento Imagen de referencia	Qty. Menge Qté. Qtà Cant.
15		1PC	16		1PC
17		2PCS	18		1PC
19		1PC	20		1PC
A	 M6*10mm	15+1 PCS	B	 M6*35mm	10+1 PCS
C	 M6*50mm	6PCS	D	 M6*15mm	6PCS
E	 M8*45mm	8PCS	F	 M6*10*5mm	4PCS
G	 M8*12*6mm	4PCS	H	 M8*Ø19*1.5mm	12PCS
I	 M6x50mm	20+2 PCS	J		15PCS

# PARTS

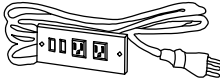
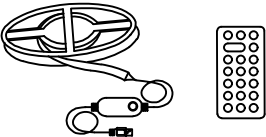
Item no. Nr. N° d'article Articolo No. Artículo No.	Reference Image Referenzbild Image de référence Immagine di riferimento Imagen de referencia	Qty. Menge Qté. Qtà Cant.	Item no. Nr. N° d'article Articolo No. Artículo No.	Reference Image Referenzbild Image de référence Immagine di riferimento Imagen de referencia	Qty. Menge Qté. Qtà Cant.
<b>K</b>		15PCS	<b>L</b>	 F4x8mm	2PCS
<b>M</b>	 M4-60mm	1PC	<b>N</b>	 10MM	1PC
<b>O</b>	 12MM	1PC	<b>P</b>		1PC
<b>Q</b>		1PC			

# EXPLODED VIEW

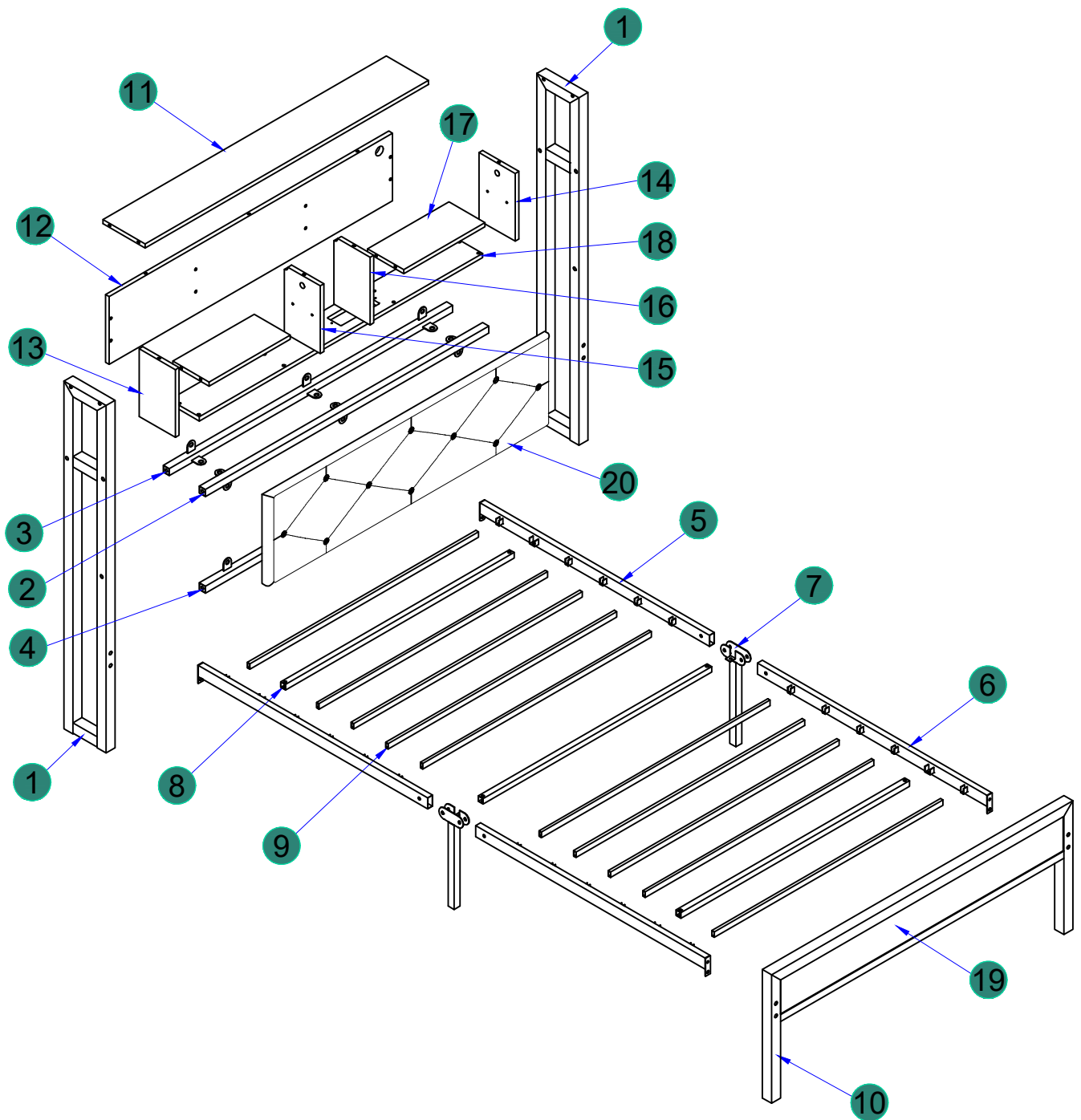

# ASSEMBLY

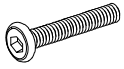

① 6PCS

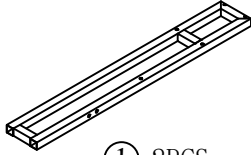

① 2PCS

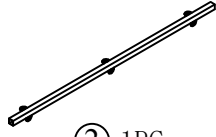

② 1PC

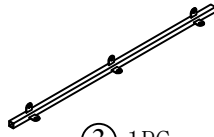

③ 1PC

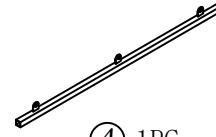

④ 1PC

## Step 1

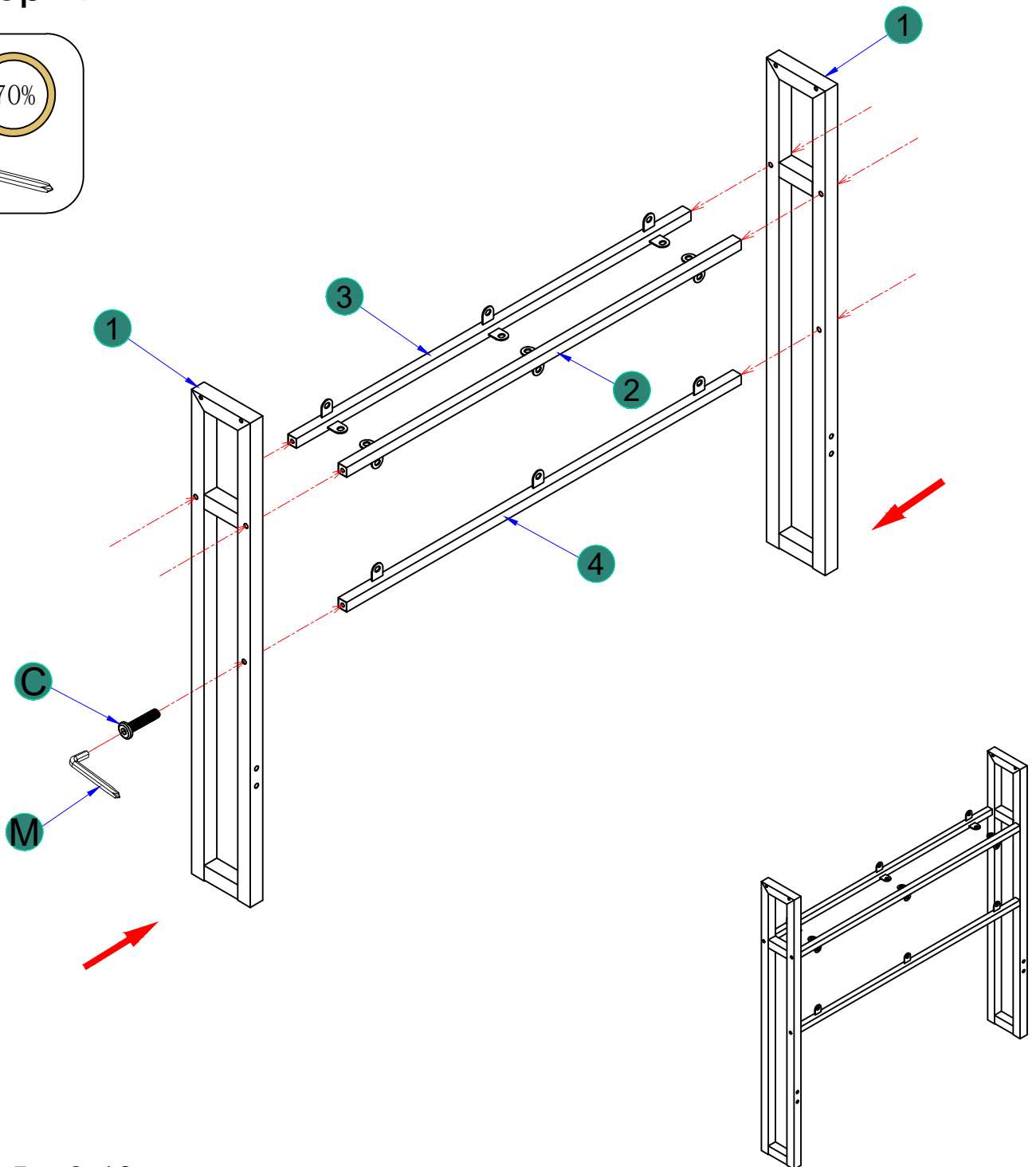
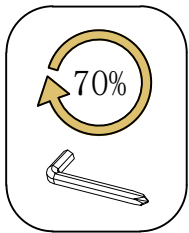

# ASSEMBLY

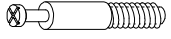

ⓐ 7PCS

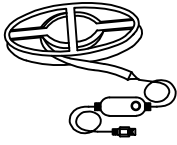

ⓑ 1PC

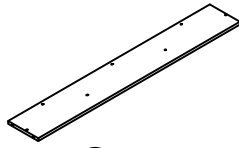

ⓒ 1PC

## Step 2

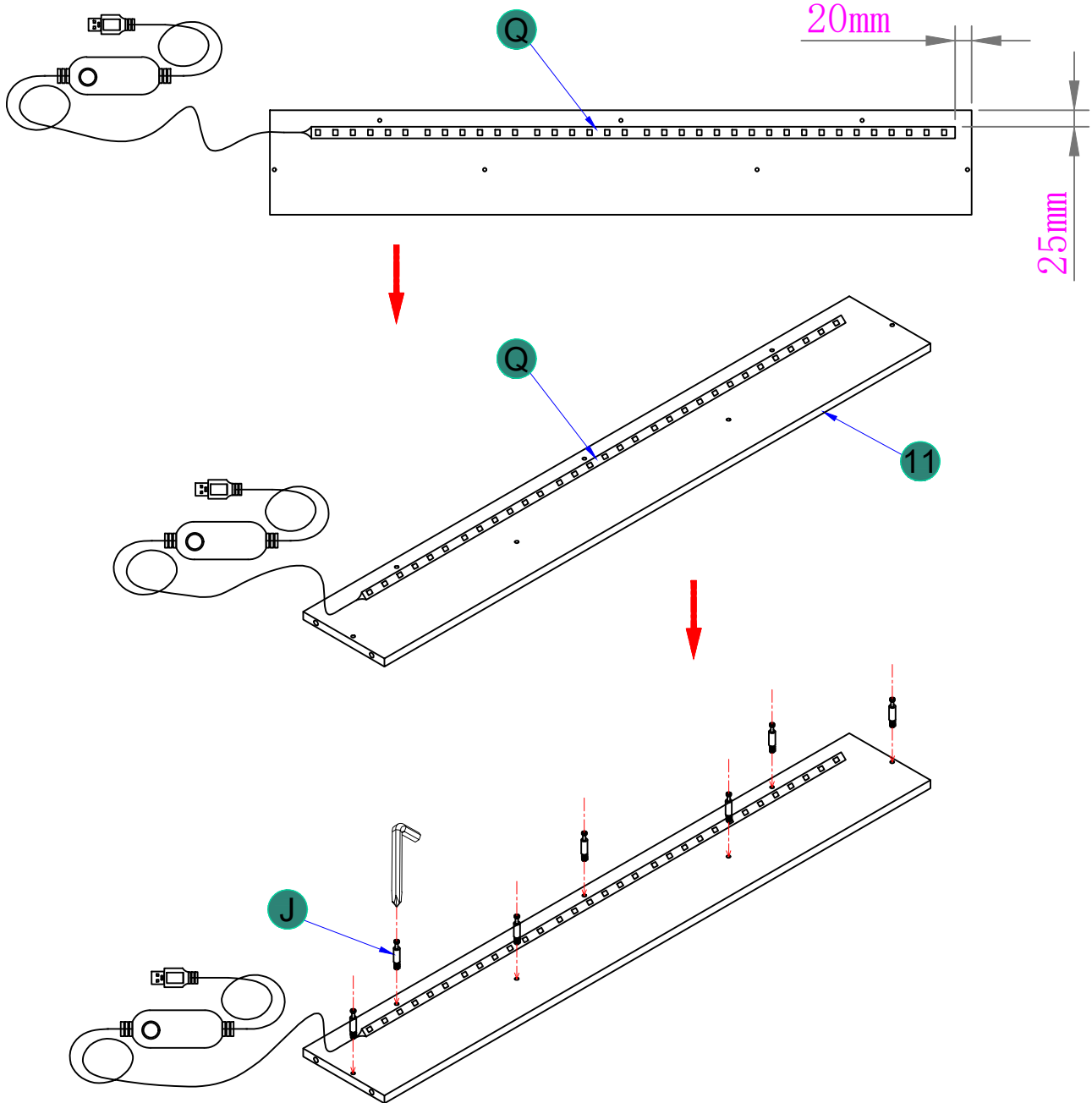

# ASSEMBLY



(K) 3PCS

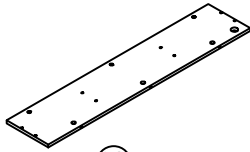

(12) 1PC

## Step 3

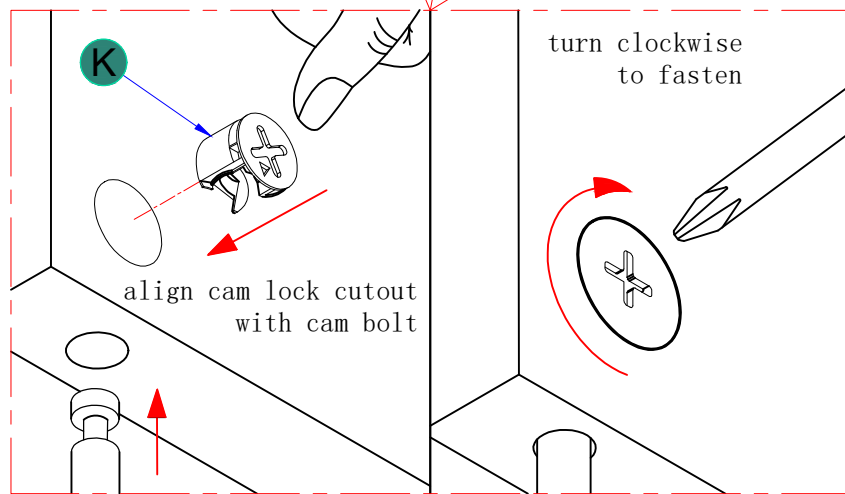
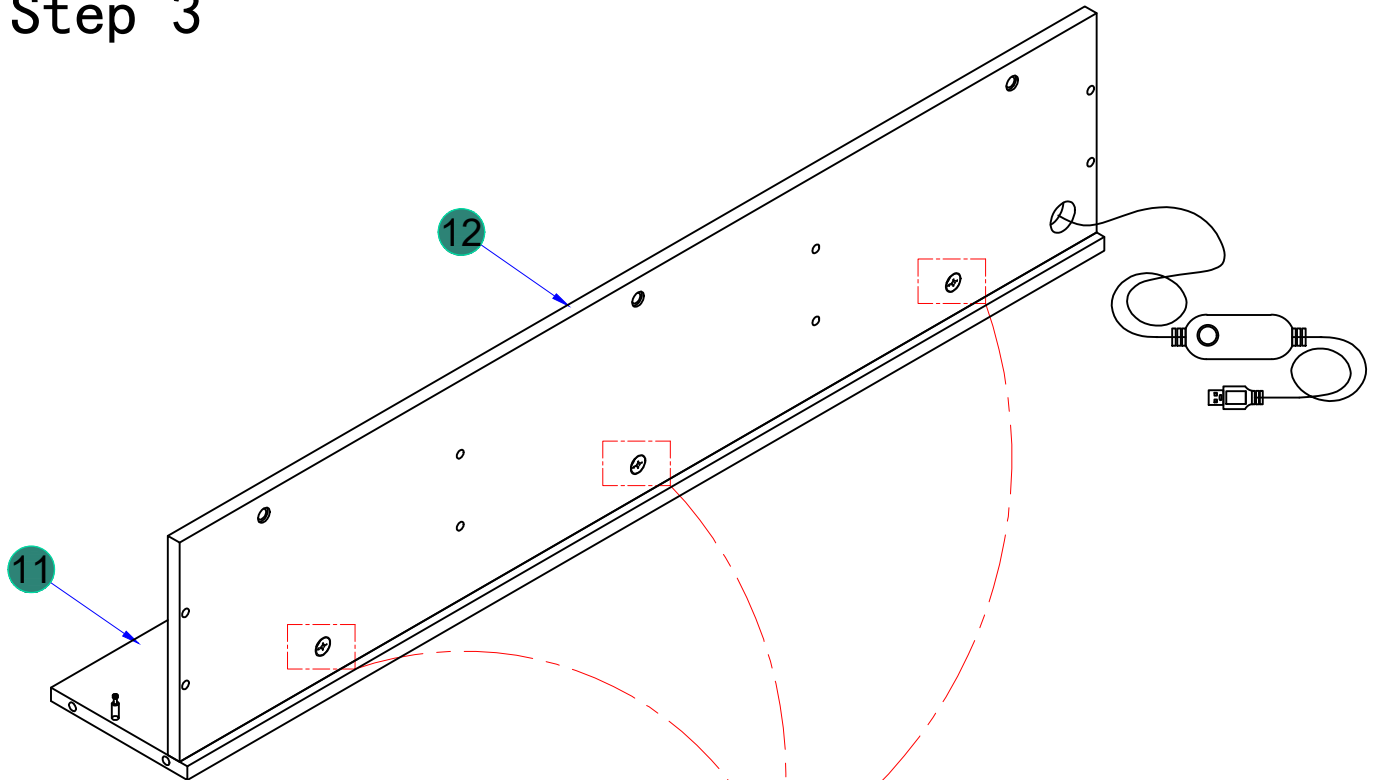

# ASSEMBLY



ⓐ 8PCS

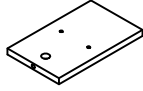

ⓑ 1PC

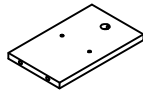

ⓒ 1PC

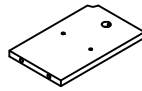

ⓓ 1PC

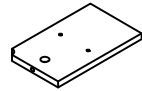

ⓔ 1PC

## Step 4

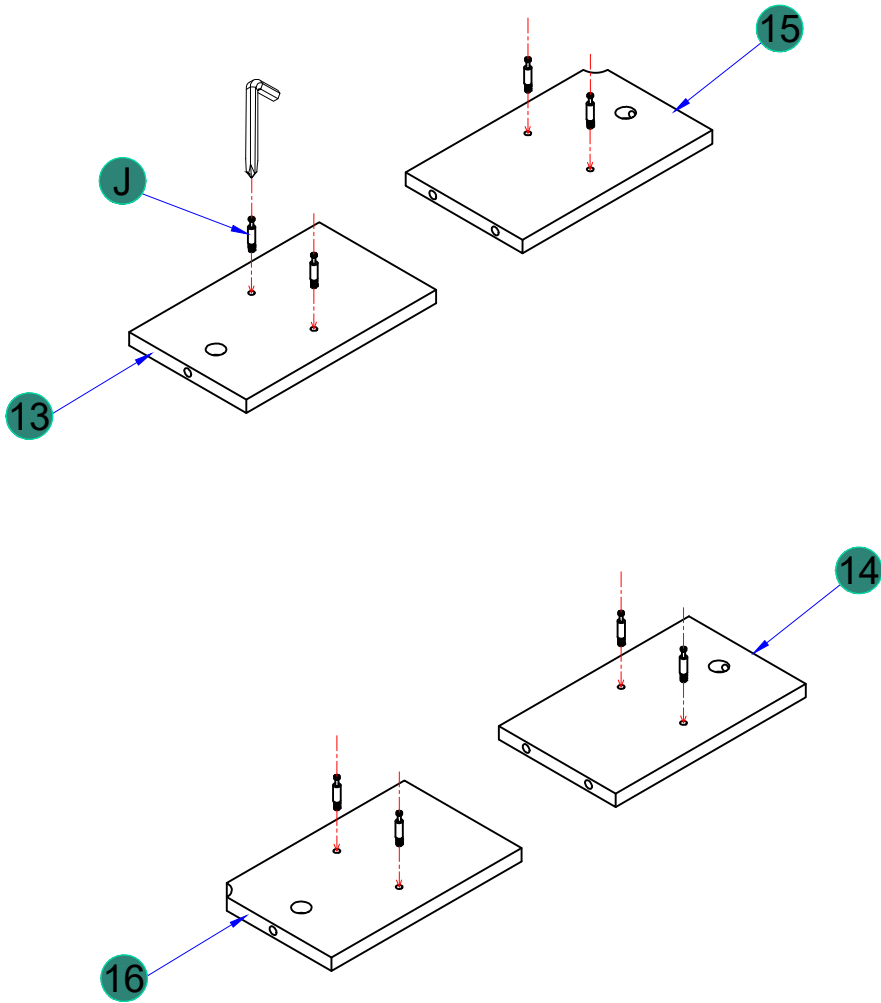

# ASSEMBLY



Ⓚ 8PCS

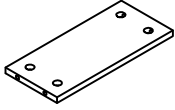

⑰ 2PCS

## Step 5

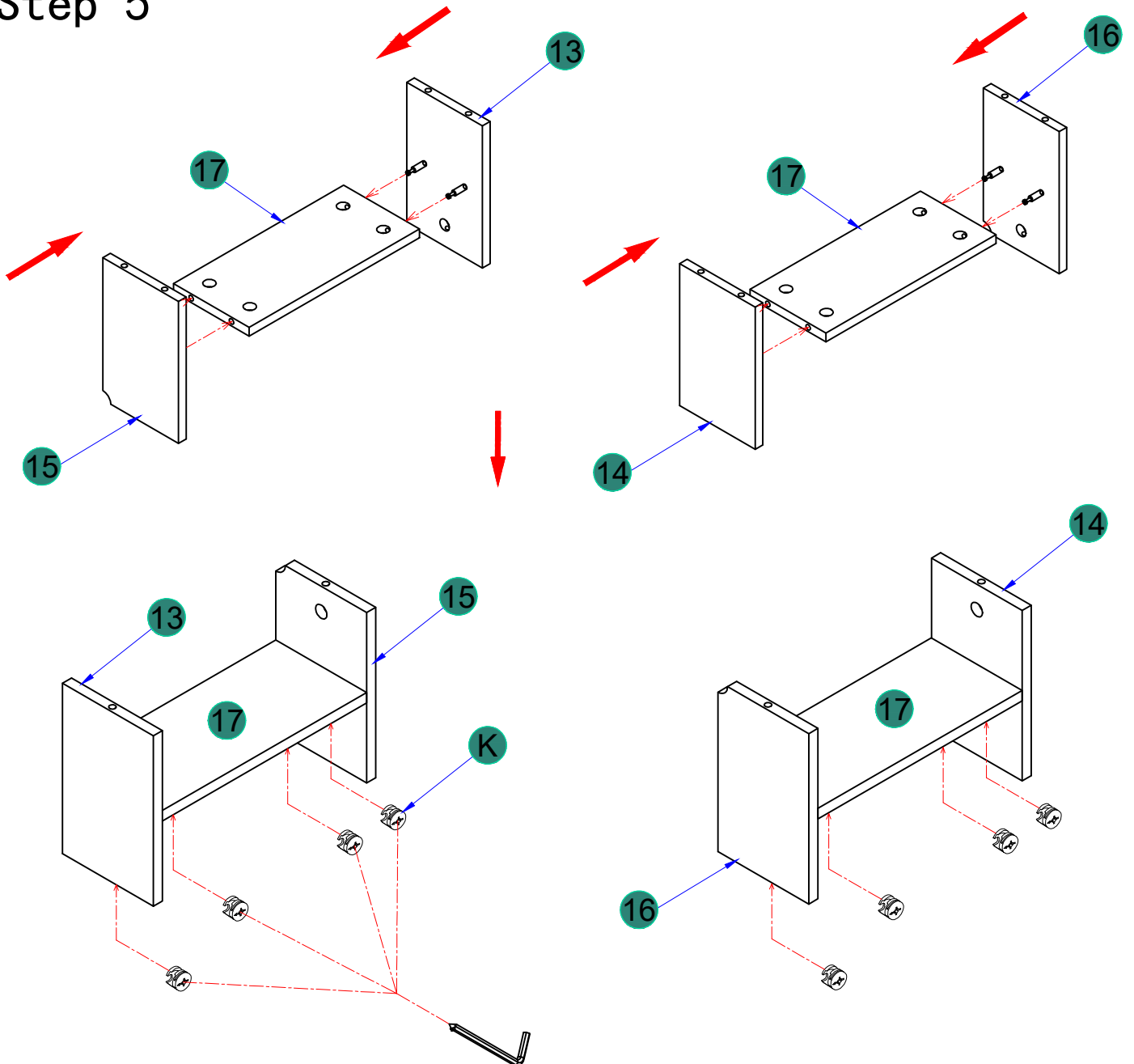

# ASSEMBLY



Ⓚ 4PCS



Ⓢ 8PCS

## Step 6

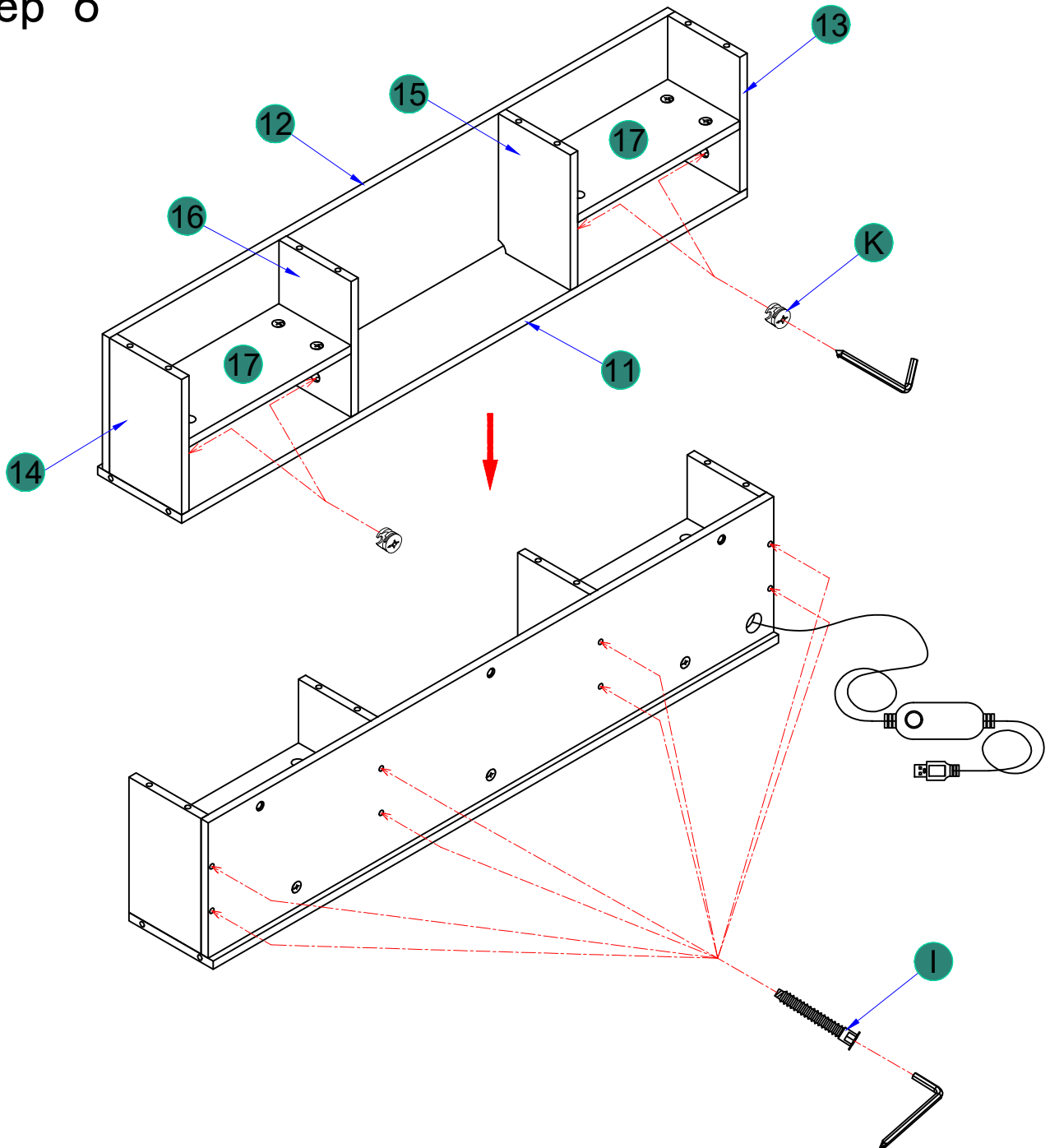

# ASSEMBLY



① 8PCS

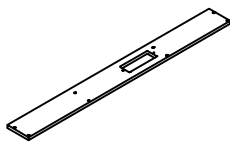

⑱ 1PC

## Step 7

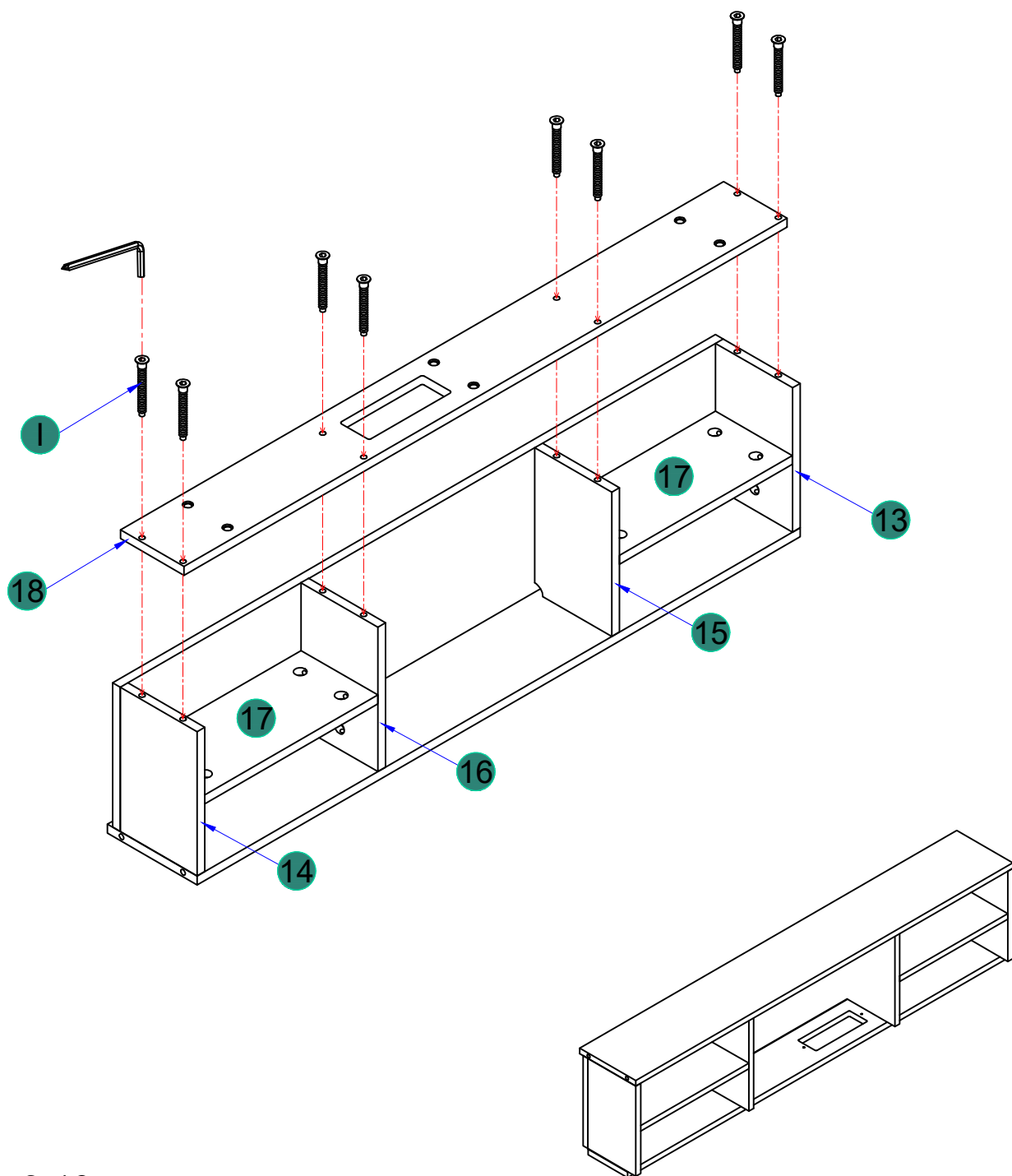

# ASSEMBLY



Ⓐ 3PCS



Ⓘ 4PCS

## Step 8

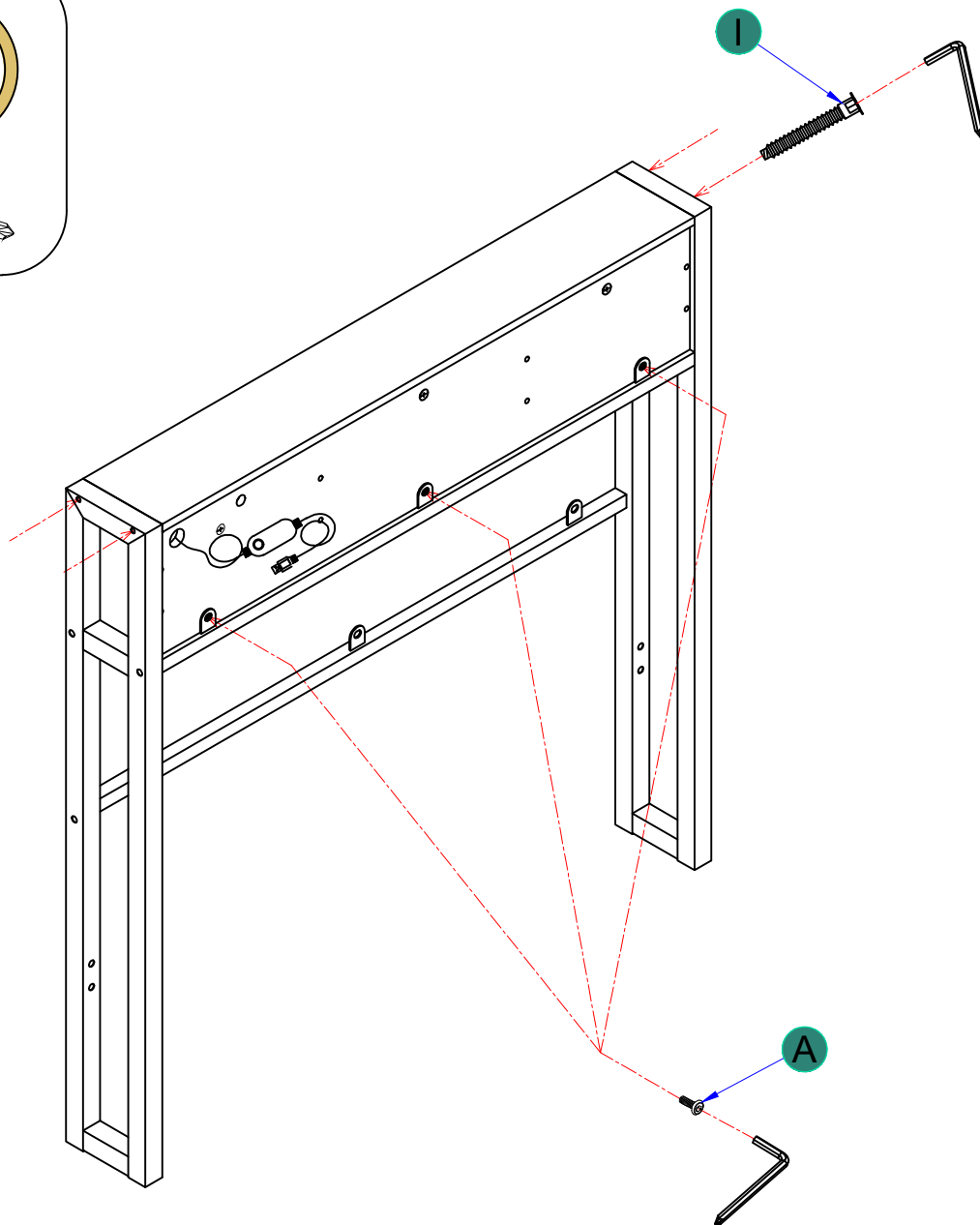
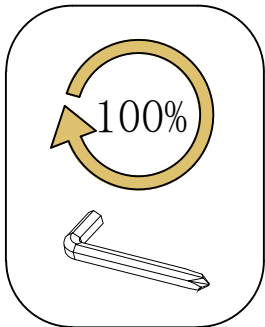

# ASSEMBLY



Ⓐ 6PCS



Ⓘ 2PCS

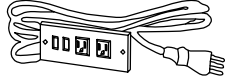

Ⓟ 1PC

## Step 9

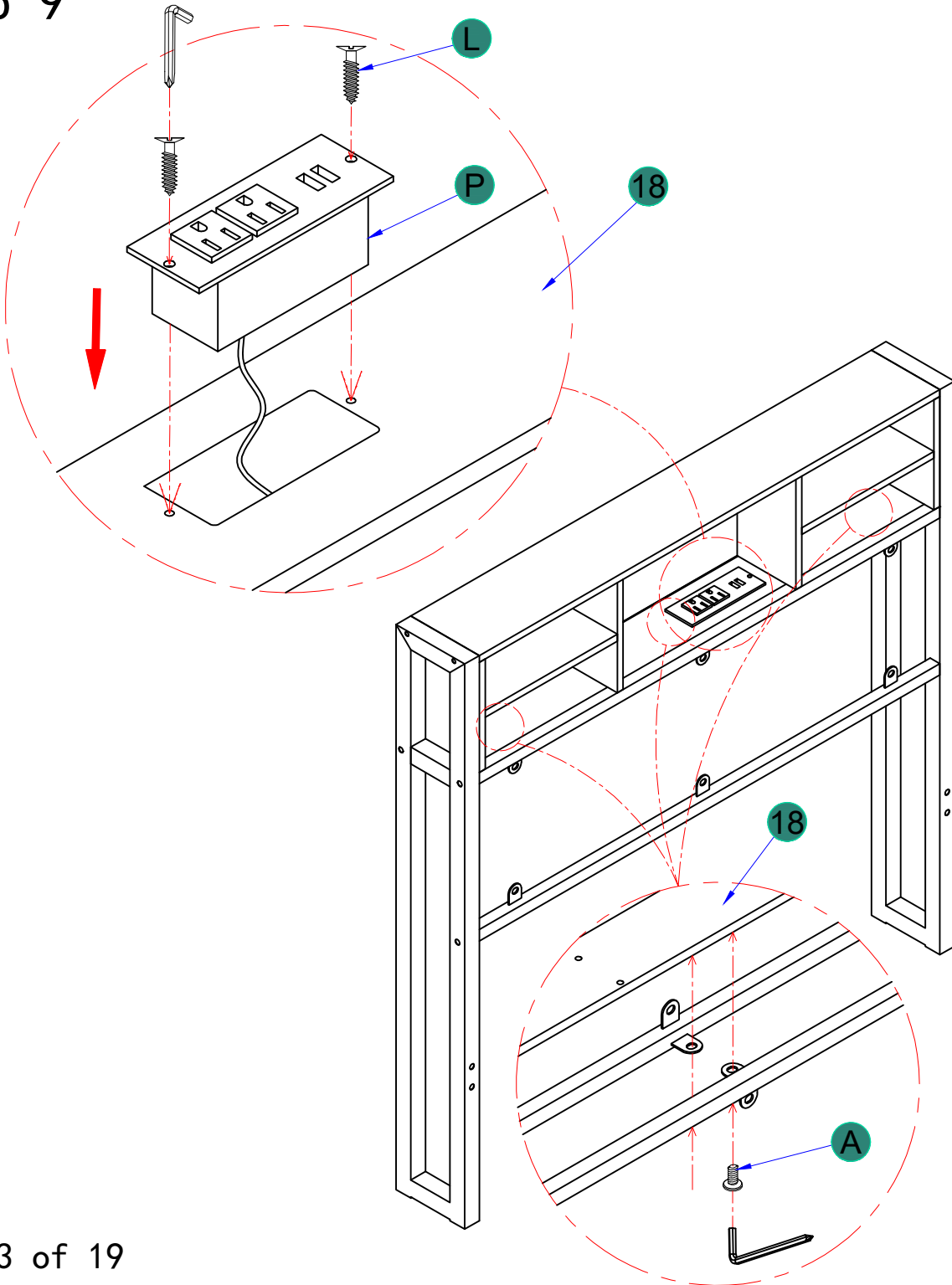

# ASSEMBLY



ⓓ 6PCS

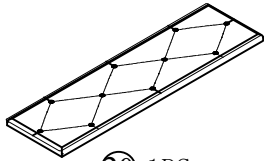

⑳ 1PC

## Step 10

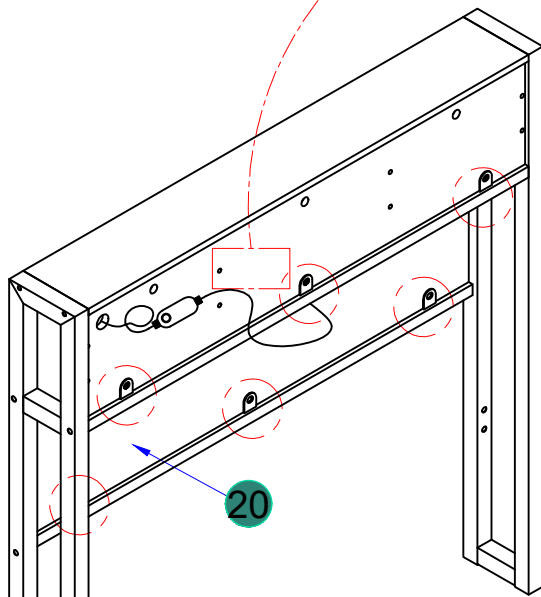
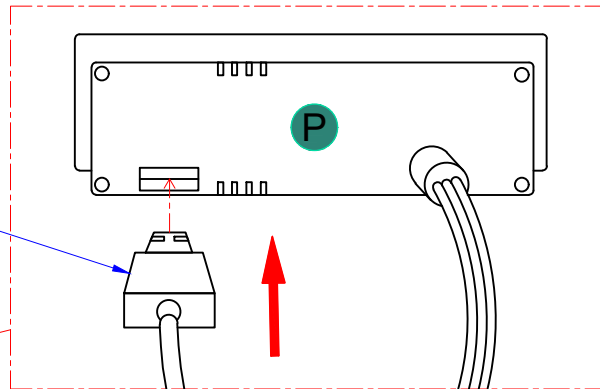

⑳

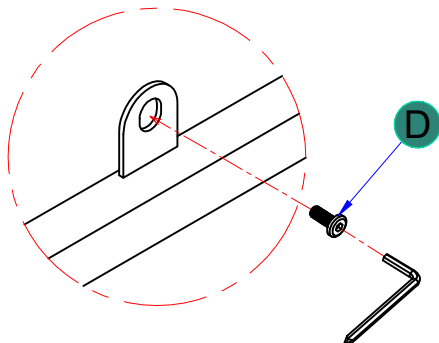
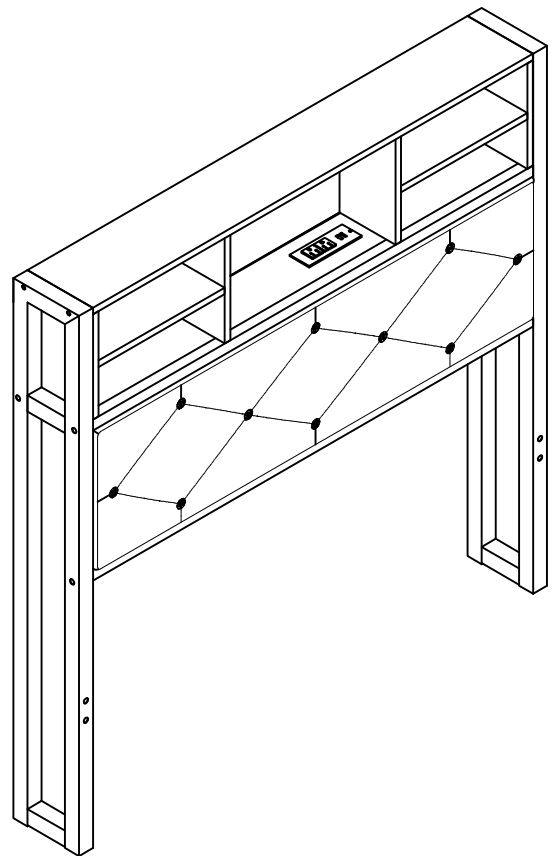

ⓓ

# ASSEMBLY

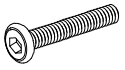

Ⓑ 4PCS



Ⓕ 4PCS



Ⓖ 4PCS

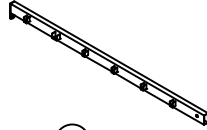

Ⓔ 2PCS

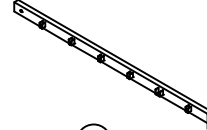

Ⓕ 2PCS

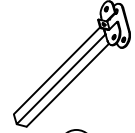

Ⓖ 2PCS

## Step 11

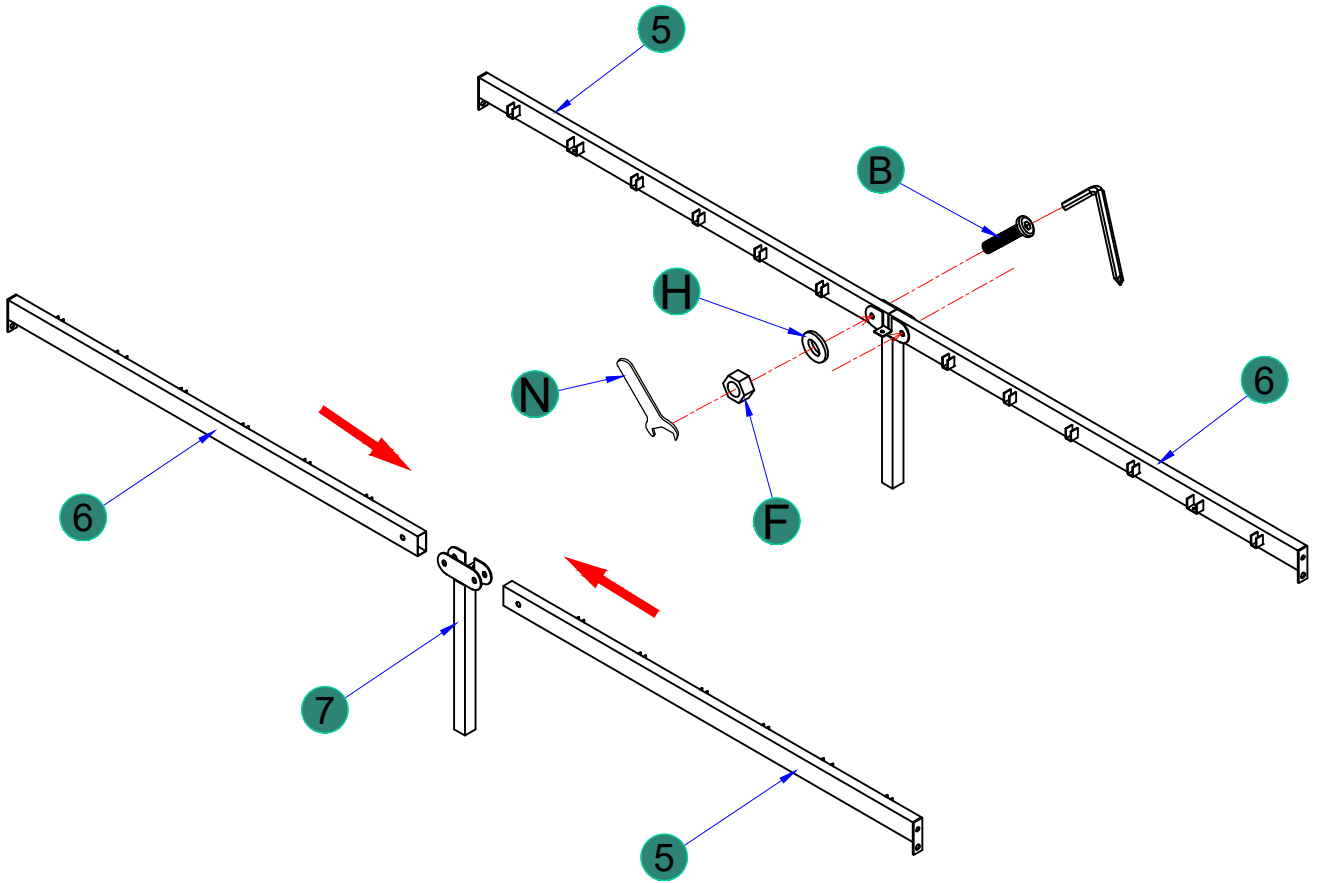

# ASSEMBLY



A 6PCS



E 8PCS



G 4PCS



H 8PCS

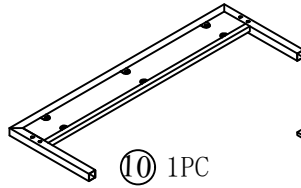

10 1PC

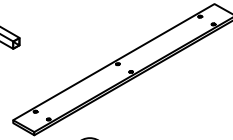

19 1PC

## Step 12

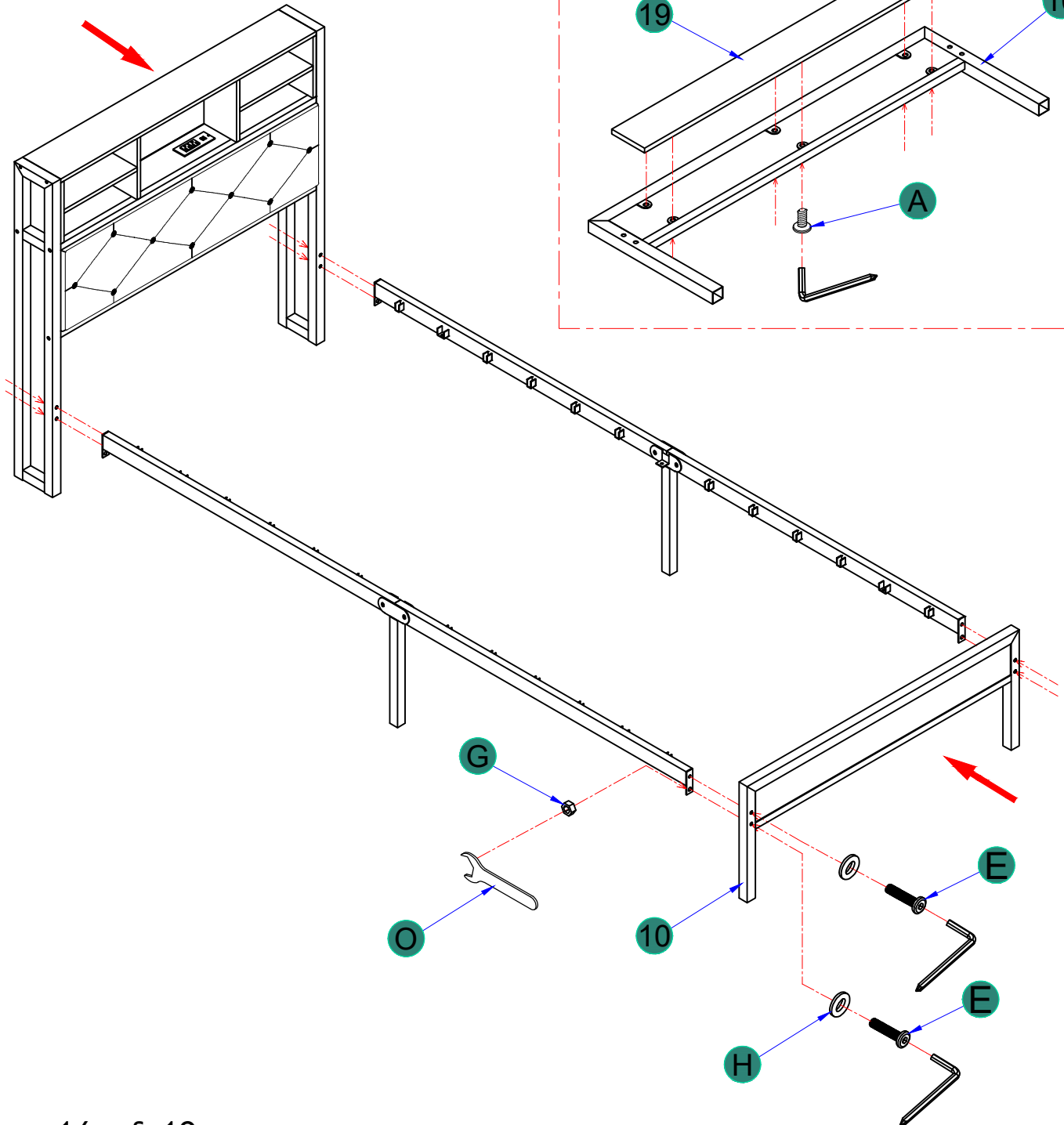

# ASSEMBLY



Ⓑ 6PCS



Ⓘ 3PCS

## Step 13

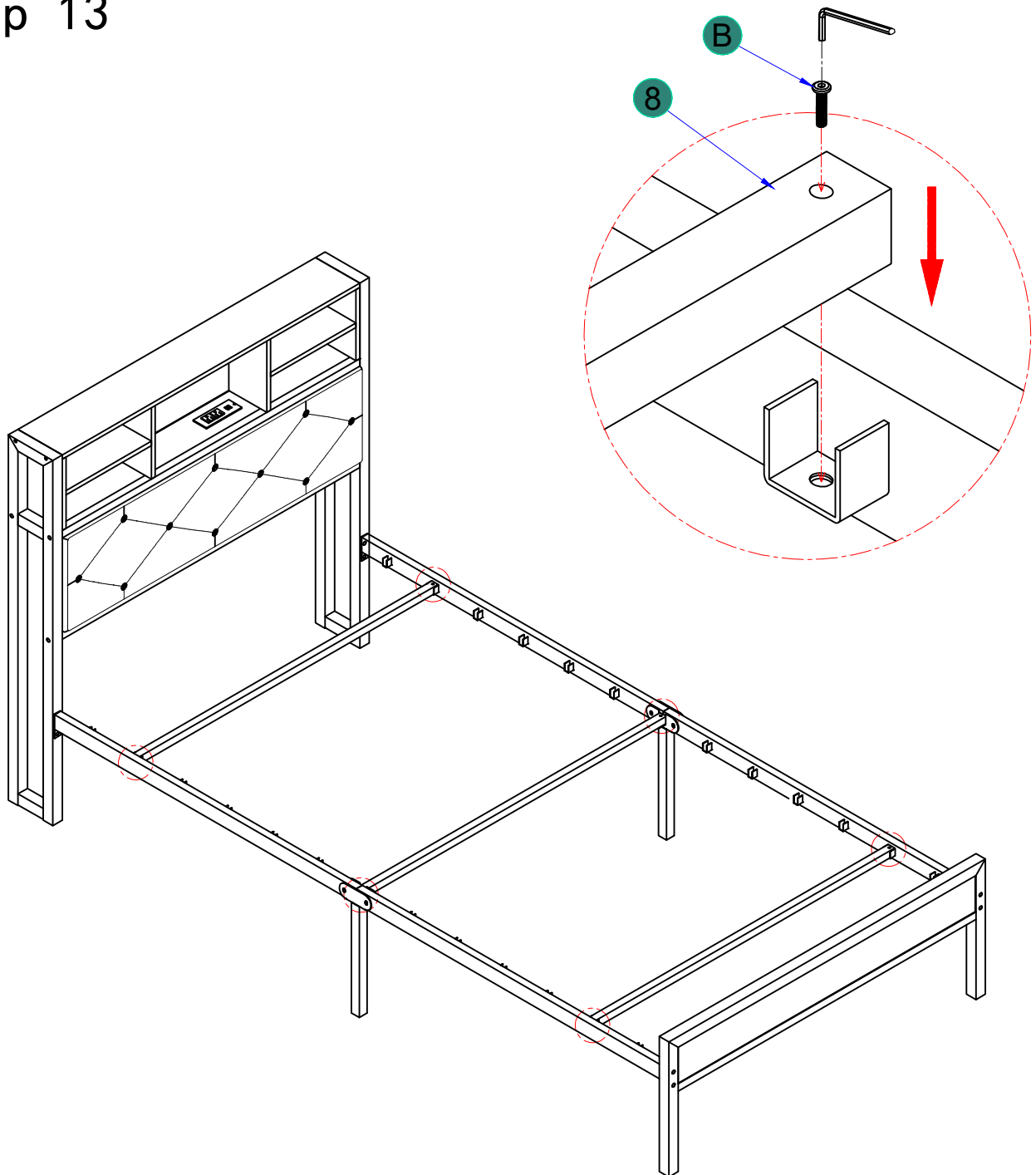

# ASSEMBLY

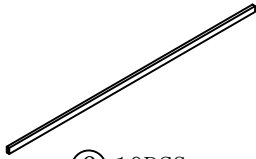

⑨ 10PCS

## Step 14

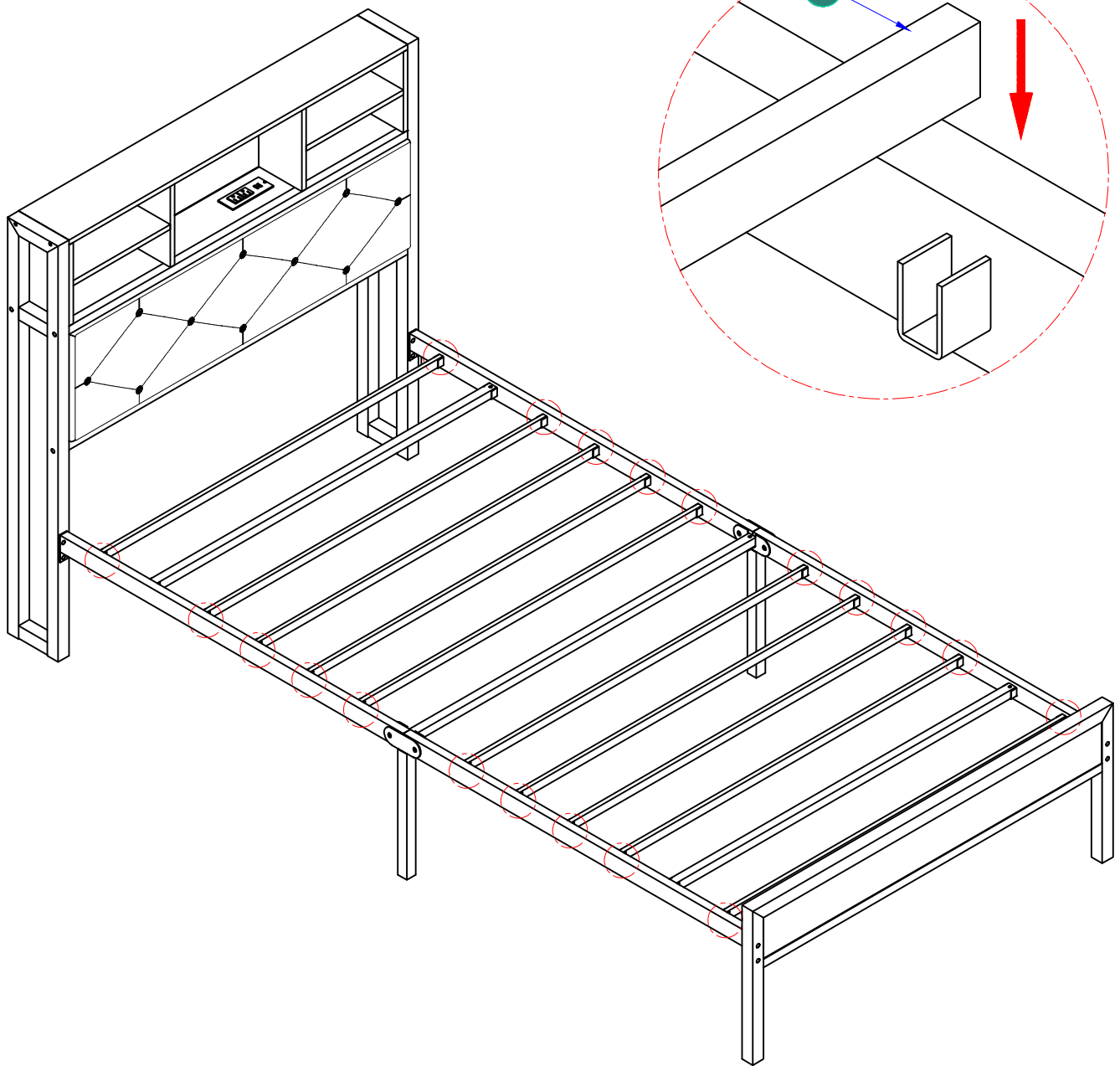

# ASSEMBLY

