

Owner Manual

Product Dimensions : 18.1"W X 14.3"D X 72.04"H

NOTICE

*Please make sure that you have all the listed parts and check if they are in a good condition before you assemble this item. Please refer to parts and hardware listed below for guidance.

*This item should be assembled on a soft surface to prevent any scratch on the finish when assembling the item.

*This item may require a periodic tightening.

PREPARATION

* Before assembling the product, make sure you have all the complete parts. Compare the parts you have to the parts listed here.

* If any part is missing or damaged, do not attempt to assemble the product.

* The Estimated Time for Assembly: 10 minutes.

* Tools Required for Assembly (included): Allen Key





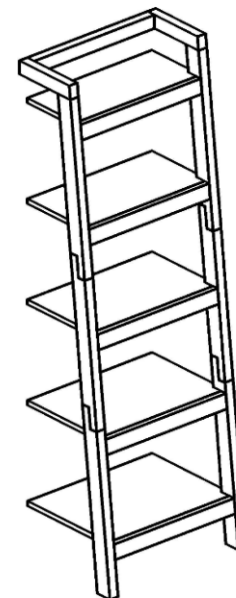



CARE AND MAINTENANCE





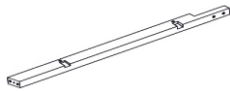

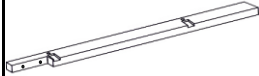

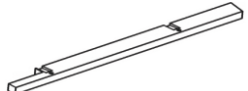
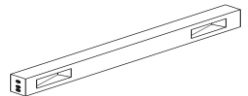

Adhesive felt pads should always be applied to areas of furniture which make direct contact with flooring, the given application will prevent damage to the furniture and or surfaces on which the furniture lies. Objects placed on the articles of furniture should rest on non-abrasive material to prevent any damage to the wood finish. Objects whose composition consists of plastic and rubber may discolor and damage the wood surfaces on which they rest. Wipe up spills immediately and avoid common hazards such as hot dishes, harsh solvents, and abrasives. Cleaning should be done with a soft lint-free cotton cloth dampened with water or furniture polish. On highly used surfaces we recommend applying a quality paste wax which should be used on a regular basis to provide additional protection from scratches and spills. How often you apply the wax depends on how much wear the furniture receives.

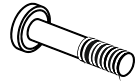

Weight capacity : 40 lbs
WARNING :DO NOT STAND ON THE PRODUCT
WARNING : DO NOT OVER TORQUE BOLTS

Part List and Hardware List

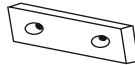
PIECE	DESCRIPTION	PICTURE	QUANTITY
A	SHELVES A		1X
B	SHELVES B		1X
C	SHELVES C		1X
D	SHELVES D		1X
E	SHELVES E		1X
F	LEFT UPPER LEG		1X
G	LEFT MIDDLE LEG		1X
H	LEFT LOWER LEG		1X
I	RIGHT UPPER LEG		1X
J	RIGHT MIDDLE LEG		1X
K	RIGHT LOWER LEG		1X
L	TOP BAR		1X

PIECE	DESCRIPTION	PICTURE	QUANTITY
M	LEFT BAR		1X
N	RIGHT BAR		1X
HW1	BOLT M6X35MM		22X
HW2	DOWEL Ø8 X 32		18X
HW3	L PLATE		1X
HW4	FISHER S6		1X
HW5	ALLEN KEY L.4		1X
HW6	SREW 8 X1 1/4		1X
HW7	SCREW 8 x 5/8		1X
HW8	METAL PLATE		2X
HW9	SCREW 8 x 1/2		4X
HW10	FLAT WASHER 6MM		22X

PREPARATION

- * Before assembling the product, make sure you have all the complete parts. Compare the parts you have to the parts listed here.
- * If any part is missing or damaged, do not attempt to assemble the product.
- * The Estimated Time for Assembly: 10 minutes.
- * Tools Required for Assembly (included): Allen Key

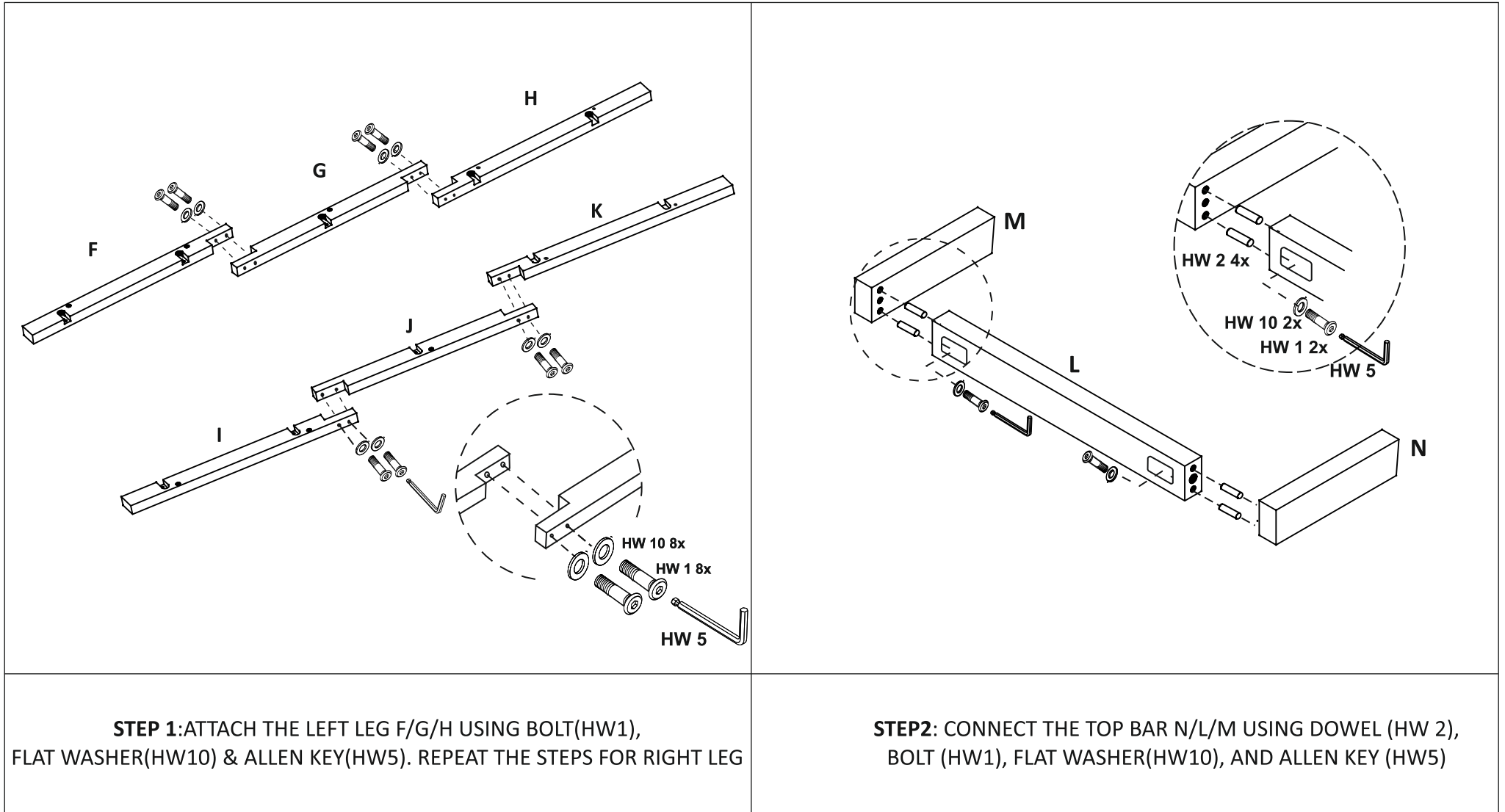

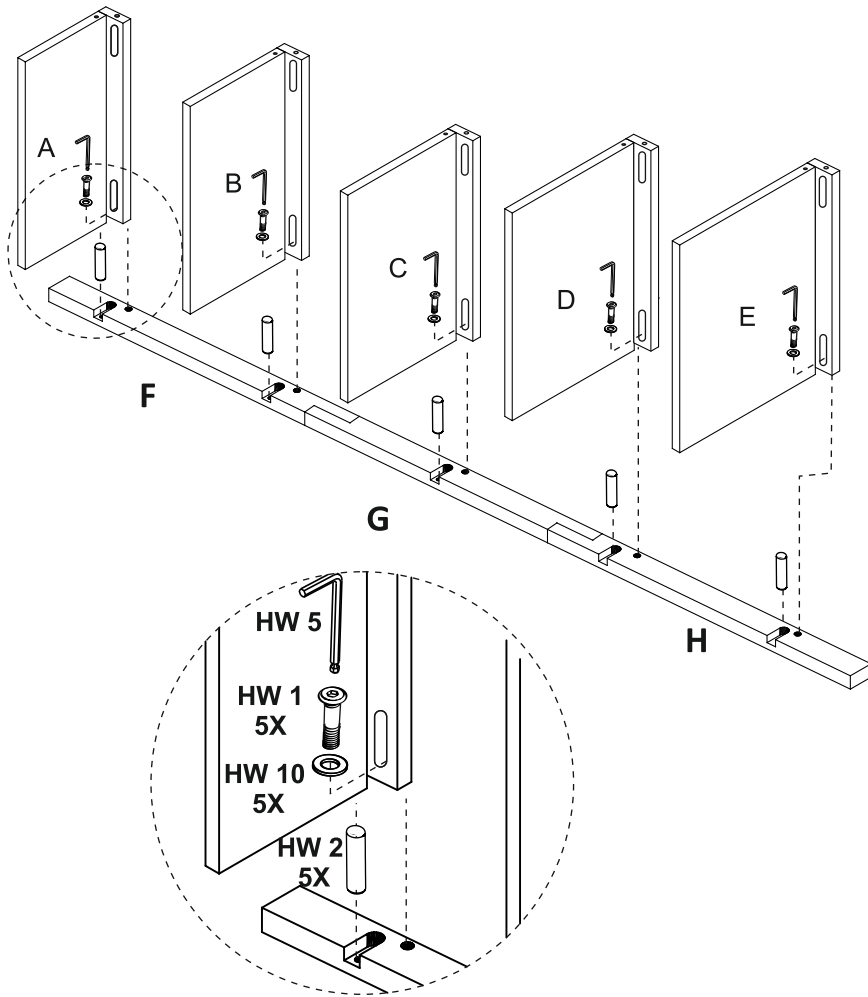

STEP 3: ATTACH SHELVES A/B/C/D/E TO THE LEFT LEG USING DOWEL(HW2), BOLT(HW1),FLAT WASHER(HW10) & ALLEN KEY(HW5)

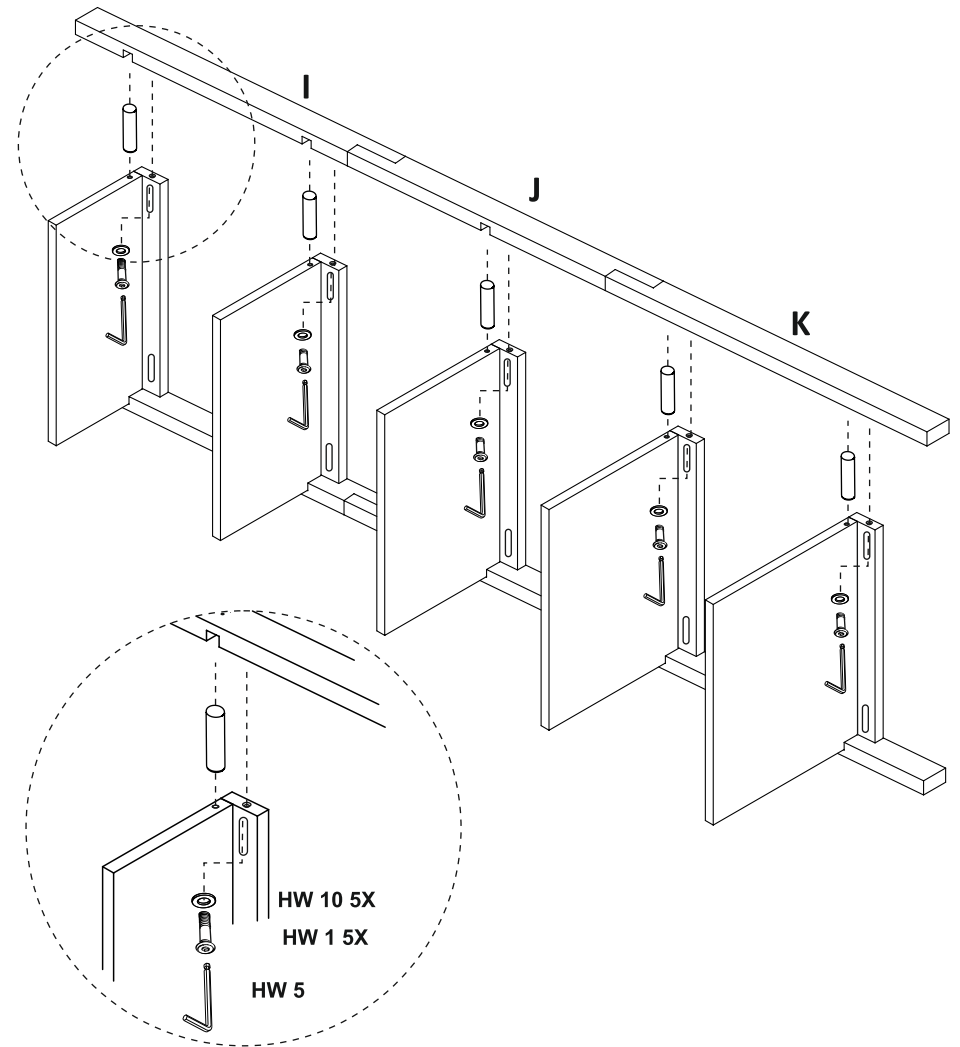

STEP 4: INSERT SHELVES A/B/C/D/E TO THE RIGHT LEG USING DOWEL(HW2), BOLT(HW1),FLAT WASHER(HW10) AND ALLEN KEY(HW5)

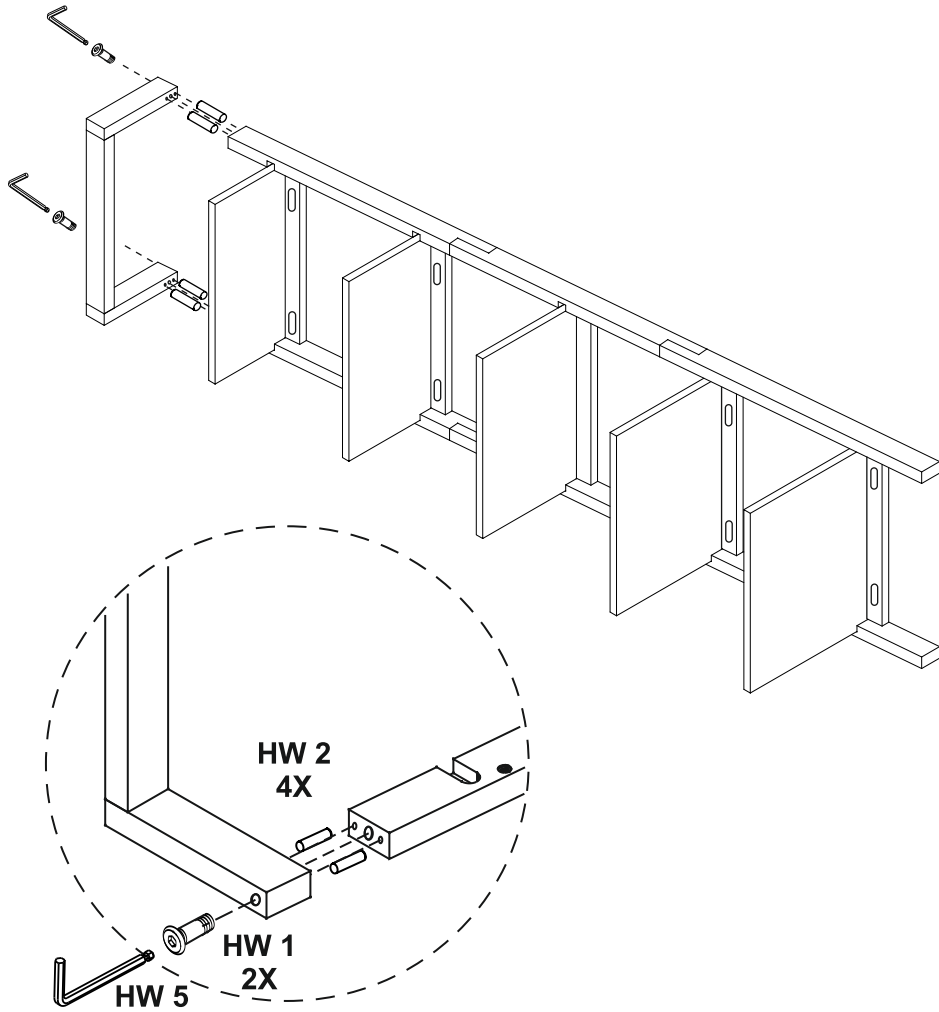

STEP 5: INSERT TOP BAR TO LEFT/RIGHT LEG. USING DOWEL(HW2), BOLT(HW1), FLAT WASHER (HW10) AND ALLEN KEY(HW5).

WALL

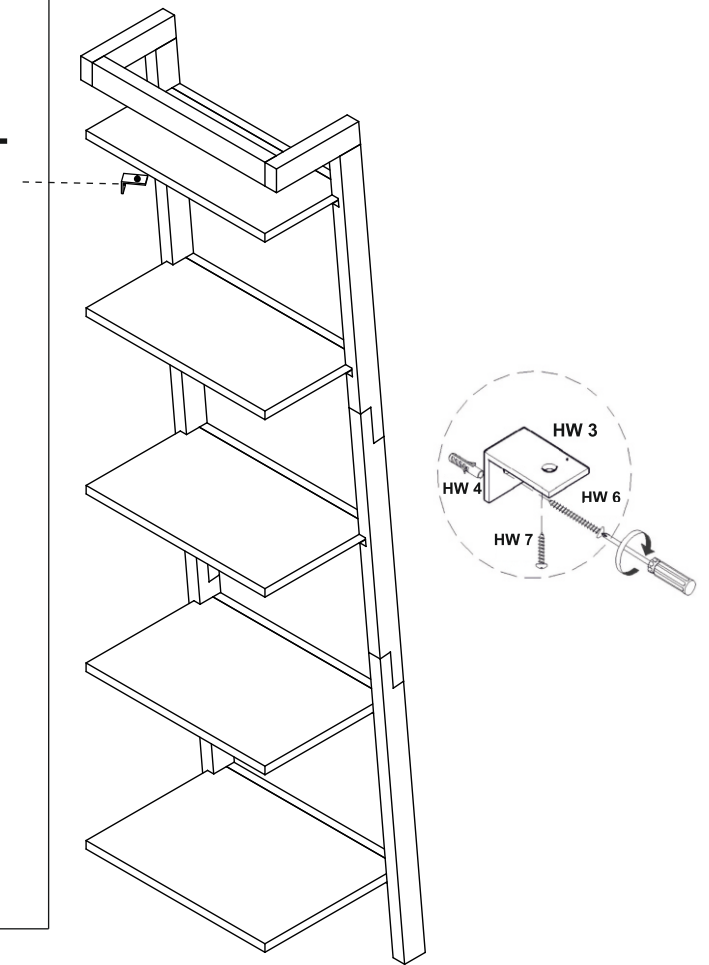

STEP 6 : ATTACH ANTI -TIP KIT TO HELP PREVENT ETERAGE FROM TIPPING

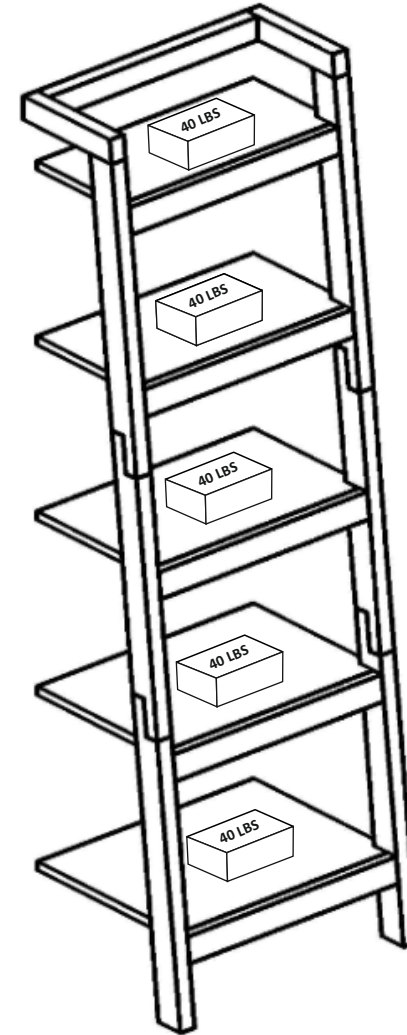
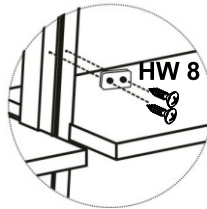
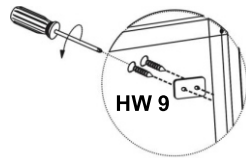
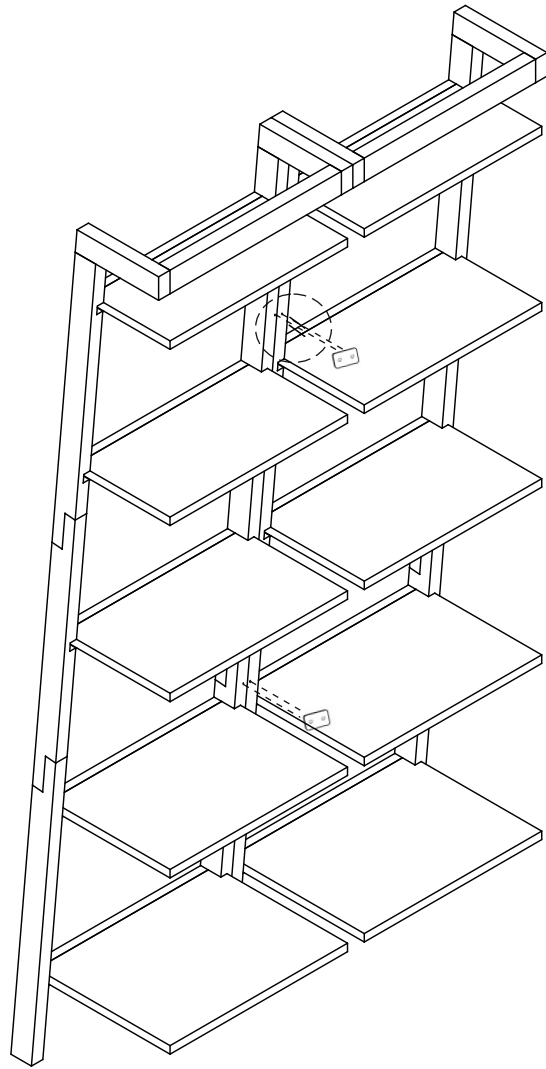

STEP 7 : THIS IS APPLICABLE ONLY TO A PAIR OF ETAGERE.
SKIP THIS INSTRUCTIONS IF YOU BUY A SINGLE ITEM .

MAXIMUM WEIGHT